



Tooling by
DIJET[®]
PRODUCT GUIDE

Vol. 4
2023~2024





- All cutter-holders are supplied without Inserts , Wrench & MOLY.
- Specifications for the products listed in this catalog are subject to change without notice due to replacement or modification.

ABOUT STOCK

- : Stocked Items
- : Stock in JAPAN

CUTTING STYLE ICON

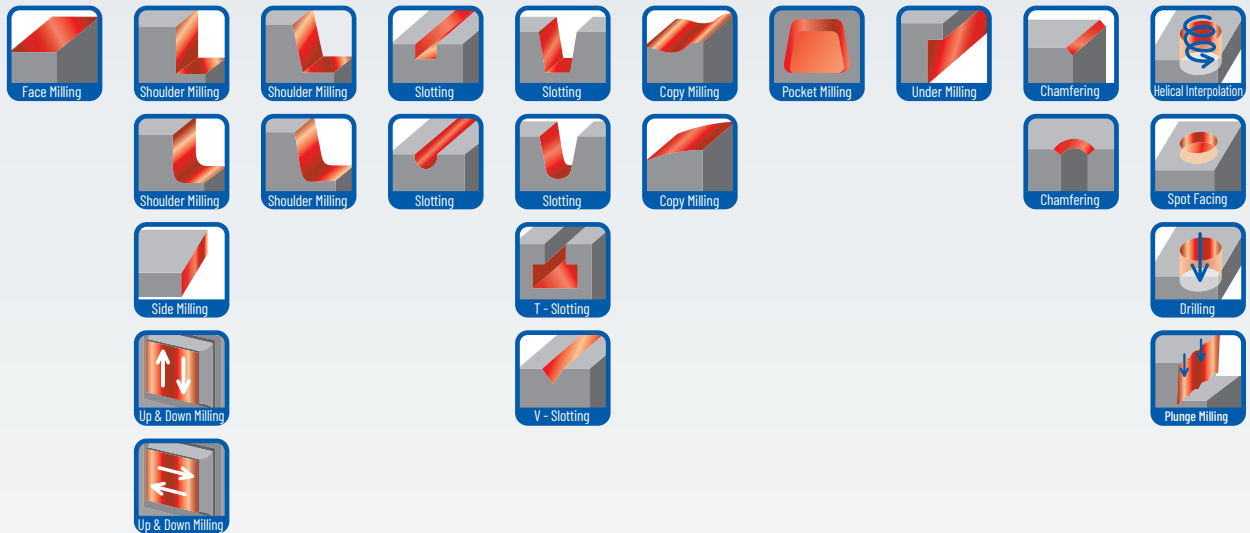

COATING ICON



TYPE OF MACHINING



CORNER SHAPE



OTHERS



G-BODY is a GN surface-hardening treatment on thermal resistant high strength steel giving a hardness over 65HRC and secures insert pocket and holder against thermal deformation improving body durability.













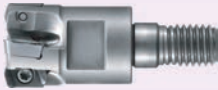

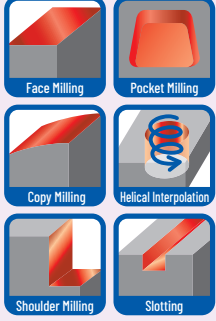

Carbide shank provides much lower deflection than steel shank , that enables maximum tool life and highest productivity.

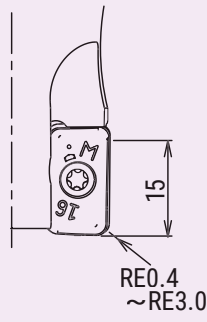

INDEXABLE TOOLS

MILLING TOOLS QUICK GUIDE

Type	Item Code	Shape / Tool dia.	Cutting edge angle / Max.DOC	Applications						
HIGH FEED - COPY MILLING	SKS-GII	<table border="1"> <tr> <td>O.D.</td> <td>0</td> <td>Insert</td> </tr> <tr> <td>Tolerance</td> <td>-0.1</td> <td>N.E.M Class</td> </tr> </table> <p>G-Body</p>	O.D.	0	Insert	Tolerance	-0.1	N.E.M Class		
	O.D.	0	Insert							
	Tolerance	-0.1	N.E.M Class							
MSG Type										
A051	φ25~φ42									
HIGH FEED - COPY MILLING	SKS-GII-09	<table border="1"> <tr> <td>O.D.</td> <td>0</td> <td>Insert</td> </tr> <tr> <td>Tolerance</td> <td>-0.1</td> <td>E Class</td> </tr> </table> <p>G-Body</p>	O.D.	0	Insert	Tolerance	-0.1	E Class		
	O.D.	0	Insert							
	Tolerance	-0.1	E Class							
MSG-09 Type										
A068	φ20~φ42									
HIGH FEED - COPY MILLING	SKS EXTREME	<table border="1"> <tr> <td>O.D.</td> <td>-0.05</td> <td>Insert</td> </tr> <tr> <td>Tolerance</td> <td>-0.15</td> <td>M Class</td> </tr> </table> <p>G-Body</p>	O.D.	-0.05	Insert	Tolerance	-0.15	M Class		
	O.D.	-0.05	Insert							
	Tolerance	-0.15	M Class							
MEX-07 Type										
A082	φ32~φ42									
HIGH FEED - COPY MILLING	SKS EXTREME	<table border="1"> <tr> <td>O.D.</td> <td>-0.05</td> <td>Insert</td> </tr> <tr> <td>Tolerance</td> <td>-0.15</td> <td>M Class</td> </tr> </table> <p>G-Body</p>	O.D.	-0.05	Insert	Tolerance	-0.15	M Class		
	O.D.	-0.05	Insert							
	Tolerance	-0.15	M Class							
MEX-05 Type										
A080	φ20~φ40									
HIGH FEED - COPY MILLING	QM MAX GII	<table border="1"> <tr> <td>O.D.</td> <td>-0.05</td> <td>Insert</td> </tr> <tr> <td>Tolerance</td> <td>-0.15</td> <td>M Class</td> </tr> </table> <p>G-Body</p>	O.D.	-0.05	Insert	Tolerance	-0.15	M Class		
	O.D.	-0.05	Insert							
	Tolerance	-0.15	M Class							
MXG Type										
A107	φ16~φ42									

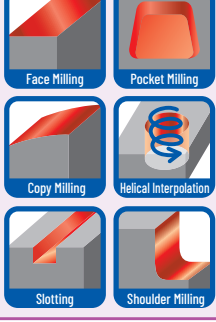









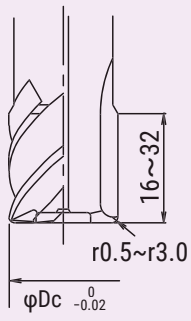



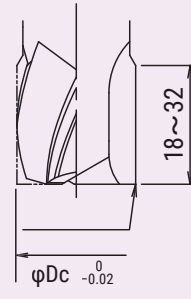



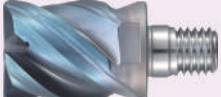
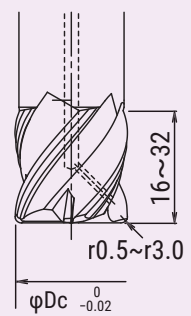

Type	Item Code	Shape / Tool dia.	Cutting edge angle / Max.DOC	Applications
HIGH FEED - COPY MILLING	QM MAX	 G-Body Insert H, M Class	 High feed O.D. Tolerance: -0.06, -0.14 RE1.2~RE2.0	
	MQX Type			
	A123			
HIGH FEED - COPY MILLING	QM MILL	 G-Body Insert H, M Class	 High feed O.D. Tolerance: -0.05, -0.15 RE1.0~RE2.0	
	MPM			
	A182			
SHOULDER MILLING	EXTREME SAP	 O.D. Tolerance: -0.04, -0.1 Insert G Class		
	MSX-11 Type			
	A204			
SHOULDER MILLING	EXTREME SAP	 G-Body Insert G Class		
	MSX-17 Type			
	A208			
SHOULDER MILLING	SIC-EVO	 O.D. Tolerance: -0.05, -0.15 Insert M Class		
	SSV Type			
	A247			





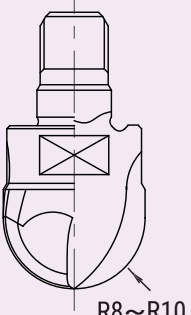

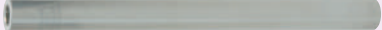

MILLING TOOLS QUICK GUIDE

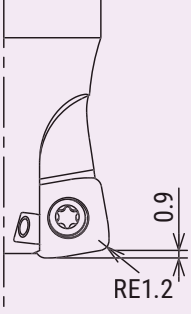
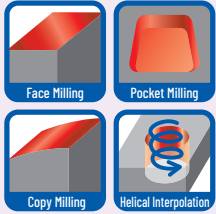
Type	Item Code	Shape / Tool dia.	Cutting edge angle / Max.DOC	Applications									
FINISHING • COPY MILLING	MIRROR BALL	O.D. Tolerance ± 0.008 Insert F Class	<p>R5~R16</p>										
	MBX Type												
	A272					$\phi 10 \sim \phi 30$							
FINISHING • COPY MILLING	MIRROR RADIUS	O.D. Tolerance -0.002 to -0.018 Insert F Class	<p>RE0~RE3.0</p>										
	MRX Type												
	A285					$\phi 10 \sim \phi 32$							
FINISHING • UP & DOWN MILLING	BACK & FORTH CUTTER	O.D. Tolerance $+0.1$ to -0.3 Insert G Class			<p>WEB CATALOGUE</p>								
	MPF Type												
	Available only on WEB CATALOGUE					$\phi 30 \sim \phi 40$							
FINISHING • COPY MILLING	DIEMASTER 5G	O.D. Tolerance -0.0 to -0.05 Insert H Class	<p>RE 1.0</p>										
	MXF Type												
	A303					$\phi 16 \sim \phi 42$							
ROUGHING • COPY MILLING	SWING BALL	<table border="1"> <thead> <tr> <th>Tool dia.</th> <th>O.D. Tolerance</th> </tr> </thead> <tbody> <tr> <td>$\phi 16$</td> <td>0 to -0.1</td> </tr> <tr> <td>$\phi 20, \phi 25$</td> <td>-0.01 to -0.11</td> </tr> <tr> <td>$\phi 30$</td> <td>-0.05 to -0.15</td> </tr> </tbody> </table>	Tool dia.	O.D. Tolerance	$\phi 16$	0 to -0.1	$\phi 20, \phi 25$	-0.01 to -0.11	$\phi 30$	-0.05 to -0.15	<p>R8~R15</p>		<p>WEB CATALOGUE</p>
	Tool dia.	O.D. Tolerance											
	$\phi 16$	0 to -0.1											
$\phi 20, \phi 25$	-0.01 to -0.11												
$\phi 30$	-0.05 to -0.15												
MSWX Type													
Available only on WEB CATALOGUE		$\phi 16 \sim \phi 30$											

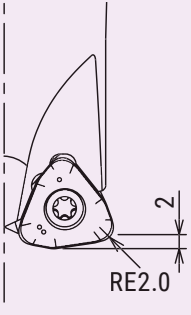
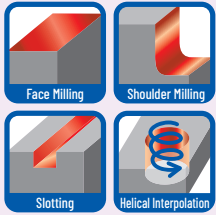

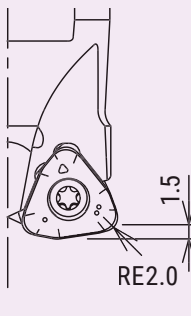
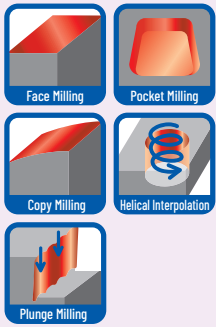

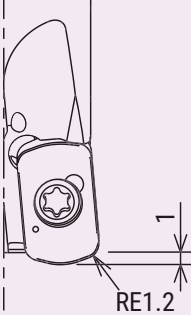
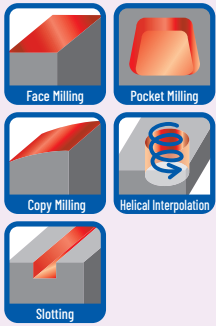

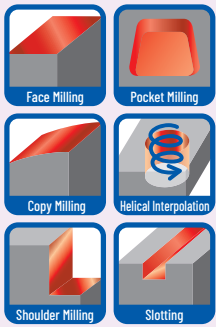
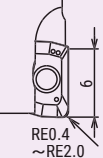







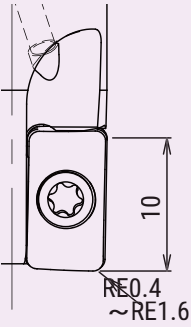











Type	Item Code	Shape / Tool dia.	Cutting edge angle / Max.DOC	Applications	
ROUGHING • COPY MILLING	SWING BALL	O.D. -0.05 Tolerance -0.15 Insert G Class G-Body			WEB CATALOGUE
	MSW Type				
	Available only on WEB CATALOGUE	$\phi 32$			
COPY MILLING	SUPER DIEMASTER	O.D. 0 Tolerance -0.1 Insert G, M Class G-Body			
	SDH Type				
	A322	$\phi 15 \sim \phi 42$			
COPY MILLING	EXTREME DIEMASTER	O.D. 0 Tolerance -0.1 Insert M Class G-Body			WEB CATALOGUE
	MTX Type				
	Available only on WEB CATALOGUE	$\phi 32 \sim \phi 40$			
For ALUMINIUM ALLOY	AERO CHIPPER	O.D. 0 Tolerance -0.1 Insert G Class G-Body			
	MAL Type				
	A357	$\phi 20 \sim \phi 40$			
FINISHING SIDE & BOTTOM FACE	BACK DRAFT CUTTER	O.D. 0 Tolerance -0.1 Insert H Class G-Body			WEB CATALOGUE
	MDB Type				
	Available only on WEB CATALOGUE	$\phi 20 \sim \phi 40$			

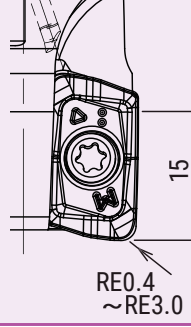









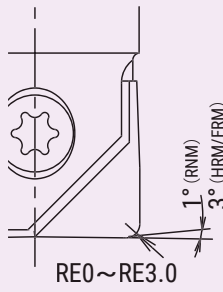





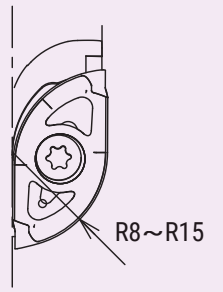





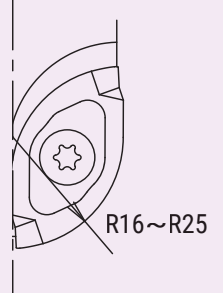





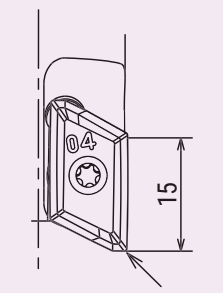



MILLING TOOLS QUICK GUIDE

Type	Item Code	Shape / Tool dia.	Cutting edge angle / Max.DOC	Applications
MULTI-EDGES	S-HEAD	 $\phi 16 \sim \phi 32$	 $\phi Dc \begin{smallmatrix} 0 \\ -0.02 \end{smallmatrix}$	  
	SMSA Type			
	A364			
For ALUMINIUM ALLOY	S-HEAD	 $\phi 18 \sim \phi 32$	 $\phi Dc \begin{smallmatrix} 0 \\ -0.02 \end{smallmatrix}$	    
	SMAL Type			
	A369			
For HEAT RESISTANT ALLOY	S-HEAD	 $\phi 16 \sim \phi 32$	 $\phi Dc \begin{smallmatrix} 0 \\ -0.02 \end{smallmatrix}$	   
	SMSR Type			
	A371			
For HARDENED MATERIALS	S-HEAD	 $\phi 16 \sim \phi 20$	 $R8 \sim R10$	 
	SMHB Type			
	A374			
FOR HIGH EFFICIENCY MACHINING	CARBIDE SHANK	 Endmill Shank Type $\phi 10 \sim \phi 32$		
	MSN Type	 Straight Type $\phi 9.8 \sim \phi 32$		
	A375			

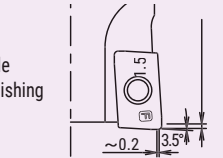







Type	Item Code	Shape / Tool dia.	Cutting edge angle / Max.DOC	Applications
HIGH FEED • COPY MILLING	SKS-GII-09	 O.D. Tolerance: 0 / -0.1 Insert: E Class φ25~φ35	 RE1.2 0.9	
	SKG-09 Type			
	A067			
HIGH FEED • COPY MILLING	SKS EXTREME	 O.D. Tolerance: -0.05 / -0.15 Insert: M Class φ32~φ40	 RE2.0 2	
	EXSKS-07 Type			
	A083			
HIGH FEED • COPY MILLING	SKS EXTREME	 O.D. Tolerance: -0.05 / -0.15 Insert: M Class φ20~φ32	 RE2.0 1.5	
	EXSKS-05 Type			
	A081			
HIGH FEED • COPY MILLING	QM MAX GII	 O.D. Tolerance: -0.05 / -0.15 Insert: M Class φ16~φ32	 RE1.2 1	
	GMX Type			
	A106			
HIGH FEED • COPY MILLING	QM MAX	 Insert: H, M Class φ16~φ25	High Feed O.D. Tolerance: -0.06 / -0.14  RE1.2 ~ RE2.0 0.8	
	QXP Type		Shoulder Milling O.D. Tolerance: -0.03 / -0.11  RE0.4 ~ RE2.0 6	
	A122			

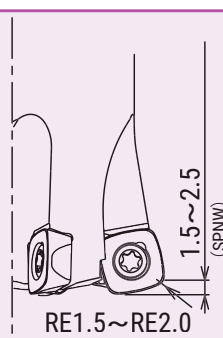
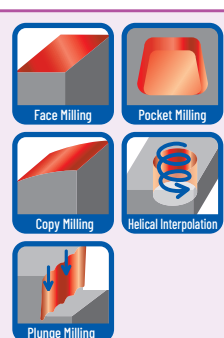

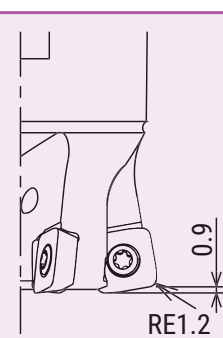
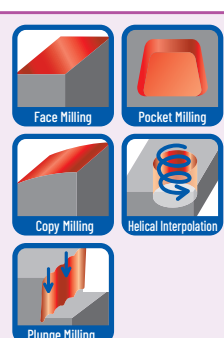

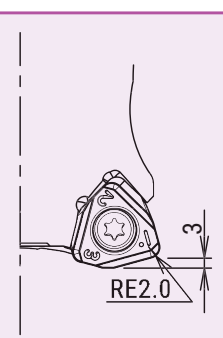
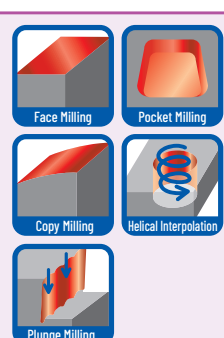

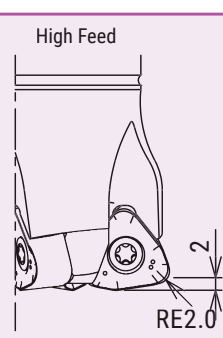
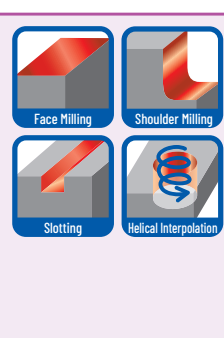

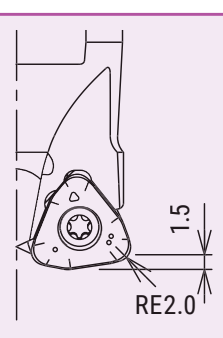
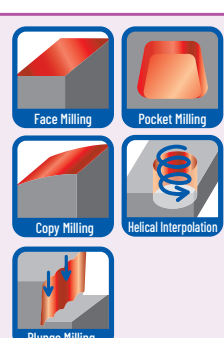

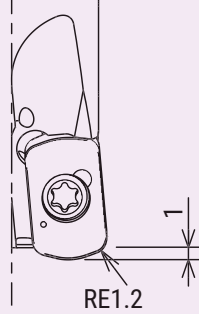





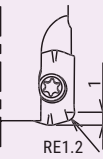
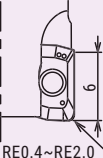







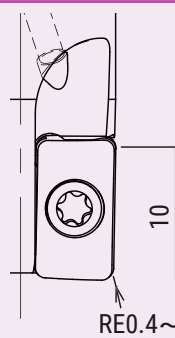



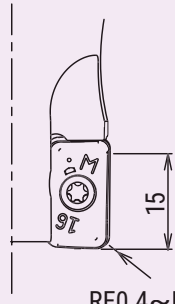

MILLING TOOLS QUICK GUIDE

Type	Item Code	Shape / Tool dia.	Cutting edge angle / Max.DOC	Applications
HIGH FEED • COPY MILLING	QM MILL	 φ10~φ14	High Feed O.D. Tolerance -0.05 -0.15 RE1.0~RE2.0 Shoulder Milling O.D. Tolerance -0.02 -0.12 RE0.2~RE0.8	     
	PME Type			
	A181			
SHOULDER MILLING	EXTREME SAP	 φ16~φ32	O.D. Tolerance -0.03 -0.11 Insert G Class RE0.4 ~ RE1.6	    
	EXSAP-11 Type			
	A203			
SHOULDER MILLING	EXTREME SAP	 φ25~φ32	O.D. Tolerance -0.05 -0.15 Insert G Class RE0.4 ~ RE3.0	    
	EXSAP-17 Type			
	A207			
SHOULDER MILLING	SIC-EVO	 φ25~φ40	O.D. Tolerance -0.05 -0.15 Insert M Class RE0.4 ~ RE3.0	     
	SSV Type			
	A248			
FINISHING • COPY MILLING	MIRROR BALL	 φ6~φ30	O.D. Tolerance ±0.008 Insert F Class R3~R16	  
	BNM Type			
	A270			

Type	Item Code	Shape / Tool dia.	Cutting edge angle / Max.DOC	Applications																					
FINISHING • COPY MILLING	MIRROR RADIUS	<table border="1"> <tr> <td>O.D.</td> <td>-0.002</td> <td>Insert</td> <td>F Class</td> </tr> <tr> <td>Tolerance</td> <td>-0.018</td> <td></td> <td></td> </tr> </table> 	O.D.	-0.002	Insert	F Class	Tolerance	-0.018			 <p>1° (RNM) 3° (HRM/FRM) RE0~RE3.0</p>	    													
	O.D.	-0.002	Insert	F Class																					
	Tolerance	-0.018																							
RNM Type																									
A283	φ6~φ32																								
ROUGHING • COPY MILLING	SWING BALL	<table border="1"> <tr> <td>Toll dia.</td> <td>O.D.</td> <td>Insert</td> <td>G Class</td> </tr> <tr> <td>φ16</td> <td>0</td> <td></td> <td></td> </tr> <tr> <td>φ20,φ25</td> <td>-0.01</td> <td></td> <td></td> </tr> <tr> <td>φ30</td> <td>-0.05</td> <td></td> <td></td> </tr> <tr> <td></td> <td>-0.15</td> <td></td> <td></td> </tr> </table> 	Toll dia.	O.D.	Insert	G Class	φ16	0			φ20,φ25	-0.01			φ30	-0.05				-0.15			 <p>R8~R15</p>	  	<p>WEB CATALOGUE</p> 
	Toll dia.	O.D.	Insert	G Class																					
	φ16	0																							
φ20,φ25	-0.01																								
φ30	-0.05																								
	-0.15																								
SWBX Type																									
Available only on WEB CATALOGUE	φ16~φ30																								
ROUGHING • COPY MILLING	SWING BALL	<table border="1"> <tr> <td>O.D.</td> <td>-0.05</td> <td>Insert</td> <td>G Class</td> </tr> <tr> <td>Tolerance</td> <td>-0.15</td> <td></td> <td></td> </tr> </table> 	O.D.	-0.05	Insert	G Class	Tolerance	-0.15			 <p>R16~R25</p>	  	<p>WEB CATALOGUE</p> 												
	O.D.	-0.05	Insert	G Class																					
	Tolerance	-0.15																							
SWB Type																									
Available only on WEB CATALOGUE	φ32~φ50																								
For ALUMINIUM ALLOY	AERO CHIPPER	<table border="1"> <tr> <td>O.D.</td> <td>0</td> <td>Insert</td> <td>G Class</td> </tr> <tr> <td>Tolerance</td> <td>-0.1</td> <td></td> <td></td> </tr> </table> 	O.D.	0	Insert	G Class	Tolerance	-0.1			 <p>15 RE0.2~4.0</p>	    													
	O.D.	0	Insert	G Class																					
	Tolerance	-0.1																							
ALX Type																									
A356	φ20~φ40																								
FINISHING SIDE & BOTTOM FACE	BACK DRAFT CUTTER	<table border="1"> <tr> <td>O.D.</td> <td>0</td> <td>Insert</td> <td>H Class</td> </tr> <tr> <td>Tolerance</td> <td>-0.1</td> <td></td> <td></td> </tr> </table> 	O.D.	0	Insert	H Class	Tolerance	-0.1			<p>Bottom Finishing</p>  <p>0.05~0.3 3.5°</p> <p>Side Finishing</p>  <p>~0.2 3.5°</p>	    	<p>WEB CATALOGUE</p> 												
	O.D.	0	Insert	H Class																					
	Tolerance	-0.1																							
DBD Type																									
Available only on WEB CATALOGUE	φ40																								

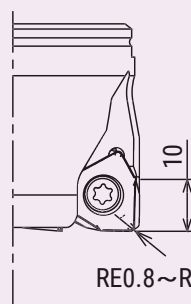









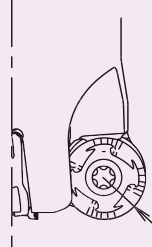







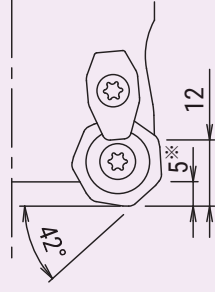







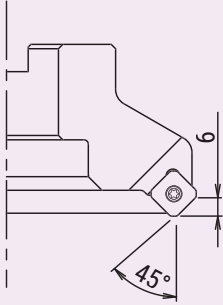



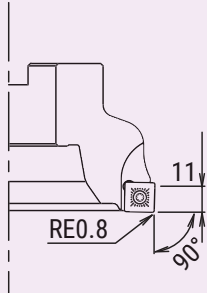

MILLING TOOLS QUICK GUIDE

Type	Item Code	Shape / Tool dia.	Cutting edge angle / Max.DOC	Applications
HIGH FEED • COPY MILLING	SKS-II	 <p>O.D. -0.05 Tolerance -0.15 Insert N, M Class</p> <p>G-Body</p> <p>$\phi 50 \sim \phi 160$</p>	 <p>1.5~2.5 (SPNW)</p> <p>RE1.5~RE2.0</p>	
	SKG Type			
	A050			
HIGH FEED • COPY MILLING	SKS-II-09	 <p>O.D. -0.05 Tolerance -0.15 Insert E Class</p> <p>G-Body</p> <p>$\phi 40 \sim \phi 80$</p>	 <p>0.9</p> <p>RE1.2</p>	
	SKG-09 Type			
	A066			
HIGH FEED • COPY MILLING	SKS EXTREME	 <p>O.D. 0 Tolerance -0.2 Insert M Class</p> <p>G-Body</p> <p>$\phi 50 \sim \phi 160$</p>	 <p>3</p> <p>RE2.0</p>	
	EXSKS-09 Type			
	A084			
HIGH FEED • COPY MILLING	SKS EXTREME	 <p>O.D. -0.05 Tolerance -0.15 Insert M Class</p> <p>G-Body</p> <p>$\phi 50 \sim \phi 80$</p>	<p>High Feed</p>  <p>2</p> <p>RE2.0</p>	
	EXSKS-07 Type			
	A082			
HIGH FEED • COPY MILLING	SKS EXTREME	 <p>O.D. -0.05 Tolerance -0.15 Insert M Class</p> <p>G-Body</p> <p>$\phi 40 \sim \phi 63$</p>	 <p>1.5</p> <p>RE2.0</p>	
	EXSKS-05 Type			
	A080			

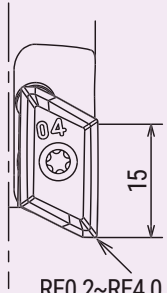









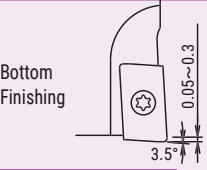



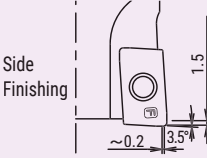

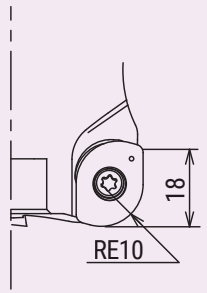

Type	Item Code	Shape / Tool dia.	Cutting edge angle / Max.DOC	Applications												
HIGH FEED • COPY MILLING	QM MAX GII	<table border="1"> <tr> <td>O.D.</td> <td>-0.05</td> <td rowspan="2">Insert M Class</td> </tr> <tr> <td>Tolerance</td> <td>-0.15</td> </tr> </table> <p>G-Body</p>  <p>φ50~φ66</p>	O.D.	-0.05	Insert M Class	Tolerance	-0.15	 <p>RE1.2</p>	    							
	O.D.		-0.05	Insert M Class												
	Tolerance		-0.15													
GMX Type																
A105																
HIGH FEED • COPY MILLING	QM MAX	<p>G-Body</p> <table border="1"> <tr> <td>Insert</td> <td>H.M Class</td> </tr> </table>  <p>φ40~φ66</p>	Insert	H.M Class	<p>High Feed</p> <table border="1"> <tr> <td>O.D.</td> <td>-0.05</td> </tr> <tr> <td>Tolerance</td> <td>-0.15</td> </tr> </table>  <p>RE1.2</p> <p>Shoulder Milling</p> <table border="1"> <tr> <td>O.D.</td> <td>-0.02</td> </tr> <tr> <td>Tolerance</td> <td>-0.12</td> </tr> </table>  <p>RE0.4~RE2.0</p>	O.D.	-0.05	Tolerance	-0.15	O.D.	-0.02	Tolerance	-0.12	     		
	Insert		H.M Class													
	O.D.		-0.05													
Tolerance	-0.15															
O.D.	-0.02															
Tolerance	-0.12															
QXP Type																
A121																
SHOULDER MILLING	EXTREME SAP	<table border="1"> <tr> <th>Tool dia.</th> <th>O.D. Tolerance</th> </tr> <tr> <td>≤ φ63</td> <td>-0.03</td> </tr> <tr> <td></td> <td>-0.11</td> </tr> <tr> <td>φ80</td> <td>-0.02</td> </tr> <tr> <td></td> <td>-0.12</td> </tr> </table>  <p>φ40~φ80</p> <table border="1"> <tr> <td>Insert</td> <td>G Class</td> </tr> </table>	Tool dia.	O.D. Tolerance	≤ φ63	-0.03		-0.11	φ80	-0.02		-0.12	Insert	G Class	 <p>RE0.4~RE1.6</p>	    
	Tool dia.		O.D. Tolerance													
	≤ φ63		-0.03													
	-0.11															
φ80	-0.02															
	-0.12															
Insert	G Class															
EXSAP-11 Type																
A202																
SHOULDER MILLING	EXTREME SAP	<table border="1"> <tr> <th>Tool dia.</th> <th>O.D. Tolerance</th> </tr> <tr> <td>≤ φ80</td> <td>-0.05</td> </tr> <tr> <td></td> <td>-0.15</td> </tr> <tr> <td>≥ φ100</td> <td>0</td> </tr> <tr> <td></td> <td>-0.2</td> </tr> </table>  <p>φ50~φ125</p> <table border="1"> <tr> <td>Insert</td> <td>G Class</td> </tr> </table>	Tool dia.	O.D. Tolerance	≤ φ80	-0.05		-0.15	≥ φ100	0		-0.2	Insert	G Class	 <p>RE0.4~RE3.0</p>	    
	Tool dia.		O.D. Tolerance													
	≤ φ80		-0.05													
	-0.15															
≥ φ100	0															
	-0.2															
Insert	G Class															
EXSAP-17 Type																
A206																
SHOULDER MILLING	SHOULDER 6	<table border="1"> <tr> <th>Tool dia.</th> <th>O.D. Tolerance</th> </tr> <tr> <td>≤ φ80</td> <td>-0.05</td> </tr> <tr> <td></td> <td>-0.15</td> </tr> <tr> <td>≥ φ100</td> <td>0</td> </tr> <tr> <td></td> <td>-0.2</td> </tr> </table>  <p>φ50~φ160</p> <table border="1"> <tr> <td>Insert</td> <td>M Class</td> </tr> </table>	Tool dia.	O.D. Tolerance	≤ φ80	-0.05		-0.15	≥ φ100	0		-0.2	Insert	M Class	 <p>RE0.8~RE1.6</p>	   
	Tool dia.		O.D. Tolerance													
	≤ φ80		-0.05													
	-0.15															
≥ φ100	0															
	-0.2															
Insert	M Class															
EXSIX Type																
A236																





MILLING TOOLS QUICK GUIDE

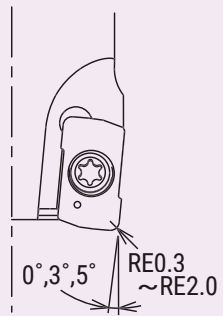



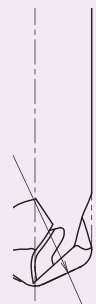





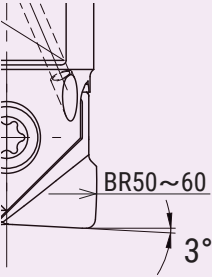





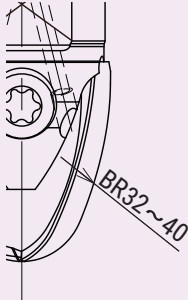



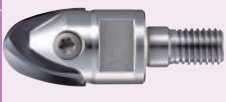
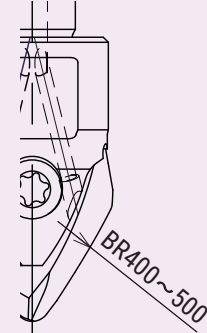



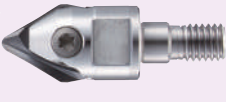
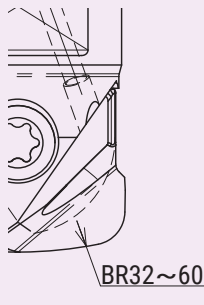

Type	Item Code	Shape / Tool dia.	Cutting edge angle / Max.DOC	Applications							
SHOULDER MILLING	SIC-EVO	<table border="1"> <tr> <th>Tool dia.</th> <th>O.D. Tolerance</th> </tr> <tr> <td>≤ φ80</td> <td>-0.05 -0.15</td> </tr> <tr> <td>≥ φ100</td> <td>-0.025 -0.175</td> </tr> </table>	Tool dia.	O.D. Tolerance	≤ φ80	-0.05 -0.15	≥ φ100	-0.025 -0.175			
	Tool dia.	O.D. Tolerance									
	≤ φ80	-0.05 -0.15									
≥ φ100	-0.025 -0.175										
SSV Type	<table border="1"> <tr> <th>Insert</th> </tr> <tr> <td>M Class</td> </tr> </table>	Insert	M Class								
Insert											
M Class											
A246	φ40~φ125										
SUPR FINISHING FOR FLAT FACE	FINISH JET MILL	<table border="1"> <tr> <th>O.D. Tolerance</th> <td>±0.2</td> <th>Insert</th> <td>H Class</td> </tr> </table>	O.D. Tolerance	±0.2	Insert	H Class			<p>WEB CATALOGUE</p>		
	O.D. Tolerance	±0.2	Insert	H Class							
	FJM Type										
Available only on WEB CATALOGUE	φ80~φ250										
FINISHING-UP & DOWN MILLING	BACK & FORTH CUTTER	<table border="1"> <tr> <th>O.D. Tolerance</th> <td>+0.1 -0.3</td> <th>Insert</th> <td>G Class</td> </tr> </table>	O.D. Tolerance	+0.1 -0.3	Insert	G Class			<p>WEB CATALOGUE</p>		
	O.D. Tolerance	+0.1 -0.3	Insert	G Class							
	PFC Type										
Available only on WEB CATALOGUE	φ50~φ80										
HIGH FEED-COPY MILLING	DIEMASTER 5G	<table border="1"> <tr> <th>O.D. Tolerance</th> <td>0.0 -0.5</td> <th>Insert</th> <td>H Class</td> </tr> </table>	O.D. Tolerance	0.0 -0.5	Insert	H Class					
	O.D. Tolerance	0.0 -0.5	Insert	H Class							
	XFG Type										
A302	φ52~φ66										
COPY MILLING	SUPER DIEMASTER	<table border="1"> <tr> <th>O.D. Tolerance</th> <td>0 -0.2</td> <th>Insert</th> <td>G.M Class</td> </tr> </table>	O.D. Tolerance	0 -0.2	Insert	G.M Class					
	O.D. Tolerance	0 -0.2	Insert	G.M Class							
	HDM Type										
A320	φ50~φ125 (φ160)										

Type	Item Code	Shape / Tool dia.	Cutting edge angle / Max.DOC	Applications							
COPY MILLING	EXTREME DIEMASTER	<table border="1"> <tr> <td>O.D. Tolerance</td> <td>0 -0.2</td> <td>Insert M Class</td> </tr> </table>  <p>φ50~φ63</p>	O.D. Tolerance	0 -0.2	Insert M Class	 <p>RE6.0</p>	   	<p>WEB CATALOGUE</p> 			
	O.D. Tolerance	0 -0.2	Insert M Class								
	EXTDM Type										
Available only on WEB CATALOGUE											
FOR HEAVY MACHINING	HEPTA MILL	<table border="1"> <tr> <td>O.D. Tolerance</td> <td>-0.025 -0.175</td> <td>Insert M Class</td> </tr> </table>   <p>φ50~φ200</p>	O.D. Tolerance	-0.025 -0.175	Insert M Class		    				
	O.D. Tolerance	-0.025 -0.175	Insert M Class								
	HEP Type										
A344											
GENERAL FACE MILLING	DIJET MILL 45	<table border="1"> <tr> <td>Tool dia.</td> <td>O.D. Tolerance</td> </tr> <tr> <td>≤ φ63</td> <td>±0.25</td> </tr> <tr> <td>≥ φ80</td> <td>±0.5</td> </tr> </table>   <p>φ50~φ200</p>	Tool dia.	O.D. Tolerance	≤ φ63	±0.25	≥ φ80	±0.5			<p>WEB CATALOGUE</p> 
	Tool dia.	O.D. Tolerance									
	≤ φ63	±0.25									
≥ φ80	±0.5										
SSE45 Type											
Available only on WEB CATALOGUE											
GENERAL SHOULDER MILLING	DIJET MILL 90	<table border="1"> <tr> <td>O.D. Tolerance</td> <td>±0.1</td> <td>Insert H.M Class</td> </tr> </table>  <p>φ50~φ160 (φ200)</p>	O.D. Tolerance	±0.1	Insert H.M Class		 	<p>WEB CATALOGUE</p> 			
	O.D. Tolerance	±0.1	Insert H.M Class								
	SSD90 Type										
Available only on WEB CATALOGUE											
For ALUMINIUM ALLOY	AERO CHIPPER	<table border="1"> <tr> <td>O.D. Tolerance</td> <td>0 -0.1</td> <td>Insert G Class</td> </tr> </table>   <p>φ50~φ63</p>	O.D. Tolerance	0 -0.1	Insert G Class	 <p>RE0.2~RE4.0</p>	    				
	O.D. Tolerance	0 -0.1	Insert G Class								
	ALX Type										
A355											

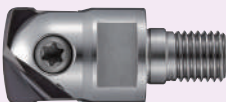
MILLING TOOLS QUICK GUIDE

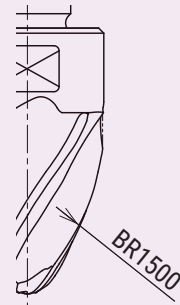
Type	Item Code	Shape / Tool dia.	Cutting edge angle / Max.DOC	Applications	
FINISHING SIDE & BOTTOM FACE	BACK DRAFT CUTTER	O.D. 0 Tolerance -0.1 Insert H Class 	 <p>Bottom Finishing</p>	 	WEB CATALOGUE 
	DBD Type	$\phi 50 \sim \phi 80$	 <p>Side Finishing</p>	 	
	Available only on WEB CATALOGUE				
ROUGHING • COPY MILLING	RADIUS MILL	O.D. -0.05 Tolerance -0.15 Insert M Class 		 	WEB CATALOGUE 
	WDR Type	$\phi 50 \sim \phi 125$		 	
	Available only on WEB CATALOGUE				
5 - AXIS	HIGH PRECISION QM MAX	O.D. 0 Tolerance -0.03 Insert H.M Class 		 	
	MQT Type	$\phi 16 \sim \phi 35$			
	A031				

Type	Item Code	Shape / Tool dia.	Barrel R	Applications	
5 - AXIS	FUJI BARREL			 	
	FJVA Type	$\phi 6 \sim \phi 12$			
	A030		BR250		

Type	Item Code	Shape / Tool dia.	Barrel R	Applications
5 - AXIS	MIRROR BARREL	O.D. Tolerance: -0.002 to -0.018 Insert F _{Class}		    
	KRM Type			
	A025	$\phi 16 \sim \phi 30$		
5 - AXIS	MIRROR BARREL	O.D. Tolerance: ± 0.008 Insert F _{Class}		  
	TNM Type			
	A026	$\phi 16 \sim \phi 20$		
5 - AXIS	MIRROR BARREL	O.D. Tolerance: ± 0.008 Insert F _{Class}		   
	TPM Type			
	A027	$\phi 16 \sim \phi 20$		
5 - AXIS	MIRROR BARREL	O.D. Tolerance: ± 0.008 Insert F _{Class}		    
	LRM Type			
	A028	$\phi 16 \sim \phi 30$		
5 - AXIS	S-HEAD			   
	STLP Type			
	A029			

DESIGNATION SYSTEM FOR MILLING INSERT



1 Shape

Symbol	Shape	Nose angle	Figure
H	Hexagonal	120°	
O	Octagonal	135°	
P	Pentagonal	108°	
S	Square	90°	
T	Triangular	60°	
C	Rhombic	80°	
D		55°	
E		75°	
M		86°	
V		35°	
L	Rectangular	90°	
A	Parallelogram	85°	
R	Round	—	
W	Special design	others	
X			
Y			
Z			

2 Relief angle

Symbol	Relief angle
B	5°
C	7°
D	15°
E	20°
F	25°
G	30°
N	0°
P	11°
O	others

3 Accuracy

Symbol	Corner height	Tolerance (mm)	
		Thickness	I.C. dia.
C	±0.013	±0.025	±0.025
E	±0.025	±0.025	±0.025
G	±0.025	±0.13	±0.025
H	±0.013	±0.025	±0.013
K	±0.013	±0.025	±0.05~±0.13
L	±0.025	±0.025	±0.05~±0.13
M	±0.08~±0.18	±0.13	±0.05~±0.13
N	±0.08~±0.18	±0.025	±0.05~±0.13
U	±0.13~±0.38	±0.13	±0.08~±0.25

Inscribed circle	Tolerance on I.C. dia. K, L, M (class)	Tolerance on corner height M (class)
6.35	±0.05	±0.08
9.525		
12.7	±0.08	±0.13
15.875	±0.1	±0.15
19.05		

4 Groove

Symbol	Shape	Symbol	Shape
N		U	
R		B	
F		H	
W		C	
T		J	
Q		X	others

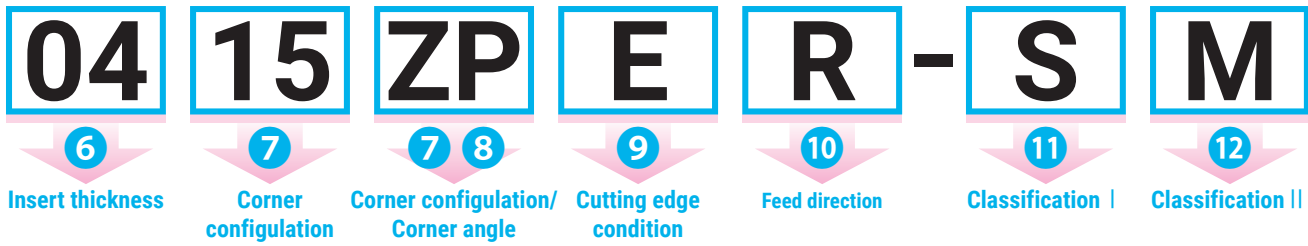

5 Cutting edge length

Symbol	length (ℓ)	Symbol	length (ℓ)
H		C M D V E	
O		L	
S		A	
T		R	

6 Thickness

Symbol	Thickness (mm)
02	2.38
T2	2.78
03	3.18
T3	3.97
04	4.76
05	5.56
06	6.35
07	7.94
09	9.52

7 Corner configuration

Symbol	Corner radius (mm)
02	0.2
04	0.4
08	0.8
12	1.2
15	1.5
16	1.6
20	2.0
25	2.5
30	3.0
32	3.2
40	4.0

8 Corner angle

Symbol	Clearance
D	15°
E	20°
F	25°
G	30°
P	11°



9 Symbols of major cutting edge

Symbol	Condition of cutting edge	Shape
F	Sharp edge	
E	Round honing	
T	Angle honing	
S	Combination Honing	

Symbol	Corner angle
A	45°
E	75°
P	90°
Z	others
MO	Round

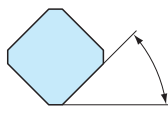

10 Feed direction

Symbol	Hand
R	Right
L	Left
N	Neutral

11 Classification I

Symbol	Work
P	Steel
M	Stainless Steel
K	Cast iron
N	Non ferrous material
S	Heat resistant alloy
H	Hardened material

12 Classification II

Symbol	Application
L	Light cutting
M	Medium cutting
H	Heavy cutting

HIGH FEED TOOLS LINE-UP

HIGH STRENGTH INSERT WITH SHARPNESS & STABILITY.
 RELIABLE EVEN AT HIGH FEED RATE & HIGH DEPTH OF CUT.
 DEVELOPED FOR HIGH METAL REMOVAL MACHINING.
 $ap \leq 3mm$



SKS SERIES

SKS SERIES

SKS EXTREME EXSKS 09 Type	SKS EXTREME EXSKS 07 Type	SKS GII SKG/MSG Type	SKS EXTREME EXSKS 05 Type
			
<ul style="list-style-type: none"> ● 6 cutting edges ● High metal removal ● Max.ap = 3mm ● Machine type: BT50 ● Program R : R3.5 	<ul style="list-style-type: none"> ● 6 cutting edges ● Excellent balance of stability & sharpness ● Max.ap = 2mm ● Machine type: BT50 ● Program R : R3.0 	<ul style="list-style-type: none"> ● 4 cutting edges ● For High feed & High D.O.C. machining ● Max.ap = 1.5-2.5mm ● Machine type: BT40-50 ● Program R : R2.0-R4.0 	<ul style="list-style-type: none"> ● 6 cutting edges ● For High feed machining with multi-flutes ● Max.ap = 1.5mm ● Machine type: BT40-50 ● Program R : R2.5

ADVANCED 3-D SHAPED CUTTING EDGE INSERT WITH LOW CUTTING FORCE GEOMETRY . MULTI-FLUTES SPEC. HOLDER . DEVELOPED FOR HIGH SPEED MACHINING EVEN ON SMALL SIZED MACHINE.

$ap \leq 1mm$

QM SERIES

Low cutting force

QM SERIES

**QM MAX GII
GMX/MXG Type**



- 4 cutting edges
- Machining wide variety of materials
- Max.ap = 1.0mm
- Machine type: BT40-50
- Program R : R1.5

**QM MAX
QXP/MXQ Type**



- 2 cutting edges
- Multiple insert choices for wide range of applications
- Max.ap = 1.0mm
- Machine type: BT40-50
- Program R : R1.5

**QM MILL
MPM/PME Type**



- 2 cutting edges
- For roughing to finishing
- low cutting force
- Max.ap = 0.4mm
- Machine type: BT30-40
- Program R : R1.0

● Range of Tool Dia.

Product	No. of corners	Insert spec.	MAX. ap (mm)	Tool Dia. (mm)													
				10	16	20	25	32	40	50	52	63	66	80	100	125	160
QM MIL	2	Single sided	0.4	←→													
QM MAX	2	Single sided	1		←→												
QM MAX GII	4	Double sided	1		←→												
EXSKS-05	6	Double sided	1.5		←→												
SKSGII	4	Single sided	1.5 - 2.5		←→												
EXSKS-07	6	Double sided	2		←→												
EXSKS-09	6	Double sided	3			←→											

SHOULDER MILLING TOOLS LINE-UP

■ Shoulder Milling Series

SIC-EVO
QM MILL (ZOMT06 insert)
QM MAX (ZPMT10 insert)



- Single-sided 2 cutting edge insert
- Excellent chips control design
- Reliable even for long overhang machining

SHOULDER EXTREME
EXSAP-11 type
EXSAP-17 type



- Double-sided 4 cutting edge insert
- G class ground insert gives good surface finish on bottom & side wall

SHOULDER 6
EXSIX type



- Double-sided 6 cutting edge insert
- High cutting edge strength
- For heavy roughing process

■ Range of Tool Dia.

Product	No. of corners	Insert spec.	MAX. ap (mm)	Tool Dia. (mm)														
				10	16	20	25	32	40	50	52	63	66	80	100	125	160	
QM MIL	2	Single sided	5	← φ10~φ32 →														
QM MAX	2	Single sided	9		← φ16~φ66 →													
SIC-EVO	2	Single sided	15			← φ25~φ125 →												
EXSAP-11	4	Single sided	10		← φ16~φ80 →													
EXSAP-17	4	Single sided	15			← φ25~φ125 →												
EXSIX	6	Single sided	10						← φ50~φ160 →									

■ Selection Guide

Product	Cutting Force	Chip Control	Surface Finish	Wall Accuracy	Cutting Edge Strength	No. of Cutting Edges
SIC-EVO QM MILL (ZOMT06) QM MAX (ZPMT10)	★★★★	★★★★	★★★	★★★	★	★
EXSAP11 EXSAP17	★★★	★★★	★★★★★	★★★★★	★★★	★★★
EXSIX	★★★	★★★	★	★★★	★★★★★	★★★★★

Modular Head Series

■ PROPER MOUNTING OF MODULAR HEADS

1 Cleaning



Remove dirt and chips with air from the connecting thread and face of modular head and MSN/MGN shank holder.

2 Initial Tightening



Tighten by hand until the head and the shank holder faces touch.

3 Final Tightening



Tighten slowly with torque control spanner wrench or DIJET DS type spanner wrench and confirm that there is no gap.

- Attention)
1. Final tightening without initial tightening cause connecting thread damage.
 2. Only use DS type spanner wrench when use Solid modular head (SMSA/SMSR/SMAL type)

Attention

1. Only use torque control spanner wrench or DIJET DS type spanner wrench.
In case of choosing torque control spanner wrench, confirm that the wrench size is matched to the dimensions W & C of each modular head.



Torque control spanner



Spanner wrench (DS type)

2. Only apply gentle pressure on wrench.
3. Confirm there is no gap between MSN/MGN shank holder and modular head

■ Steel modular heads

Thread	Tightening torque	Spanner size(W)
M6	8.0N·m	8 [☆] 10
M8	16N·m	12 [☆]
M10	16N·m	14, 15
M12	20N·m	17, 19
M16	25N·m	22, 26

■ Solid modular heads(SMSA/SMSR/SMAL)

Thread	Tightening torque	Spanner size(W)	Cat.No.
M8	10~11N·m	14	DS-14
M10	10~11N·m	14	DS-14
M10	10~16N·m	17	DS-17
M12	15~20N·m	19, 22	DS-19, DS-22
M16	20~25N·m	27	DS-27

Note) Modular heads are supplied without spanner wrench

Modular Head Series

SELECTION OF MSN CARBIDE SHANK HOLDER

When using modular head over $\varnothing 16\text{mm}$, please select MSN carbide shank which the diameter ($\varnothing D1$) is 1 mm or smaller than modular head ($\varnothing Dc$).

Wrong selection can cause damage to the carbide shank.

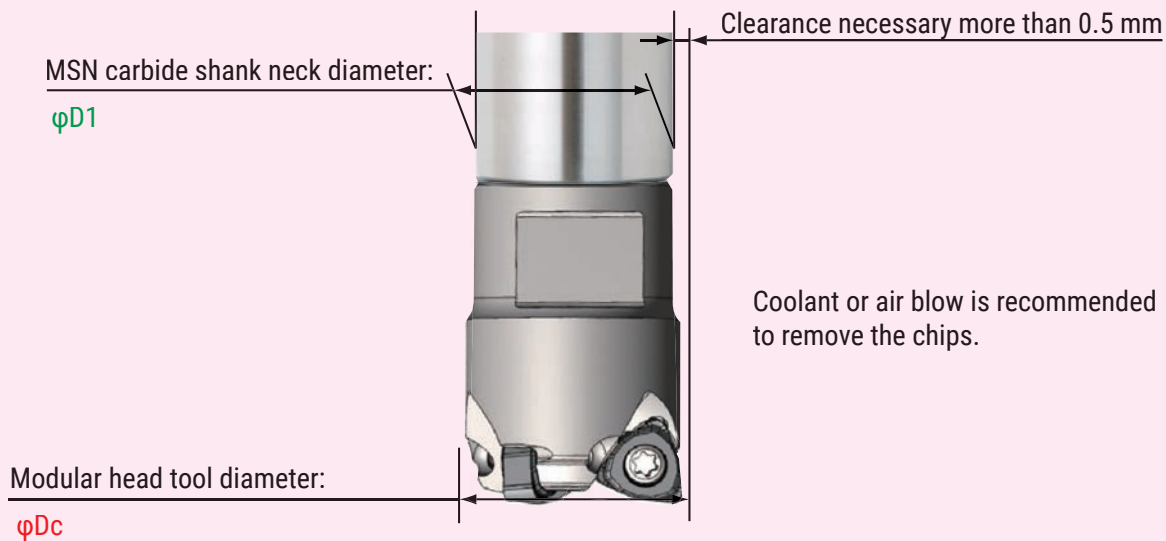

⚠ Caution for mounting in shrink fit holder.

When you use a carbide shank and a modular head on a shrink fit holder, please shrink fit only the carbide shank without mounting the modular head. Mount the modular head on the shank after shrink fit operation is complete. In case of shrink fit MSN shank + modular head together, it will be difficult to loosen due to heat

5-AXIS Series

TECHNOLOGY

Designs that allow you to machine freely & quickly



Advanced machining technology that enables high-precision and high efficiency

A line-up that supports machining of complex shapes found in the Die&Mould and Aerospace industries.

5-AXIS Series

KRM
TYPE

Insert for "MIRROR BARREL" KRM type

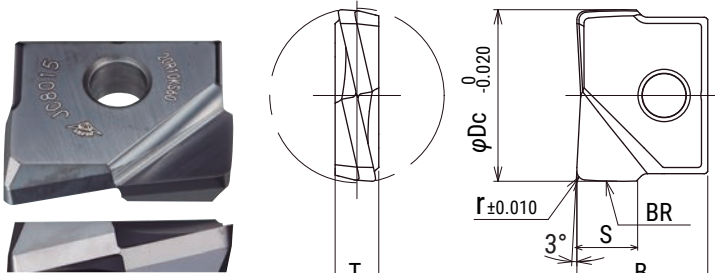

Radius form accuracy on the outer periphery $\pm 0.010\text{mm}$

Corner radius accuracy of inserts within $\pm 0.010\text{mm}$

5
axis

Cat.No.	Grade		Dimensions (mm)					
	JC8015	DH102	ϕDc	r	BR	S	B	T
KRM-160-R10-BR50	●	●	16	1	50	5.7	12	4
KRM-200-R10-BR60	●	●	20	1	60	6.8	15	5
KRM-250-R10-BR60	●	●	25	1	60	7.3	18.5	6
KRM-300-R10-BR60	●	●	30	1	60	9.1	22.5	7

MRX
TYPE



Modular head MRX type

Accuracy of MRX after combined O.D. run out: below 15 μm (Target below 10 μm).
When using KRM type insert/Corner radius accuracy: within $\pm 0.010\text{mm}$. Radius form accuracy on the outer periphery: within $\pm 0.010\text{mm}$.

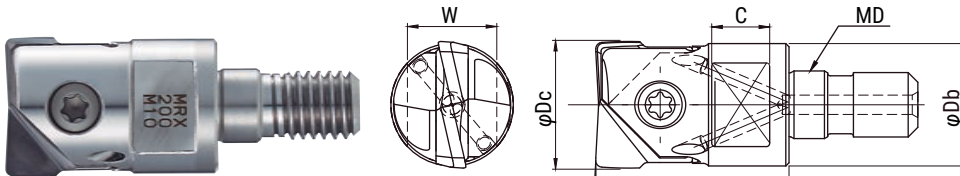
5
axis



Clamp screw	Torque(N·m)
FSW-4013H	3.0
FSW-5016H	4.0
FSW-6020	5.0
FSW-8025S	6.0

Cat.No.	Stock	Dimensions (mm)						Inserts		Parts	
		ϕDc	Lf	ϕDb	MD	C	W				
MRX-160-M8	●	16	23	15	M8	8	12	RNM-160/170... FRM-160/170...	/HRM-160/170... /KRM-160...	FSW-4013H	A-15
MRX-200-M10	●	20	30	19	M10	8	14	RNM-200/210... FRM-200/210...	/HRM-200/220... /KRM-200...	FSW-5016H	A-20W
MRX-250-M12	●	25	25	24	M12	10	17	RNM-250/260...	/FRM-250... /KRM-250...	FSW-6020	A-30
MRX-300-M16	●	30	30	29	M16	12.5	22	RNM-300...	/FRM-200/220... /KRM-300...	FSW-8025S	A-30

5-AXIS Series



Insert for "MIRROR BARREL" TNM type

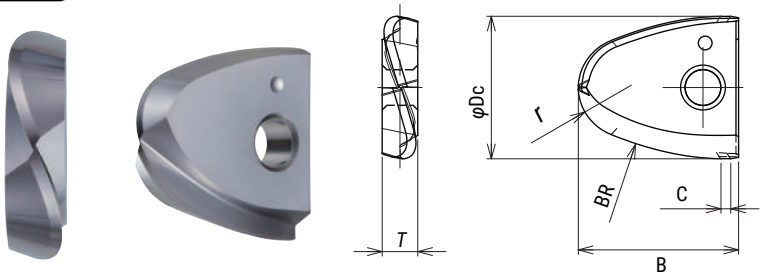

Corner radius accuracy of inserts within $\pm 0.010\text{mm}$



Cat.No.	Grade		Dimensions (mm)					
	JC8015	FZ15	ϕDc	r	BR	B	T	C
TNM-160-NR6BR32	●		16	6	32	4	1	4
TNM-160-NR6BR32		●	16	6	32	4	1	5
TNM-200-NR8BR40	●		20	8	40	5	1	6
TNM-200-NR8BR40		●	20	8	40	5	1	7



MIRROR BARREL Modular head MTP type

Through coolant hole

Accuracy of MTP after combined O.D. run out: below 15 μm (Target below 10 μm).
When using TNM type insert / Radius form accuracy on the outer periphery: within $\pm 0.010\text{mm}$.

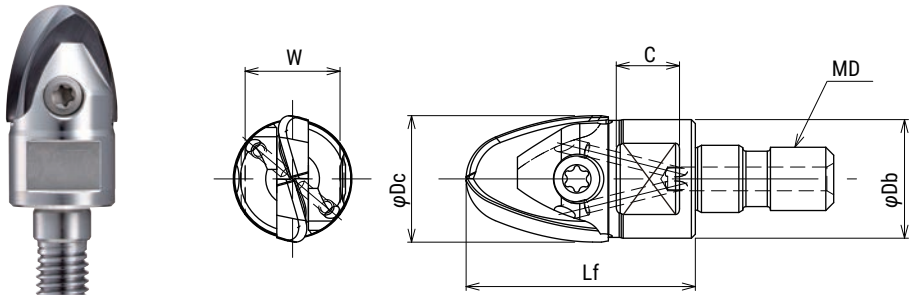

Clamp screw	Torque(N·m)
FSW-4013H	3.0
FSW-5016H	4.0

Cat.No.	Stock	Dimensions (mm)						Inserts	Parts	
		ϕDc	Lf	ϕDb	MD	C	W		Screw	Wrench
MTP-160-M8	●	16	29	15	M8	8	12	TPM-160... TNM-160...	FSW-4013H	A-15
MTP-200-M10	●	20	36	19	M10	8	14	TPM-200... TNM-200...	FSW-5016H	A-20W

5-AXIS Series

TPM
TYPE

Insert for "MIRROR BARREL" TPM type

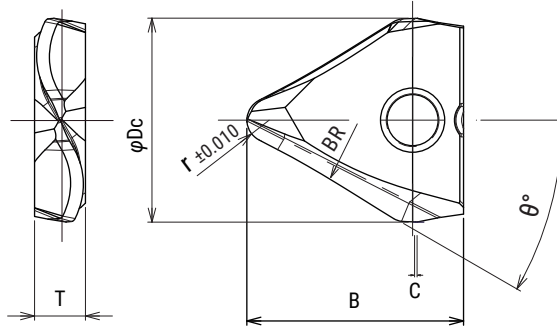
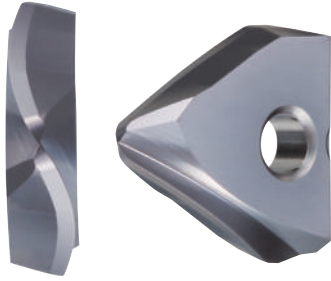

Radius form accuracy on the outer periphery $\pm 0.010\text{mm}$

5
axis

Radius accuracy of inserts within $\pm 0.010\text{mm}$

Cat.No.	Grade		Dimensions (mm)						
	JC8015	DH102	ϕDc	r	BR	B	T	C	θ°
TPM-160-NR2T30BR400	●	●	16	2	400	17	4	1	30°
TPM-200-NR2T30BR500	●	●	20	2	500	20	5	1	30°

MTP
TYPE

MIRROR BARREL Modular head MTP type

Through coolant hole

Accuracy of MTP after combined O.D. run out: below 15 μm (Target below 10 μm).

When using TPM type insert / Corner Radius accuracy: within $\pm 0.010\text{mm}$. Radius form accuracy on the outer periphery: within $\pm 0.010\text{mm}$.

5
axis

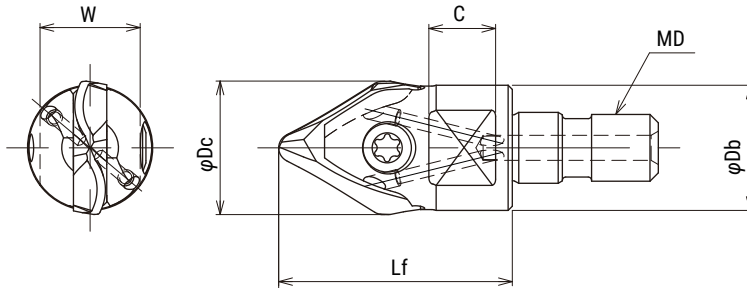

Clamp screw	Torque(N·m)
FSW-4013H	3.0
FSW-5016H	4.0

Cat.No.	Stock	Dimensions (mm)						Inserts	Parts	
		ϕDc	Lf	ϕDb	MD	C	W		Screw	Wrench
MTP-160-M8	●	16	28	15	M8	8	12	TPM-160... TNM-160...	FSW-4013H	A-15
MTP-200-M10	●	20	35	19	M10	9	14	TPM-200... TNM-200...	FSW-5016H	A-20W

5-AXIS Series

LRM
TYPE

Insert for "MIRROR BARREL" LRM type

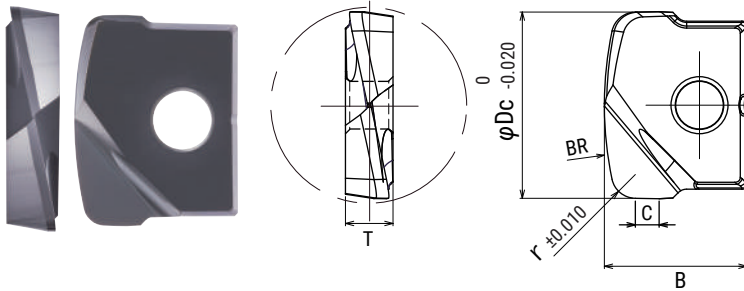

Radius form accuracy on the bottom $\pm 0.010\text{mm}$

5
axis

Corner radius accuracy of inserts within $\pm 0.010\text{mm}$

Cat.No.	Grade		Dimensions (mm)					
	JC8015	FZ15	ϕDc	r	BR	B	T	C
LRM-160-R20-BR32	●	●	16	2	32	12	4	2
LRM-200-R30-BR40	●	●	20	3	40	15	5	2
LRM-250-R30-BR50	●	●	25	3	50	18.50	6	2.5
LRM-300-R30-BR60	●	●	30	3	60	22.50	7	3

MBX
TYPE

Modular head MBX type

Through coolant hole

Accuracy of MBX after combined O.D. run out: below $15\mu\text{m}$ (Target below $10\mu\text{m}$).

When using LRM type insert/Corner radius accuracy: within $\pm 0.010\text{mm}$. Radius form accuracy on the front edge: within $\pm 0.010\text{mm}$.

5
axis

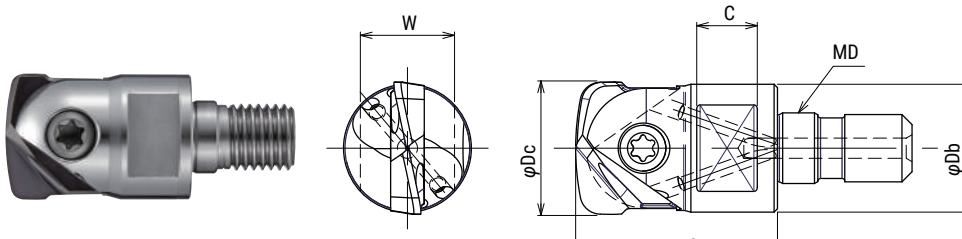

Clamp screw	Torque(N.m)
FSW-4013H	3.0
FSW-5016H	4.0
FSW-6020	5.0
FSW-8025S	6.0

Cat.No.	Stock	Dimensions (mm)						Inserts		Parts	
		ϕDc	Lf	ϕDb	MD	C	W			Screw	Wrench
MBX-160-M8	●	16	23	15	M8	8	12	BNM-160...	/LRM-160...	FSW-4013H	A-15
MBX-200-M10	●	20	30	19	M10	8	14	BNM-200...	/LRM-200...	FSW-5016H	A-20W
MBX-250-M12	●	25	35	24	M12	10	17	BNM-250...	/LRM-250...	FSW-6020	A-30
MBX-300-M16	●	30	43	29	M16	12.5	22	BNM-300...	/LRM-300...	FSW-8025S	A-30

5-AXIS Series

STLP
TYPE

Solid modular head STLP type

- 4flutes Helix angle 30°

Radius form accuracy
on the outer periphery
±0.010mm

DH
Coating

5
axis

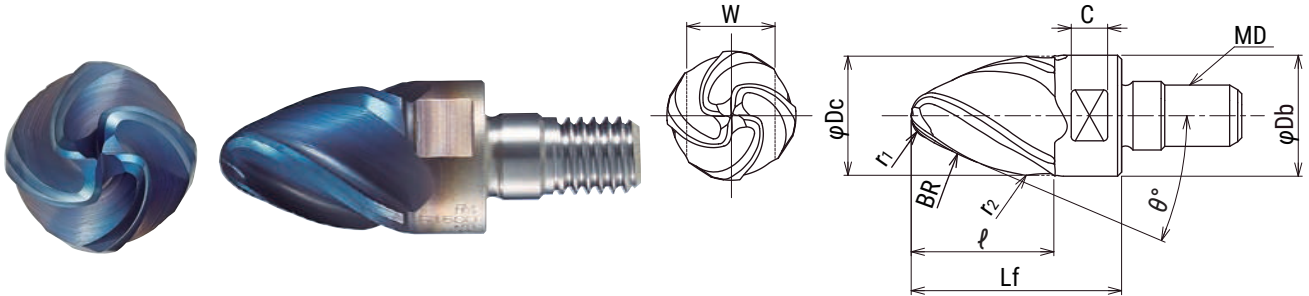

Cat.No.	Stock	Grade	No. of Flutes	Dimensions (mm)										
				φDc	ℓ	Lf	BR	r ₁	r ₂	θ°	φDb	MD	C	W
STLP-4160T20R4-M8	●	DH115	4	16	17.7	26	1500	4	4	20°	15	M8	5.5	14
STLP-4200T15R4-M10	●			20	30	38	1500	4	5	15°	19	M10	5.5	17
STLP-4200T20R5-M10	●			20	22	30	1500	5	5	20°	19	M10	5.5	17
STLP-4250T20R5-M12	●			25	28	38	2,200	5	5	20°	24	M12	5.5	22

φDc (mm)	Torque	Width across flats W (mm)	DIJET DS type spanner
φ16	10~11 N·m	14	DS-14
φ20	10~16 N·m	17	DS-17

5-AXIS Series

FJVA
TYPE

“FUJI BARRELL” FJVA type

Radius form accuracy
on the outer periphery
 $\pm 0.010\text{mm}$

DH
Coating

5
axis

- 4flutes
- For shrink fit holder

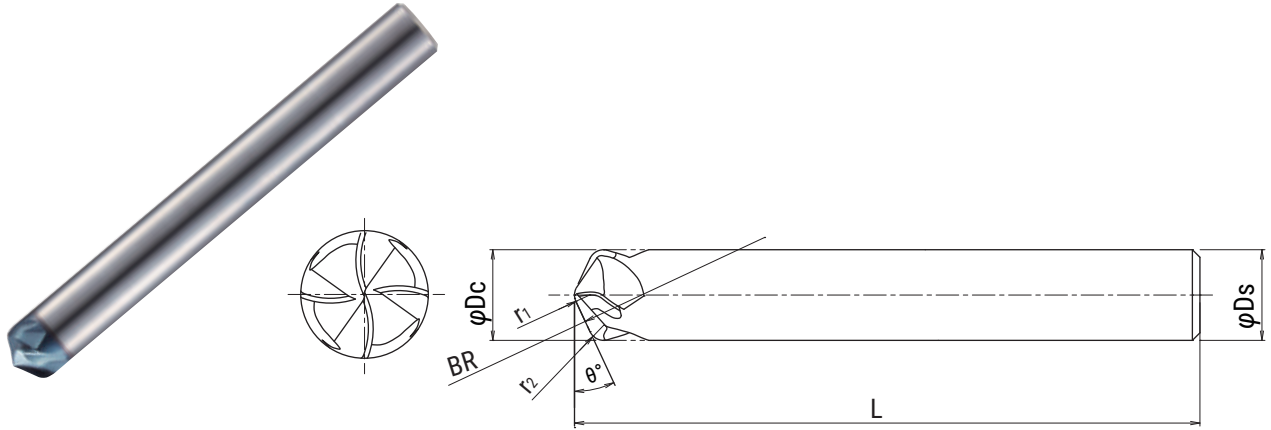

Cat.No.	Stock	Grade	No.of Flutes	Dimensions (mm)						
				ϕDc	BR	r_1	r_2	θ°	L	ϕDs
FJVA4060S06-R250	●	DH115	4	6	250	1	1	25°	60	6
FJVA4080S08-R250	●			8	250	1	1.2	25°	75	8
FJVA4100S10-R250	●			10	250	1	1.75	25°	80	10
FJVA4120S12-R250	●			12	250	1	1.75	25°	100	12

5-AXIS Series



High precision "QM MAX" MQT type

- 3 different angled bodies (0°, 3°, and 5°) that cover a range of tapered walls from 0° ~ 8°
- Possible to use even on 3 axis machine with 3° or 5° angled body ; A03 type or A05 type
- High tolerance insert-pocket for the ground inserts
- High efficiency with multi flutes

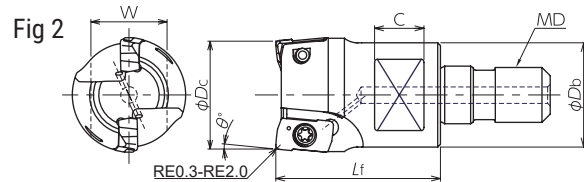
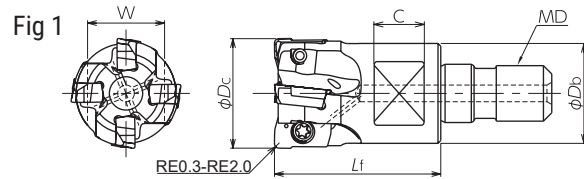

Inclination angle θ°	Cat.No.	Stock	No. of inserts	Dimensions (mm)						Parts		Inserts	Fig.
				φD_c	L_f	φD_b	MD	C	W	Screws	Wrench		
0°	MQT-2016A00-M8	●	2	16	23	14	M8	8	12	TSW-2556H	A-08	XP**100308ZER-R; YPHW1003**Z*R-**; ZPMT1003**ZER-PL	1
	MQT-4020A00-M10	●	4	20	30	18	M10	9	14				
	MQT-5025A00-M12	●	5	25	35	22.5	M12	10	17	DSW-2563H			
	MQT-6032A00-M16	●	6	32	43	29	M16	12	22				
MQT-6035A00-M16	●	35		M16									
3°	MQT-2016A03-M8	●	2	16	23	14	M8	8	12	TSW-2556H			2
	MQT-2020A03-M10	●		20	30	18	M10	9	14				
5°	MQT-2016A05-M8	●		16	23	14	M8	8	12		TSW-2556H		
	MQT-2020A05-M10	●		20	30	18	M10	9	14				

Clamp screw	Torque(N.m)
TSW-2556H	3.0
DSW-2563H	4.0

5-AXIS Series

For tapered wall finishing
 (XPHW100308ZER-R)
 (XPHT100308RZER-R)

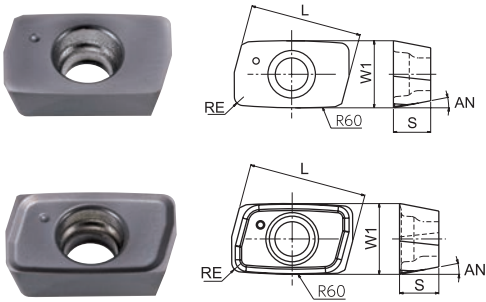

For finishing side face
 (YPHW1003**ZER-15)
 (YPHW100308ZER-F)
 (YPHW100308ZTR-F1)

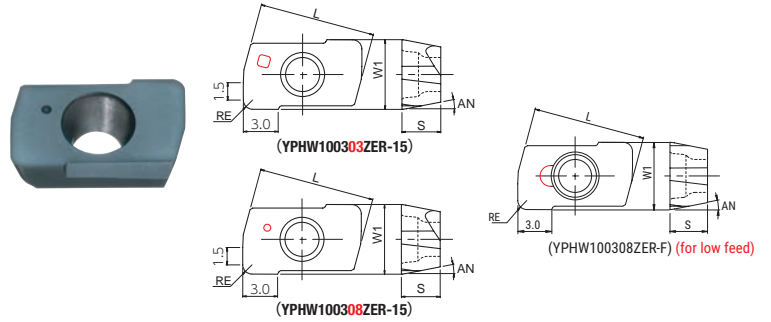

Shoulder milling insert
 (from semi-finishing to finishing)
 ZPMT1003**ZER-PL*

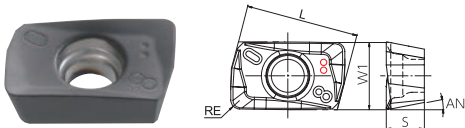

CBN Insert

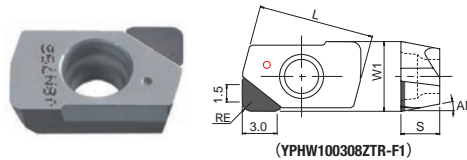

Type	Cat.No.	Tolerance	PVD Coating				Cermet	CBN	Dimensions (mm)			
			DH102	JC8015	JC8050	JC8118	CX75	JBN795	RE	L	W1	S
For tapered wall finishing	XPHW100308ZER-R	H	●	●			●	0.8	10.06	6	3.35	11°
	XPHT100308ZER-R			●			●					
For finishing side face	YPHW100303ZER-15	H	●	●			●	0.3	10.06	6	3.35	11°
	YPHW100308ZER-15		●			●						
	YPHW100308ZER-F			●		●	0.8					
	YPHW100308ZTR-F1					●						
Shoulder milling insert (from semi-finishing to finishing)	ZPMT100304ZER-PL	M	●		●	●		0.4	10.08	3.4		
	ZPMT100308ZER-PL		●		●	●	0.8					
	ZPMT100320ZER-PL		●		●	●						2

5-AXIS Series

■ Recommended cutting conditions



● KRM Type Side finishing

Material	Grade	Tool dia.(mm)							
		16				20			
		ap (mm)	ae (mm)	n (min ⁻¹)	Vf (mm/min)	ap (mm)	ae (mm)	n (min ⁻¹)	Vf (mm/min)
Carbon steel (S50C, S55C) below 250HB	JC8015	0.8	0.15	5,970	2,390	1	0.15	4,770	1,910
Cast steel (GM190, ICD5) below 285HB	JC8015	0.8	0.15	5,970	2,390	1	0.15	4,770	1,910
Tool & die steel (SKD61, SKD11) below 255HB	JC8015	0.8	0.15	5,970	2,390	1	0.15	4,770	1,910
Mold steel (HPM7, PX5, P20) 30-36 HRC	JC8015	0.8	0.12	5,970	2,390	1	0.12	4,770	1,910
Mold steel (NAK80, HPM1, P21) 38-43HRC	JC8015	0.8	0.12	5,570	1,670	1	0.12	4,460	1,340
Hardened die steel (SKD61, DAC, DHA) 42-52HRC	DH102	0.6	0.1	4,970	750	0.7	0.1	3,980	600
Hardened die steel (SKD11, SL, DC11) 55-62HRC	DH102	0.5	0.1	3,980	600	0.7	0.1	3,180	480
Grey cast iron (FC250) 160-260HB	DH102	0.8	0.2	6,960	3,480	1	0.2	5,570	3,340
Nodular cast iron (FCD700) 170-300HB	DH102	0.8	0.2	6,960	3,480	1	0.2	5,570	3,340
Austenitic stainless steel (SUS304, 316, 317) 17Cr	JC8015	0.8	0.12	5,570	2,230	1	0.12	4,460	1,780
Ferritic & martensitic stainless steel (SUS403, 420J2, 430) 13Cr	JC8015	0.8	0.12	5,570	2,230	1	0.12	4,460	1,780
Titanium alloy (Ti-6Al-4V) 35-43HRC	JC8015	0.5	0.1	1,990	480	0.6	0.1	1,590	380
Heat resistant alloy (INCO718) 35-43HRC	JC8015	0.5	0.1	1,590	380	0.6	0.1	1,270	300

Please refer to chart and formula below to calculate ap.

H(Cusp Height)

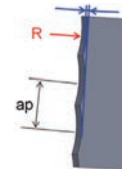

$$a_p = 2 \sqrt{R^2 - (R - H)^2}$$

ap(mm)		Cusp height (mm)									
Cat.No.	R	0.001	0.002	0.003	0.004	0.005	0.006	0.007	0.008	0.009	0.010
KRM-160-R10-BR50	50	0.63	0.89	1.10	1.26	1.41	1.55	1.67	1.79	1.90	2.00
KRM-200-R10-BR60	60	0.69	0.98	1.20	1.39	1.55	1.70	1.83	1.96	2.08	2.19

Note

1. Please adjust cutting conditions according to machine rigidity or work rigidity.
2. These parameters are for overhang length 3Dc. See right table for longer application.
3. In case of chatter occurring, recommended to reduce ap or rpm and keep feed per tooth.
4. Use air blow.

Overhang (l / Dc)	n (min ⁻¹)	Vf (mm/min)
~ 3Dc	100%	100%
3Dc ~ 5Dc	70%	70%
5Dc ~ 10Dc	50%	50%

5-AXIS Series

■ Recommended cutting conditions



● KRM Type Side finishing

Material	Grade	Tool dia.(mm)							
		25				30			
		ap (mm)	ae (mm)	n (min ⁻¹)	Vf (mm/min)	ap (mm)	ae (mm)	n (min ⁻¹)	Vf (mm/min)
Carbon steel (S50C, S55C) below 250HB	JC8015	1.2	0.15	3,820	1,530	1.2	0.15	3,180	1,270
Cast steel (GM190, ICD5) below 285HB	JC8015	1.2	0.15	3,820	1,530	1.2	0.15	3,180	1,270
Tool & die steel (SKD61, SKD11) below 255HB	JC8015	1.2	0.15	3,820	1,530	1.2	0.15	3,180	1,270
Mold steel (HPM7, PX5, P20) 30-36 HRC	JC8015	1.2	0.12	3,820	1,530	1.2	0.12	3,180	1,270
Mold steel (NAK80, HPM1, P21) 38-43HRC	JC8015	1	0.12	3,570	1,070	1	0.12	2,970	890
Hardened die steel (SKD61, DAC, DHA) 42-52HRC	DH102	0.8	0.1	3,180	480	0.8	0.1	2,650	400
Hardened die steel (SKD11, SLD, DC11) 55-62HRC	DH102	0.7	0.1	2,550	380	0.7	0.1	2,120	320
Grey cast iron (FC250) 160-260HB	DH102	1.2	0.2	4,460	2,680	1.2	0.2	3,710	2,230
Nodular cast iron (FCD700) 170-300HB	DH102	1.2	0.2	4,460	2,680	1.2	0.2	3,710	2,230
Austenitic stainless steel (SUS304, 316, 317) 17Cr	JC8015	1.2	0.12	3,570	1,430	1.2	0.12	2,970	1,190
Ferritic & martensitic stainless steel (SUS403, 420J2, 430) 13Cr	JC8015	1.2	0.12	3,570	1,430	1.2	0.12	2,970	1,190
Titanium alloy (Ti-6Al-4V) 35-43HRC	JC8015	0.7	0.1	1,270	320	0.7	0.1	1,060	270
Heat resistant alloy (INCO718) 35-43HRC	JC8015	0.7	0.1	1,020	260	0.7	0.1	850	210

Please refer to chart and formula below to calculate ap.

$$a_p = 2 \sqrt{(R^2 - (R - H)^2)}$$

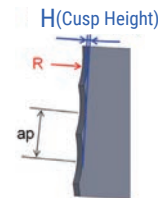

ap(mm)		Cusp height (mm)									
Cat.No.	R	0.001	0.002	0.003	0.004	0.005	0.006	0.007	0.008	0.009	0.010
KRM-250-R10-BR60	60	0.69	0.98	1.20	1.39	1.55	1.70	1.83	1.96	2.08	2.19
KRM-300-R10-BR60											

Note

1. Please adjust cutting conditions according to machine rigidity or work rigidity.
2. These parameters are for overhang length 3Dc. See right table for longer application.
3. In case of chatter occurring, recommended to reduce ap or rpm and keep feed per tooth.
4. Use air blow.

Overhang (l/Dc)	n (min ⁻¹)	Vf (mm/min)
~ 3Dc	100%	100%
3Dc ~ 5Dc	70%	70%
5Dc ~ 10Dc	50%	50%

5-AXIS Series

■ Recommended cutting conditions



● TNM Type Side finishing with Barrel R

Material	Grade	Tool dia.(mm)							
		16				20			
		a_p (mm)	a_e (mm)	n (min ⁻¹)	V_f (mm/min)	a_p (mm)	a_e (mm)	n (min ⁻¹)	V_f (mm/min)
Carbon steel (S50C, S55C) below 250HB	JC8015	~1	0.2	6,960	2,780	~1	0.2	5,570	2,230
Cast steel (GM190, ICD5) below 285HB	JC8015	~1	0.2	6,960	2,780	~1	0.2	5,570	2,230
Tool & die steel (SKD61, SKD11) below 255HB	JC8015	~1	0.2	6,960	2,780	~1	0.2	5,570	2,230
Mold steel (HPM7, PX5, P20) 30-36 HRC	JC8015	~1	0.2	6,960	2,780	~1	0.2	5,570	2,230
Mold steel (NAK80, HPM1, P21) 38-43HRC	JC8015	~1	0.2	5,970	2,390	~1	0.2	4,770	1,910
Hardened die steel (SKD61, DAC, DHA) 42-52HRC	JC8015	~1	0.1	4,970	1,490	~1	0.1	3,980	1,190
Grey cast iron (FC250) 160-260HB	JC8015	~1	0.2	6,960	2,780	~1	0.2	5,570	2,230
Nodular cast iron (FCD700) 170-300HB	JC8015	~1	0.2	6,960	2,780	~1	0.2	5,570	2,230
Austenitic stainless steel (SUS304, 316, 317) 17Cr	JC8015	~1	0.2	6,960	2,090	~1	0.2	5,570	1,670
Ferritic & martensitic stainless steel (SUS403, 420J2, 430) 13Cr	JC8015	~1	0.2	6,960	2,090	~1	0.2	5,570	1,670
Titanium alloy (Ti-6Al-4V) 35-43HRC	JC8015	~0.4	0.15	4,970	1,490	~0.4	0.15	3,980	1,190
Heat resistant alloy (INCO718) 35-43HRC	JC8015	~0.4	0.1	3,980	800	~0.4	0.1	3,180	640
Aluminium alloy below 50-110HRC	FZ15	~1.5	0.25	9,950	4,980	~1.5	0.25	7,960	4,780

Please refer to chart and formula below to calculate a_p .

$$a_p = 2 \sqrt{(R^2 - (R - H)^2)}$$

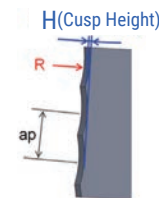

a_p (mm)		Cusp height (mm)									
Cat.No.	R	0.001	0.002	0.003	0.004	0.005	0.006	0.007	0.008	0.009	0.010
TNM-160-NR6BR32	32	0.51	0.72	0.88	1.01	1.13	1.24	1.34	1.43	1.52	1.60
TNM-200-NR8BR40	40	0.57	0.80	0.98	1.13	1.26	1.39	1.50	1.60	1.70	1.79

Note

1. Please adjust cutting conditions according to machine rigidity or work rigidity.
2. These parameters are for overhang length 3Dc. See right table for longer application.
3. In case of chatter occurring, recommended to reduce a_p or rpm and keep feed per tooth.
4. Use air blow.

Overhang (l/Dc)	n (min ⁻¹)	V_f (mm/min)
~ 3Dc	100%	100%
3Dc ~ 5Dc	70%	70%
5Dc ~ 10Dc	50%	50%

5-AXIS Series

■ Recommended cutting conditions



● TNM Type - with Tip R

Material	Grade	Tool dia.(mm)							
		16				20			
		a_p (mm)	a_e (mm)	n (min^{-1})	V_f (mm/min)	a_p (mm)	a_e (mm)	n (min^{-1})	V_f (mm/min)
Carbon steel (S50C, S55C) below 250HB	JC8015	0.15	0.2	10,940	4,380	0.15	0.25	8,750	5,250
Cast steel (GM190, ICD5) below 285HB	JC8015	0.15	0.2	10,940	4,380	0.15	0.25	8,750	5,250
Tool & die steel (SKD61, SKD11) below 255HB	JC8015	0.15	0.2	10,940	4,380	0.15	0.25	8,750	5,250
Mold steel (HPM7, PX5, P20) 30-36 HRC	JC8015	0.15	0.2	9,950	3,980	0.15	0.25	7,960	4,780
Mold steel (NAK80, HPM1, P21) 38-43HRC	JC8015	0.1	0.2	7,960	2,390	0.1	0.25	6,370	3,190
Hardened die steel (SKD61, DAC, DHA) 42-52HRC	JC8015	0.1	0.2	5,970	1,790	0.1	0.25	4,770	2,390
Grey cast iron (FC250) 160-260HB	JC8015	0.15	0.2	10,940	5,470	0.15	0.25	8,750	6,130
Nodular cast iron (FCD700) 170-300HB	JC8015	0.15	0.2	10,940	5,470	0.15	0.25	8,750	6,130
Austenitic stainless steel (SUS304, 316, 317) 17Cr	JC8015	0.15	0.2	10,940	4,380	0.15	0.25	8,750	5,250
Ferritic & martensitic stainless steel (SUS403, 420J2, 430) 13Cr	JC8015	0.15	0.2	10,940	4,380	0.15	0.25	8,750	5,250
Titanium alloy (Ti-6Al-4V) 35-43HRC	JC8015	0.1	0.2	7,960	3,180	0.1	0.25	6,370	3,190
Heat resistant alloy (INCO718) 35-43HRC	JC8015	0.1	0.1	5,970	1,790	0.1	0.1	4,770	1,910
Aluminium alloy below 50-110HRC	FZ15	0.25	0.2	13,330	6,670	0.25	0.2	10,660	6,400

Note

1. Please adjust cutting conditions according to machine rigidity or work rigidity.
2. These parameters are for overhang length 3Dc. See right table for longer application.
3. In case of chatter occurring, recommended to reduce a_p or rpm and keep feed per tooth.
4. Use air blow.

Overhang (l/Dc)	n (min^{-1})	V_f (mm/min)
$\sim 3Dc$	100%	100%
$3Dc \sim 5Dc$	70%	70%
$5Dc \sim 10Dc$	50%	50%

5-AXIS Series

■ Recommended cutting conditions



● TPM Type - with Barrel R

Material	Grade	Tool dia.(mm)							
		16				20			
		a_p (mm)	a_e (mm)	n (min ⁻¹)	V_f (mm/min)	a_p (mm)	a_e (mm)	n (min ⁻¹)	V_f (mm/min)
Carbon steel (S50C, S55C) below 250HB	JC8015	~4	0.15	13,930	4,180	~5	0.2	11,140	3,340
Cast steel (GM190, ICD5) below 285HB	JC8015	~4	0.15	13,930	4,180	~5	0.2	11,140	3,340
Tool & die steel (SKD61, SKD11) below 255HB	JC8015	~4	0.15	13,930	4,180	~5	0.2	11,140	3,340
Mold steel (HPM7, PX5, P20) 30-36 HRC	JC8015	~3.5	0.12	11,940	3,580	~4.5	0.1	9,550	2,870
Mold steel (NAK80, HPM1, P21) 38-43HRC	JC8015	~3	0.12	9,950	2,990	~4	0.1	7,960	2,390
Hardened die steel (SKD61, DAC, DHA) 42-52HRC	DH102	~2.5	0.1	6,960	1,390	~3	0.1	5,570	1,110
Hardened die steel (SKD11, SLD, DC11) 55-62HRC	DH102	~2	0.1	5,970	1,190	~2.5	0.1	4,770	950
Grey cast iron (FC250) 160-260HB	DH102	~4	0.15	13,930	5,570	~5	0.2	11,140	4,460
Nodular cast iron (FCD700) 170-300HB	DH102	~4	0.15	13,930	4,180	~5	0.2	11,140	3,340
Austenitic stainless steel (SUS304, 316, 317) 17Cr	JC8015	~3	0.12	11,940	3,580	~4	0.1	9,550	2,870
Ferritic & martensitic stainless steel (SUS403, 420J2, 430) 13Cr	JC8015	~3	0.12	11,940	3,580	~4	0.1	9,550	2,870
Titanium alloy (Ti-6Al-4V) 35-43HRC	JC8015	~2.5	0.1	5,970	1,190	~3	0.1	4,770	950
Heat resistant alloy (INCO718) 35-43HRC	JC8015	~2.5	0.1	3,980	800	~3	0.1	3,180	640

Please refer to chart and formula below to calculate a_p .

$$a_p = 2 \sqrt{(R^2 - (R - H)^2)}$$

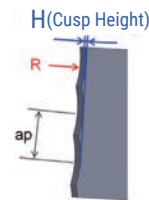

Pick amount a_p (mm)		Cusp height (mm)									
Cat.No.	R	0.001	0.002	0.003	0.004	0.005	0.006	0.007	0.008	0.009	0.010
TPM-160-NR2T30BR400	400	1.79	2.53	3.10	3.58	4.00	4.38	4.73	5.06	5.73	5.66
TPM-200-NR2T30BR500	500	2.00	2.83	3.46	4.00	4.47	1.39	4.90	5.66	6.00	6.32

Note

1. Please adjust cutting conditions according to machine rigidity or work rigidity.
2. These parameters are for overhang length 3Dc. See right table for longer application.
3. In case of chatter occurring, recommended to reduce a_p or rpm and keep feed per tooth.
4. Use air blow.

Overhang (l/Dc)	n (min ⁻¹)	V_f (mm/min)
~ 3Dc	100%	100%
3Dc ~ 5Dc	70%	70%
5Dc ~ 10Dc	50%	50%

5-AXIS Series

■ Recommended cutting conditions



● TPM Type - with Tip R

Material	Grade	Tool dia.(mm)							
		16				20			
		a_p (mm)	a_e (mm)	n (min^{-1})	V_f (mm/min)	a_p (mm)	a_e (mm)	n (min^{-1})	V_f (mm/min)
Carbon steel (S50C, S55C) below 250HB	JC8015	0.1	0.2	15,920	1,590	0.1	0.2	12,730	1,530
Cast steel (GM190, ICD5) below 285HB	JC8015	0.1	0.2	15,920	1,590	0.1	0.2	12,730	1,530
Tool & die steel (SKD61, SKD11) below 255HB	JC8015	0.1	0.2	15,920	1,590	0.1	0.2	12,730	1,530
Mold steel (HPM7, PX5, P20) 30-36 HRC	JC8015	0.1	0.2	14,920	1,490	0.1	0.2	11,940	1,430
Mold steel (NAK80, HPM1, P21) 38-43HRC	JC8015	0.1	0.2	13,930	1,390	0.1	0.2	11,140	1,110
Hardened die steel (SKD61, DAC, DHA) 42-52HRC	DH102	0.08	0.2	9,950	1,000	0.08	0.2	7,960	960
Hardened die steel (SKD11, SLD, DC11) 55-62HRC	DH102	0.08	0.2	8,950	900	0.08	0.2	7,160	860
Grey cast iron (FC250) 160-260HB	DH102	0.12	0.2	16,910	1,690	0.12	0.2	13,530	1,620
Nodular cast iron (FCD700) 170-300HB	DH102	0.12	0.2	15,920	1,590	0.12	0.2	12,730	1,530
Austenitic stainless steel (SUS304, 316, 317) 17Cr	JC8015	0.1	0.2	14,920	1,490	0.1	0.2	11,940	1,430
Ferritic & martensitic stainless steel (SUS403, 420J2, 430) 13Cr	JC8015	0.1	0.2	14,920	1,490	0.1	0.2	11,940	1,430
Titanium alloy (Ti-6Al-4V) 35-43HRC	JC8015	0.06	0.2	5,970	600	0.06	0.2	4,770	570
Heat resistant alloy (INCO718) 35-43HRC	JC8015	0.05	0.2	3,980	400	0.05	0.2	3,180	380

Note

1. Please adjust cutting conditions according to machine rigidity or work rigidity.
2. These parameters are for overhang length 3Dc. See right table for longer application.
3. In case of chatter occurring, recommended to reduce a_p or rpm and keep feed per tooth.
4. Use air blow.

Overhang (l/D_c)	n (min^{-1})	V_f (mm/min)
~ 3Dc	100%	100%
3Dc ~ 5Dc	70%	70%
5Dc ~ 10Dc	50%	50%

5-AXIS Series

■ Recommended cutting conditions



● LRM Type

Material	Grade	Tool dia.(mm)							
		16				20			
		ap (mm)	ae (mm)	n (min ⁻¹)	Vf (mm/min)	ap (mm)	ae (mm)	n (min ⁻¹)	Vf (mm/min)
Carbon steel (S50C, S55C) below 250HB	JC8015	0.15	~0.6	7,960	4,780	0.15	~0.7	6,370	4,460
Cast steel (GM190, ICD5) below 285HB	JC8015	0.15	~0.6	7,960	4,780	0.15	~0.7	6,370	4,460
Tool & die steel (SKD61, SKD11) below 255HB	JC8015	0.15	~0.6	7,960	4,780	0.15	~0.7	6,370	4,460
Mold steel (HPM7, PX5, P20) 30-36 HRC	JC8015	0.1	~0.6	7,960	3,980	0.1	~0.7	6,370	3,820
Mold steel (NAK80, HPM1, P21) 38-43HRC	JC8015	0.1	~0.6	6,960	3,480	0.1	~0.7	5,570	3,340
Hardened die steel (SKD61, DAC, DHA) 42-52HRC	DH102	0.1	~0.5	5,970	2,390	0.1	~0.6	4,770	2,390
Hardened die steel (SKD11, SLD, DC11) 55-62HRC	DH102	0.1	~0.5	4,970	1,990	0.1	~0.6	3,980	1,590
Hardened die steel (SKH,HAP) 55-62HRC	DH102	0.05	~0.25	3,980	1,190	0.05	~0.25	3,180	950
Grey cast iron (FC250) 160-260HB	DH102	0.15	~0.6	7,960	4,780	0.15	~0.7	6,370	4,460
Nodular cast iron (FCD700) 170-300HB	DH102	0.15	~0.6	6,960	4,180	0.15	~0.7	5,570	3,900
Austenitic stainless steel (SUS304, 316, 317) 17Cr	JC8015	0.15	~0.6	7,960	3,980	0.15	~0.7	6,370	3,820
Ferritic & martensitic stainless steel (SUS403, 420J2, 430) 13Cr	JC8015	0.15	~0.6	7,960	3,980	0.15	~0.7	6,370	3,820
Titanium alloy (Ti-6Al-4V) 35-43HRC	JC8015	0.1	~0.6	4,970	1,990	0.1	~0.7	3,980	1,990
Heat resistant alloy (INCO718) 35-43HRC	JC8015	0.1	~0.25	3,980	1,190	0.1	~0.3	3,180	1,270

Please refer to chart and formula below to calculate ap.

$$ae = 2 \sqrt{(R^2 - (R - H)^2)}$$

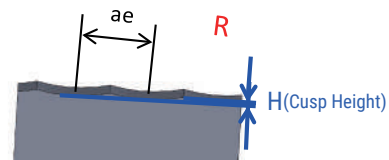

Pick amount ap(mm)		Cusp height (mm)									
Cat.No.	R	0.001	0.002	0.003	0.004	0.005	0.006	0.007	0.008	0.009	0.010
LRM-160-R20-BR32	32	0.51	0.72	0.88	1.01	1.13	1.24	1.34	1.43	1.52	1.60
LRM-200-R30-BR40	40	0.57	0.80	0.98	1.13	1.26	1.39	1.50	1.60	1.70	1.79

Note

1. Please adjust cutting conditions according to machine rigidity or work rigidity.
2. These parameters are for overhang length 3Dc. See right table for longer application.
3. In case of chatter occurring, recommended to reduce ap or rpm and keep feed per tooth.
4. Use air blow.

Overhang (l/Dc)	n (min ⁻¹)	Vf (mm/min)
~ 3Dc	100%	100%
5Dc ~ 10Dc	70%	70%
3Dc ~ 5Dc	50%	50%

5-AXIS Series

■ Recommended cutting conditions



● LRM Type

Material	Grade	Tool dia.(mm)							
		25				30			
		ap (mm)	ae (mm)	n (min ⁻¹)	Vf (mm/min)	ap (mm)	ae (mm)	n (min ⁻¹)	Vf (mm/min)
Carbon steel (S50C, S55C) below 250HB	JC8015	0.15	~0.8	5,730	4,010	0.15	~0.8	4,770	3,340
Cast steel (GM190, ICD5) below 285HB	JC8015	0.15	~0.8	5,730	4,010	0.15	~0.8	4,770	3,340
Tool & die steel (SKD61, SKD11) below 255HB	JC8015	0.15	~0.8	5,730	4,010	0.15	~0.8	4,770	3,340
Mold steel (HPM7, PX5, P20) 30-36 HRC	JC8015	0.1	~0.8	5,730	3,440	0.1	~0.8	4,770	2,860
Mold steel (NAK80, HPM1, P21) 38-43HRC	JC8015	0.1	~0.8	5,090	3,050	0.1	~0.8	4,240	2,540
Hardened die steel (SKD61, DAC, DHA) 42-52HRC	DH102	0.1	~0.7	4,460	2,230	0.1	~0.7	3,710	1,860
Hardened die steel (SKD11, SLD, DC11) 55-62HRC	DH102	0.1	~0.7	3,820	1,530	0.1	~0.7	3,180	1,270
Hardened die steel (SKH,HAP) 55-62HRC	DH102	0.05	~0.25	2,550	770	0.05	~0.25	2,120	640
Grey cast iron (FC250) 160-260HB	DH102	0.15	~0.8	5,730	4,010	0.15	~0.8	4,770	3,340
Nodular cast iron (FCD700) 170-300HB	DH102	0.15	~0.8	5,730	4,010	0.15	~0.8	4,770	3,340
Austenitic stainless steel (SUS304, 316, 317) 17Cr	JC8015	0.15	~0.8	5,730	3,440	0.15	~0.8	4,770	2,860
Ferritic & martensitic stainless steel (SUS403, 420J2, 430) 13Cr	JC8015	0.15	~0.8	5,730	3,440	0.15	~0.8	4,770	2,860
Titanium alloy (Ti-6Al-4V) 35-43HRC	JC8015	0.1	~0.8	3,180	1,590	0.1	~0.8	2,650	1,330
Heat resistant alloy (INCO718) 35-43HRC	JC8015	0.1	~0.3	2,550	1,020	0.1	~0.3	2,120	850

Please refer to chart and formula below to calculate ap.

$$ae = 2 \sqrt{(R^2 - (R - H)^2)}$$

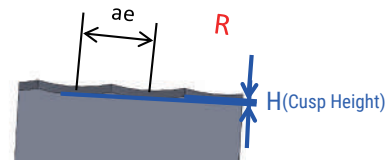

Pick amount ap(mm)		Cusp height (mm)									
Cat.No.	R	0.001	0.002	0.003	0.004	0.005	0.006	0.007	0.008	0.009	0.010
LRM-250-R30-BR50	50	0.63	0.89	1.10	1.26	1.41	1.55	1.67	1.79	1.90	2.00
LRM-300-R30-BR60	60	0.69	0.98	1.20	1.39	1.55	1.70	1.83	1.96	2.08	2.19

Note

1. Please adjust cutting conditions according to machine rigidity or work rigidity.
2. These parameters are for overhang length 3Dc. See right table for longer application.
3. In case of chatter occurring, recommended to reduce ap or rpm and keep feed per tooth.
4. Use air blow.

Overhang (ℓ/Dc)	n (min ⁻¹)	Vf (mm/min)
~ 3Dc	100%	100%
5Dc ~ 10Dc	70%	70%
3Dc ~ 5Dc	50%	50%

5-AXIS Series

Recommended cutting conditions



STLP Type - with Barrel R

Material		Tool dia. (mm)					
		16			20		
		ℓ (mm)	n (min ⁻¹)	V _f (mm/min)	ℓ (mm)	n (min ⁻¹)	V _f (mm/min)
Carbon steel (S50C, S55C) below 250HB	 $ap \leq 3$ $ae \leq 0.02Dc$	70	10,000	3,200~4,000	70	8,000	2,600~3,200
		110	8,800	2,500~3,200	125	7,200	2,000~2,600
		150	7,800	1,900~2,500	175	6,400	1,600~2,100
Alloy steel, Tool & die steel, Mold steel (SKD, SKH, NAK) below 45HB	 $ap \leq 3$ $ae \leq 0.02Dc$	70	10,000	2,400~3,200	70	8,000	2,000~2,600
		110	8,800	1,800~2,500	125	7,200	1,500~2,100
		150	7,800	1,300~1,900	175	6,400	1,300~1,600
Hardened die steel (SKD61, DAC, DHA) 42-52HRC	 $ap \leq 3$ $ae \leq 0.02Dc$	70	10,000	2,000~2,800	70	8,000	1,600~2,300
		110	8,800	1,400~2,100	125	7,200	1,200~1,800
		150	7,800	1,000~1,600	175	6,400	800~1,300
Austenitic stainless steel (SUS304, 316, 317) 17Cr	 $ap \leq 3$ $ae \leq 0.02Dc$	70	10,000	2,000~2,800	70	8,000	1,600~2,300
		110	8,800	1,400~2,100	125	7,200	1,200~1,800
		150	7,800	1,000~1,600	175	6,400	800~1,300
Titanium alloy (Ti-6Al-4V) 35-43HRC	 $ap \leq 3$ $ae \leq 0.02Dc$	70	8,000	1,000~1,600	70	6,400	800~1,200
		110	7,000	800~1,400	125	5,600	700~900
		150	6,000	500~1,000	175	4,800	400~800
Heat resistant alloy (INCO718) 35-43HRC	 $ap \leq 3$ $ae \leq 0.02Dc$	70	4,000	320~480	70	3,200	260~380
		110	3,500	280~420	125	2,800	220~340
		150	3,000	240~360	175	2,400	190~290

Please refer to chart and formula below to calculate ap .

$$ap = 2 \sqrt{(R^2 - (R - H)^2)}$$

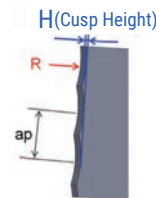

Pick amount ap (mm)		Cusp height (mm)									
Cat.No.	R	0.001	0.002	0.003	0.004	0.005	0.006	0.007	0.008	0.009	0.010
STLP-4160T20R4-M8	1500										
STLP-4200T15R4-M10		3.46	4.90	6.00	6.93	7.75	8.49	9.17	9.80	10.39	10.95
STLP-4200T20R5-M10											

Note

1. Please apply coolant according to work material.
2. In case of chatter occurring, recommended to reduce ap or rpm and keep feed per tooth.
3. In case of machine rpm not enough, reduce V_f at same rate.

5-AXIS Series

Recommended cutting conditions



STLP Type - with Tip R

Material	Tool dia.(mm)							
			16			20		
	ap (mm)	ae (mm)	ℓ (mm)	n (min ⁻¹)	Vf (mm/min)	ℓ (mm)	n (min ⁻¹)	Vf (mm/min)
Carbon steel (S50C, S55C) below 250HB	 ap ≤ 0.4 ae ≤ 0.25		70	7,800	1,090~1,400	70	6,300	880~1,100
			110	7,100	850~1,100	125	5,700	680~910
			150	6,300	630~880	175	5,000	500~700
Alloy steel, Tool & die steel, Mold steel (SKD, SKH, NAK) below 45HB	 ap ≤ 0.4 ae ≤ 0.25		70	7,800	780~1,090	70	6,300	630~880
			110	7,100	560~850	125	5,700	450~680
			150	6,300	440~690	175	5,000	350~550
Hardened die steel (SKD61, DAC, DHA) 42-52HRC	 ap ≤ 0.3 ae ≤ 0.2		70	6,300	310~560	70	5,000	250~400
			110	5,500	270~380	125	4,400	220~290
			150	4,700	180~320	175	3,800	140~260
Austenitic stainless steel (SUS304, 316, 317) 17Cr	 ap ≤ 0.3 ae ≤ 0.2		70	7,800	700~930	70	6,300	560~750
			110	7,100	490~780	125	5,700	390~620
			150	6,300	310~560	175	5,000	250~450
Titanium alloy (Ti-6Al-4V) 35-43HRC	 ap ≤ 0.3 ae ≤ 0.2		70	5,900	230~470	70	4,700	180~370
			110	5,100	200~350	125	4,100	160~280
			150	4,300	170~300	175	3,500	140~240
Heat resistant alloy (INCO718) 35-43HRC	 ap ≤ 0.2 ae ≤ 0.15		70	4,000	320~480	70	3,200	260~380
			110	3,500	280~420	125	2,800	220~340
			150	3,000	240~360	175	2,400	190~290

Note

1. Please apply coolant according to work material.
2. In case of chatter occurring, recommended to reduce ap or rpm and keep feed per tooth.
3. In case of machine rpm not enough, reduce Vf at same rate.

5-AXIS Series

Recommended cutting conditions

FJVA Type - with Barrel R



Material	ap (mm) ae (mm)	Tool dia.(mm)							
		6		8		10		12	
		n (min ⁻¹)	Vf (mm/min)	n (min ⁻¹)	Vf (mm/min)	n (min ⁻¹)	Vf (mm/min)	n (min ⁻¹)	Vf (mm/min)
Carbon steel (S50C, S55C) below 250HB	ap ≤ 0.3 ae ≤ 3	15,920	2,550	13,930	2,510	12,730	2,550	10,610	2,120
Alloy steel, Tool & die steel, Mold steel (SKD, SKH, NAK) below 45HB	ap ≤ 0.3 ae ≤ 3	10,610	1,270	9,950	1,390	9,550	1,530	7,960	1,270
Hardened die steel (SKD61, DAC, DHA) 42-52HRC	ap ≤ 0.02Dc ae ≤ 2.5	8,490	850	7,960	960	7,640	1,070	6,370	890
Hardened die steel (SKD11, SL, DC11) 55-62HRC	ap ≤ 0.01Dc ae ≤ 2	6,900	550	6,370	640	6,050	730	5,040	600
Austenitic stainless steel (SUS304, 316, 317) 17Cr	ap ≤ 0.02Dc ae ≤ 2	10,610	1,060	9,950	1,190	9,550	1,340	7,960	1,110
Titanium alloy (Ti-6Al-4V)	ap ≤ 0.02Dc ae ≤ 2	5,310	420	4,770	480	4,140	500	3,450	410
Heat resistant alloy (INCO718) 35-43HRC	ap ≤ 0.01Dc ae ≤ 1	3,180	250	2,790	220	2,550	200	2,120	170

Please refer to chart and formula below to calculate ap.

$$ae = 2 \sqrt{(R^2 - (R - H)^2)}$$

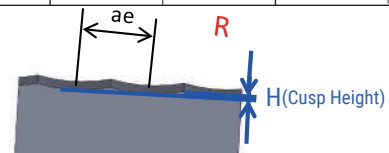

Pick amount ap(mm)		Cusp height (mm)									
Cat.No.	R	0.001	0.002	0.003	0.004	0.005	0.006	0.007	0.008	0.009	0.010
FJVA4060S06-R250	250										
FJVA4080S08-R250											
FJVA4100S10-R250		1.41	2.00	2.45	2.83	3.16	3.46	3.74	4.00	4.24	4.47
FJVA4120S12-R250											

- Note
1. Please apply coolant according to work material.
 2. In case of chatter occurring, recommended to reduce ap or rpm and keep feed per tooth.
 3. In case of machine rpm not enough, reduce Vf at same rate.

5-AXIS Series

■ Definition of edge shape for programming

● When using taper holder (MQT-***A03/05 type)

Fig.1 XPHW/T

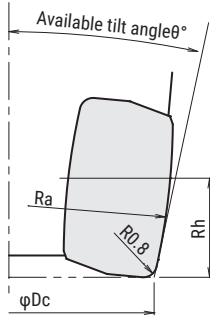
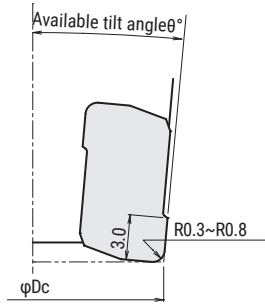

Fig.2 YPHW



● imensions when using XPHW / T insert

available tilt angle	Cat.No	Dimensions (mm)			Fig
		φDc	Ra	Rh	
1°~6°	MQT-2016A03-M8	15.5	R64.19	8.76	1
3°~8°	MQT-2016A05-M8	15.5	R64.34	10.98	1
1°~6°	MQT-2020A03-M10	19.5	R63.34	8.67	1
3°~8°	MQT-2020A05-M10	19.5	R63.46	10.85	1

● imensions when using YPHW insert

available tilt angle	Cat.No	Dimensions (mm)		Fig
		φDc		
3°	MQT-2016A03-M8	16		2
5°	MQT-2016A05-M8	16		2
3°	MQT-2020A03-M10	20		2
5°	MQT-2020A05-M10	20		2

● When using straight holder (MQT-***A00 type)

Fig.3 XPHW/T

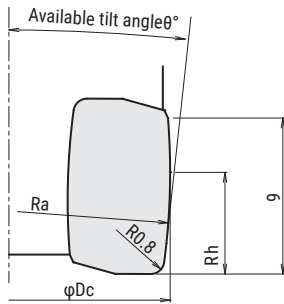

● Dimensions when using XPHW/T insert

available tilt angle	Cat.No	Dimensions (mm)			Fig
		φDc	Ra	Rh	
0°~3°	MQT-2016A00-M8	16	R63.27	5.48	3
0°~3°	MQT-4020A00-M10	20	R64.29	5.48	3
0°~3°	MQT-5025A00-M12	25	R63.26	5.48	3
0°~3°	MQT-6032A00-M16	32	R62.41	5.48	3
0°~3°	MQT-6035A00-M16	35	R62.16	5.48	3

● Dimensions when using YPHW insert

available tilt angle	Cat.No	Dimensions (mm)		Fig
		φDc		
0°	MQT-2016A00-M8	16		-
0°	MQT-4020A00-M10	20		-
0°	MQT-5025A00-M12	25		-
0°	MQT-6032A00-M16	32		-
0°	MQT-6035A00-M16	35		-

5-AXIS Series

Recommended cutting conditions

MQT type with XPHT/XPHW insert for finishing side wall + MSN shank

Material	Grade	Tool dia.(mm)														
		16					20					20				
		2N					2N					4N				
r (mm)	a_p (mm)	a_e (mm)	n (min ⁻¹)	V_f (mm/min)	r (mm)	a_p (mm)	a_e (mm)	n (min ⁻¹)	V_f (mm/min)	r (mm)	a_p (mm)	a_e (mm)	n (min ⁻¹)	V_f (mm/min)		
Carbon steel (S50C, S55C) below 250HB	JC8015 XPHT (XPHW)	~55	≤1.5	<0.12	12,000	4,800	~70	≤1.5	<0.12	9,600	3,840	~70	≤1.5	<0.12	9,600	7,680
	(CX75)	55~80	≤1.2	<0.10	9,000	3,600	70~100	≤1.2	<0.10	7,200	2,880	70~100	≤1.2	<0.10	7,200	5,760
		80~105	≤1.0	<0.10	7,200	2,880	100~130	≤1.0	<0.10	5,760	2,300	100~130	≤1.0	<0.10	5,760	4,600
		105~160	≤1.0	<0.10	6,000	2,400	130~200	≤1.0	<0.10	4,800	1,920	130~200	≤1.0	<0.10	4,800	3,840
Tool & die steel (SKD61, SKD11) below 255HB	JC8015 XPHT (XPHW)	~55	≤1.5	<0.12	10,000	4,000	~70	≤1.5	<0.12	8,000	3,200	~70	≤1.5	<0.12	8,000	6,400
	(CX75)	55~80	≤1.2	<0.10	7,500	3,000	70~100	≤1.2	<0.10	6,000	2,400	70~100	≤1.2	<0.10	6,000	4,800
		80~105	≤1.0	<0.10	6,000	2,400	100~130	≤1.0	<0.10	4,800	1,920	100~130	≤1.0	<0.10	4,800	3,840
		105~160	≤1.0	<0.10	5,000	2,000	130~200	≤1.0	<0.10	4,000	1,600	130~200	≤1.0	<0.10	4,000	3,200
Mold steel (HPM7, PX5, P20) 30-36 HRC	JC8015 XPHT (XPHW)	~55	≤1.2	<0.12	9,000	3,600	~70	≤1.2	<0.12	7,200	2,880	~70	≤1.2	<0.12	7,200	5,760
	(DH102)	55~80	≤1.0	<0.10	6,800	2,720	70~100	≤1.0	<0.10	5,400	2,160	70~100	≤1.0	<0.10	5,400	4,320
		80~105	≤0.8	<0.10	5,400	2,160	100~130	≤0.8	<0.10	4,320	1,730	100~130	≤0.8	<0.10	4,320	3,460
		105~160	≤0.8	<0.10	4,500	1,800	130~200	≤0.8	<0.10	3,600	1,440	130~200	≤0.8	<0.10	3,600	2,880
Mold steel (NAK80, HPM1, P21) 38-43HRC	DH102 XPHW	~55	≤1.0	<0.12	8,000	3,200	~70	≤1.0	<0.12	6,400	2,560	~70	≤1.0	<0.12	6,400	5,120
	(JC8015)	55~80	≤0.8	<0.10	6,000	2,400	70~100	≤0.8	<0.10	4,800	1,920	70~100	≤0.8	<0.10	4,800	3,840
		80~105	≤0.6	<0.10	4,800	1,920	100~130	≤0.6	<0.10	3,840	1,540	100~130	≤0.6	<0.10	3,840	3,080
		105~160	≤0.6	<0.10	4,000	1,600	130~200	≤0.6	<0.10	3,200	1,280	130~200	≤0.6	<0.10	3,200	2,560
Hardened die steel (SKD61, DAC, DHA) 42-52HRC	DH102 XPHW	~55	≤1.0	<0.10	5,000	1,500	~70	≤1.0	<0.10	4,000	1,200	~70	≤1.0	<0.10	4,000	2,400
	(JC8015)	55~80	≤0.8	<0.08	3,750	1,130	70~100	≤0.8	<0.08	3,000	900	70~100	≤0.8	<0.08	3,000	1,800
		80~105	≤0.6	<0.08	3,000	900	100~130	≤0.6	<0.08	2,400	720	100~130	≤0.6	<0.08	2,400	1,440
		105~160	≤0.6	<0.08	2,500	750	130~200	≤0.6	<0.08	2,000	600	130~200	≤0.6	<0.08	2,000	1,200
Hardened die steel (SKD11, SLD, DC11) 55-62HRC	DH102 XPHW	~55	≤1.0	<0.10	3,600	720	~70	≤1.0	<0.10	2,860	570	~70	≤1.0	<0.10	2,860	1,140
		55~80	≤0.8	<0.08	2,700	540	70~100	≤0.8	<0.08	2,140	430	70~100	≤0.8	<0.08	2,140	860
		80~105	≤0.6	<0.08	2,160	430	100~130	≤0.6	<0.08	1,720	340	100~130	≤0.6	<0.08	1,720	680
		105~160	≤0.6	<0.08	1,800	360	130~200	≤0.6	<0.08	1,430	290	130~200	≤0.6	<0.08	1,430	580
Grey & Nodular cast iron (FC, FCD) below 300HB	JC8015 XPHW (XPHT)	~55	≤1.5	<0.12	12,000	6,000	~70	≤1.5	<0.12	9,600	4,800	~70	≤1.5	<0.12	9,600	9,600
	(DH102)	55~80	≤1.2	<0.10	9,000	4,500	70~100	≤1.2	<0.10	7,200	3,600	70~100	≤1.2	<0.10	7,200	7,200
		80~105	≤1.0	<0.10	7,200	3,600	100~130	≤1.0	<0.10	5,760	2,880	100~130	≤1.0	<0.10	5,760	5,760
		105~160	≤1.0	<0.10	6,000	3,000	130~200	≤1.0	<0.10	4,800	2,400	130~200	≤1.0	<0.10	4,800	4,800
Stainless steel (SUS304) below 250HB	JC8015 XPHT (XPHW)	~55	≤1.2	<0.12	10,000	4,000	~70	≤1.2	<0.12	8,000	3,200	~70	≤1.2	<0.12	8,000	6,400
		55~80	≤1.0	<0.10	7,500	3,000	70~100	≤1.0	<0.10	6,000	2,400	70~100	≤1.0	<0.10	6,000	4,800
		80~105	≤0.8	<0.10	6,000	2,400	100~130	≤0.8	<0.10	4,800	1,920	100~130	≤0.8	<0.10	4,800	3,840
		105~160	≤0.8	<0.10	5,000	2,000	130~200	≤0.8	<0.10	4,000	1,600	130~200	≤0.8	<0.10	4,000	3,200

Cusp height: XPHT/W

Cusp Height (μm)	a_p (mm)	Cusp Height (μm)	a_p (mm)
0.50	0.5	3.35	1.3
0.71	0.6	3.89	1.4
0.97	0.7	4.46	1.5
1.27	0.8	5.08	1.6
1.61	0.9	5.73	1.7
1.98	1.0	6.43	1.8
2.40	1.1	7.16	1.9
2.86	1.2	7.94	2.0

Note

- Figures to be adjusted according to machine rigidity or work rigidity.
- If chattering occurs, recommended to reduce a_p and a_e .
- Use air blow.

5-AXIS Series

■ Recommended cutting conditions

MQT type with XPHT/XPHW insert for finishing side wall + MSN shank

Material	Grade	Tool dia.(mm)									
		25					32/35				
		5N					6N				
		r (mm)	ap (mm)	ae (mm)	n (min ⁻¹)	Vf (mm/min)	r (mm)	ap (mm)	ae (mm)	n (min ⁻¹)	Vf (mm/min)
Carbon steel (S50C, S55C) below 250HB	JC8015 XPHT (XPHW) (CX75)	~90	≤1.5	<0.12	7,640	7,640	~120	≤1.5	<0.12	5,460	6,550
		90~125	≤1.2	<0.10	5,730	5,730	120~175	≤1.2	<0.10	4,100	4,920
		125~160	≤1.0	<0.10	4,580	4,580	175~225	≤1.0	<0.10	3,280	3,940
		160~250	≤1.0	<0.10	3,820	3,820	225~320	≤1.0	<0.10	2,730	3,280
Tool & die steel (SKD61, SKD11) below 255HB	JC8015 XPHT (XPHW) (CX75)	~90	≤1.5	<0.12	6,400	6,400	~120	≤1.5	<0.12	4,550	5,460
		90~125	≤1.2	<0.10	4,800	4,800	120~175	≤1.2	<0.10	3,410	4,090
		125~160	≤1.0	<0.10	3,840	3,840	175~225	≤1.0	<0.10	2,730	3,280
		160~250	≤1.0	<0.10	3,200	3,200	225~320	≤1.0	<0.10	2,280	2,740
Mold steel (HPM7, PX5, P20) 30-36 HRC	JC8015 XPHT (XPHW) (DH102)	~90	≤1.2	<0.12	5,730	5,730	~120	≤1.2	<0.12	4,090	4,910
		90~125	≤1.0	<0.10	4,300	4,300	120~175	≤1.0	<0.10	3,070	3,680
		125~160	≤0.8	<0.10	3,440	3,440	175~225	≤0.8	<0.10	2,450	2,940
		160~250	≤0.8	<0.10	2,870	2,870	225~320	≤0.8	<0.10	2,050	2,460
Mold steel (NAK80, HPM1, P21) 38-43HRC	DH102 XPHW (JC8015)	~90	≤1.0	<0.12	5,100	5,100	~120	≤1.0	<0.12	3,640	4,370
		90~125	≤0.8	<0.10	3,830	3,830	120~175	≤0.8	<0.10	2,730	3,280
		125~160	≤0.6	<0.10	3,060	3,060	175~225	≤0.6	<0.10	2,180	2,620
		160~250	≤0.6	<0.10	2,550	2,550	225~320	≤0.6	<0.10	1,820	2,180
Hardened die steel (SKD61, DAC, DHA) 42-52HRC	DH102 XPHW (JC8015)	~90	≤1.0	<0.10	3,180	2,380	~120	≤1.0	<0.10	2,280	2,050
		90~125	≤0.8	<0.08	2,380	1,780	120~175	≤0.8	<0.08	1,710	1,540
		125~160	≤0.6	<0.08	1,910	1,430	175~225	≤0.6	<0.08	1,370	1,230
		160~250	≤0.6	<0.08	1,590	1,190	225~320	≤0.6	<0.08	1,140	1,030
Hardened die steel (SKD11, SLD, DC11) 55-62HRC	DH102 XPHW	~90	≤1.0	<0.10	2,300	1,150	~120	≤1.0	<0.10	1,640	980
		90~125	≤0.8	<0.08	1,720	860	120~175	≤0.8	<0.08	1,230	740
		125~160	≤0.6	<0.08	1,380	690	175~225	≤0.6	<0.08	980	590
		160~250	≤0.6	<0.08	1,150	580	225~320	≤0.6	<0.08	820	490
Grey & Nodular cast iron (FC, FCD) below 300HB	JC8015 XPHW (XPHT) (DH102)	~90	≤1.5	<0.12	7,640	9,550	~120	≤1.5	<0.12	5,460	8,190
		90~125	≤1.2	<0.10	5,730	7,160	120~175	≤1.2	<0.10	4,100	6,150
		125~160	≤1.0	<0.10	4,580	5,720	175~225	≤1.0	<0.10	3,280	4,920
		160~250	≤1.0	<0.10	3,820	4,780	225~320	≤1.0	<0.10	2,730	4,100
Stainless steel (SUS304) below 250HB	JC8015 XPHT (XPHW)	~90	≤1.2	<0.12	6,400	6,400	~120	≤1.2	<0.12	4,550	5,460
		90~125	≤1.0	<0.10	4,800	4,800	120~175	≤1.0	<0.10	3,410	4,090
		125~160	≤0.8	<0.10	3,840	3,840	175~225	≤0.8	<0.10	2,730	3,280
		160~250	≤0.8	<0.10	3,200	3,200	225~320	≤0.8	<0.10	2,280	2,740

Cusp height: XPHT/W

Cusp Height (μm)	ap(mm)	Cusp Height (μm)	ap(mm)
0.50	0.5	3.35	1.3
0.71	0.6	3.89	1.4
0.97	0.7	4.46	1.5
1.27	0.8	5.08	1.6
1.61	0.9	5.73	1.7
1.98	1.0	6.43	1.8
2.40	1.1	7.16	1.9
2.86	1.2	7.94	2.0

Note

- Figures to be adjusted according to machine rigidity or work rigidity.
- If chattering occurs, recommended to reduce ap and ae.
- Use air blow.

SKS-GII

SKG/MSG Type

SKS-GII



High metal removal rate

Features 1

Provides stability even milling of deep cavities.

Features 2

4 corner positive insert with low cutting forces.



SKS-GII **SKG/MSG Type**

Features 3 Flat top insert

SKG-10 type insert : Max ap=1.5mm
 SKG-14 type insert : Max ap=2.5mm



Features 4 Chip breaker insert

Optimized cutting edge for machining of difficult to cut materials like titanium alloy.
 Effective for machining that requires reduced cutting loads or long overhang application.

 SM breaker for difficult to cut materials

 PM breaker for mould steel

Features 5

Insert grades for a wide range of materials
 <JC8118><JC8050><JC7550><DS150>



 mould steel, hardened steel from 38HRC upto 50HRC
 JC8118

 mould steel, general steel below 36HRC
 JC8050

 Titanium alloy, stainless steel
 JC7550, DS150

ISO	P					M					K				S				H		
	P01	P10	P20	P30	P40	M01	M10	M20	M30	M40	K01	K10	K20	K30	S01	S10	S20	S30	H01	H10	H20
Range	JC8118										JC8118								JC8118		
	JC8050														NEW DS150						
						JC7550									JC7550						

Features 6
Excellent chip evacuation

SKS-GII

SKG/MSG Type

■ **SKG10 Facemill Type**



Through coolant hole

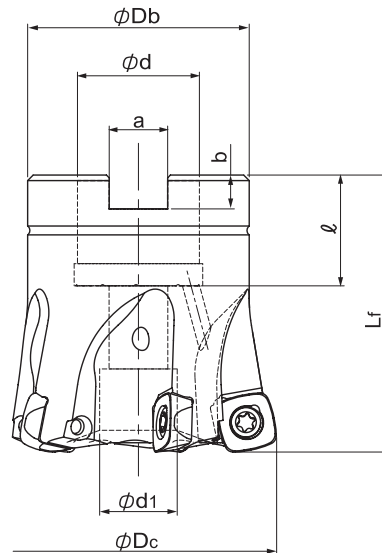

Cat.No.	Stock	No. of inserts	Dimensions (mm)								Arbor set bolt	Weight (kg)	Inserts
			ϕD_c	L_f	ϕD_b	ϕd	ϕd_1	a	b	l			
SKG-4050R-10-22	●	4	50	50	40	22	14	10.4	6.3	20	M10X1.5X35*	0.3	SPNW10...; SPET10...; SPMT10...
SKG-5050R-10-22	●	5					52				16.6	M10X1.5X35*	
SKG-5052R-10-22	●		63				48	17	M10	0.5			
SKG-5063R-10-22	●				27	20		12.4	7	22	M12X1.75X30*	0.5	
SKG-5063R-10-27	●	6	63		48	22	17	10.4	6.3	20	M10	0.5	
SKG-6063R-10-22	●			66		50	27	20	12.4	7	22	M12X1.75X30*	
SKG-6063R-10-27	●		80		60							M12X1.75X30*	
SKG-6066R-10-27	●			M12X1.75X30*		0.9							
SKG-6080R-10-27	●									M12X1.75X30*	0.9		

Screw	Torque(N.m)	Wrench
TSW-3509H	3.0	A-15T

SKS-GII **SKG/MSG Type**

■ **MSG10 Modular Head Type**

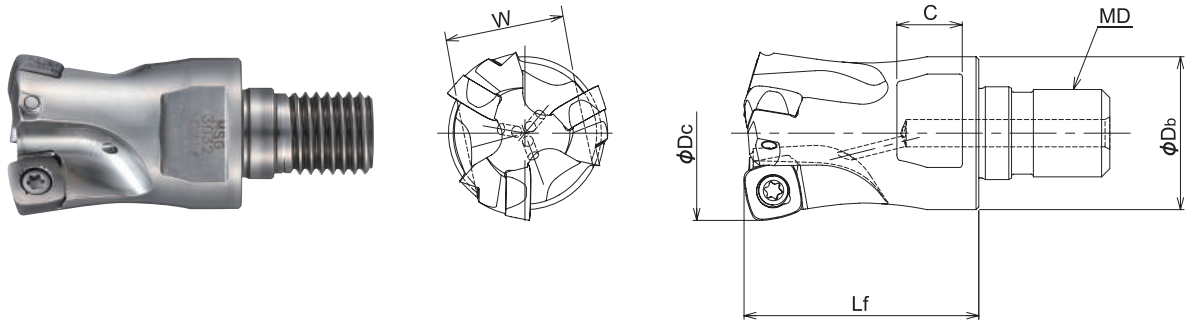
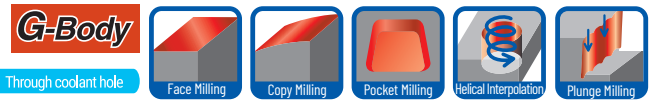

Cat.No.	Stock	No. of inserts	Dimensions (mm)						Inserts
			ϕD_c	L_f	ϕD_b	MD	C	W	
MSG-2025-10-M12	●	2	25	35	23	M12	11	19	SPNW10...; SPET10...; SPMT10...
MSG-3032-10-M16	●	3	32	43	28	M16	12	22	
MSG-3035-10-M16	●		35		14		26		
MSG-4040-10-M16	●	4	40		32		14	26	
MSG-4042-10-M16	●		42	14	26				

Screw	Torque(N.m)	Wrench
TSW-3509H	3.0	A-15

SKS-GII **SKG/MSG Type**

■ **SKG/MSG10 Type Insert**



Fig. 1

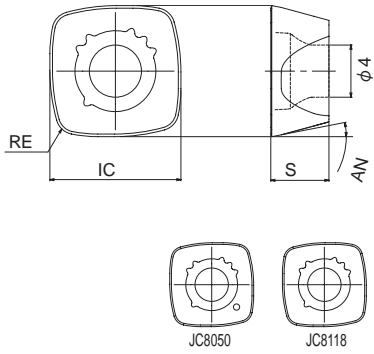

Fig. 2

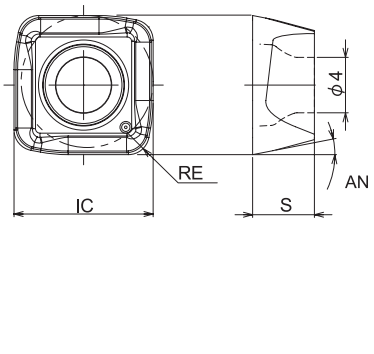

Fig. 3

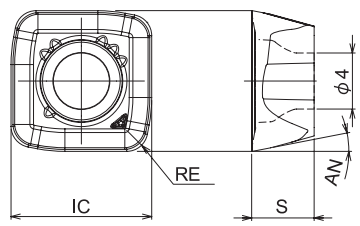
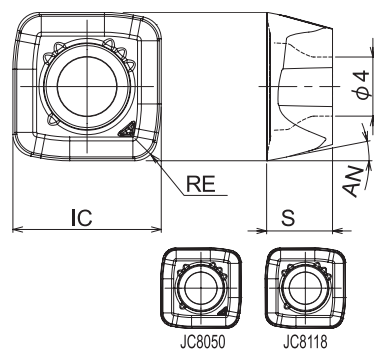

Fig. 4



Cat.No.	Tolerance	PVD Coating				Dimensions (mm)				Fig.
		DS150	JC7550	JC8050	JC8118	RE	IC	S	AN	
SPNW100415ZTR	N			●	●	1.5	10	4.46	11°	1
SPET100415ZPER-SM	E	●	●							2
SPMT100415ZPER-SM	M	●	●							3
SPMT100415ZPTR-PM				●	●					4

SKS-GII **SKG/MSG Type**

■ **MSG10 Modular Head Type**

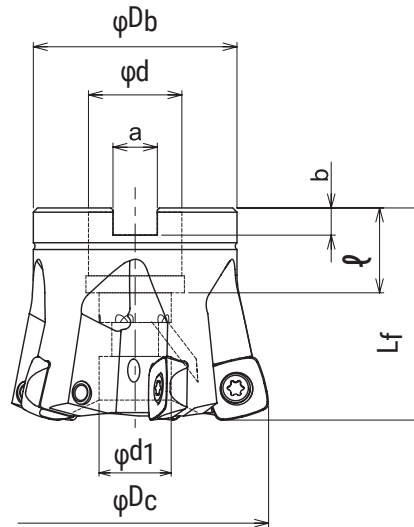
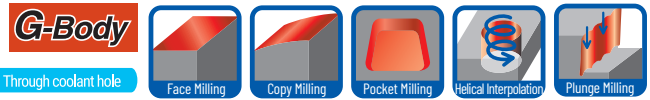

Cat.No.	Stock	No. of inserts	Dimensions (mm)								Arbor set bolt	Weight (kg)	Inserts	Fig.
			φDc	Lf	φDb	φd	φd1	a	b	ρ				
SKG-4050R-14-22	●	4	50	50	40	22	14	10.4	6.3	19.05	M10X1.5X35*	0.3	SPNW14...; SPMT14...	1
SKG-4052R-14-22	●		52		42		17				M10X1.5X35*	0.3		
SKG-4063R-14-22	●		63		48		20				M10	0.5		
SKG-4063R-14-27	●		63		48	20	M12X1.75X35*	0.5						
SKG-5066R-14-27	●	5	66	50	27	20	12.4	7	22	M12X1.75X35*	0.5			
SKG-5080R-14-27	●		80	60	37	M12X1.75X35*	0.8							
SKG-6100R-14-32	●		100	63	70	32	45	14.4	8	25	M16	1.6		

Screw	Torque(N.m)	Wrench
CSW-513H	5.5	A-20

SKS-GII **SKG/MSG Type**

■ **SKG14 Type Insert**



Fig. 1

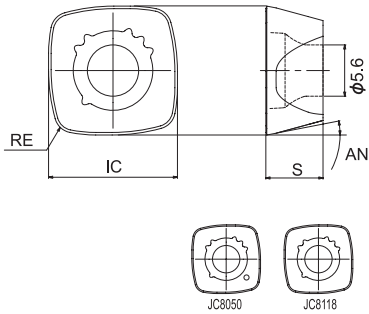

Fig. 2

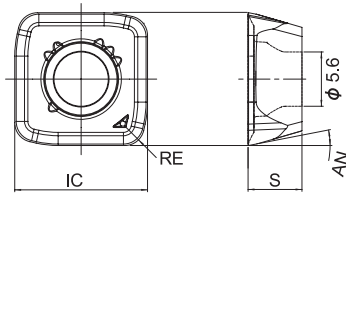
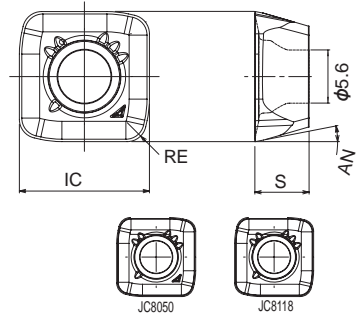

Fig. 3



Cat.No.	Tolerance	PVD Coating				Dimensions (mm)				Fig.
		DS150	JC7550	JC8050	JC8118	RE	IC	S	AN	
SPNW140515ZTR	N			●	●	1.5	13.7	5.56	11°	1
SPMT140520ZPER-SM	M	●	●			2				2
SPMT140520ZPTR-PM				●	●					3

SKS-GII **SKG/MSG Type**

■ Definition of corner shape for programming

● SPNW100415ZTR

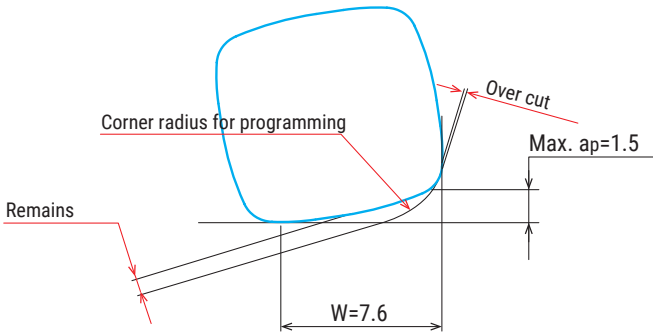

● SPE(M)T100415ZPER-SM
SPMT100415ZPTR-PM

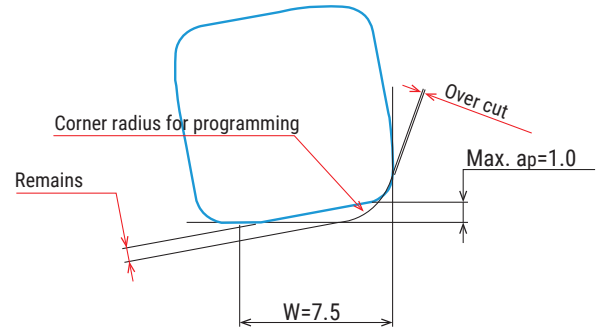

Corner radius for programming	Over cut	Remains
R2.5	0	0.99
R3.0 (Standard)	0	0.84
R3.5	0.09	0.71
R4.0	0.23	0.59

Corner radius for programming	Over cut	Remains
R2.5 (Standard)	0	0.77
R3.0	0.09	0.68
R3.5	0.25	0.60
R4.0	0.43	0.52

● SPNW140515ZTR

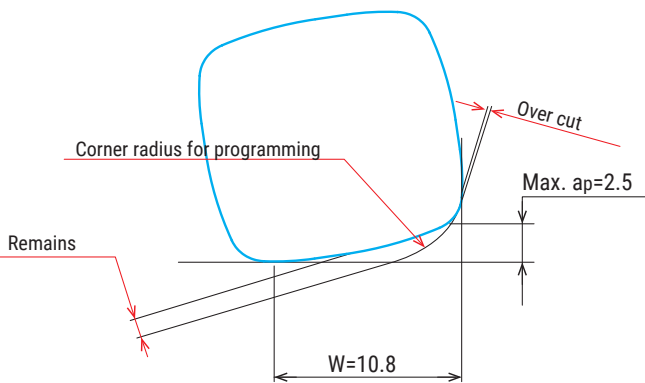

● SPMT140520ZPER-SM
SPMT140520ZPTR-PM

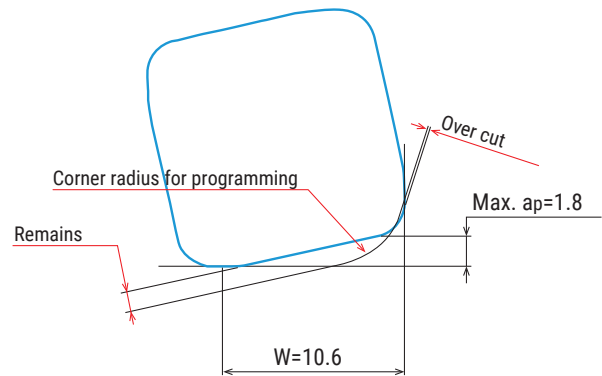

Corner radius for programming	Over cut	Remains
R3.5	0	1.60
R4.0 (Standard)	0	1.46
R4.5	0.06	1.32
R5.0	0.17	1.19

Corner radius for programming	Over cut	Remains
R3.5 (Standard)	0	1.35
R4.0	0.02	1.25
R4.5	0.14	1.12
R5.0	0.29	1.05

SKS-GII

SKG/MSG Type

■ **Recommended Data for Profile Milling**

Ramping

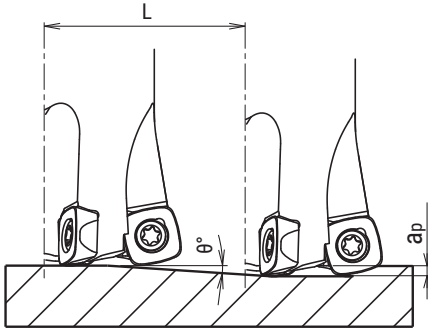

Helical interpolation

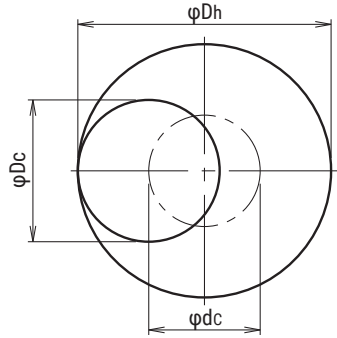

- Calculation of tool pass dia.

$$\varphi_{Dc} = \varphi_{Dh} - \varphi_{Dc}$$

Tool pass dia. Bore dia. Tool Dia.

- Depth of cut per one circuit should not exceed max. depth of cut Ap
- Down cutting is recommended, tool pass rotation should be counterclockwise

● In case of ramping and helical interpolation, apply 70% or less feed (Vf) from standard cutting condition table.

● **SPNW100415ZTR / SPNW140515ZTR**

Cat.No.	Tool dia. (mm)	Effective Cutting dia. (mm)	Max. depth of cut: ap (mm)	Ramping		Helical interpolation	
				Max. ramping angle θ	Total cutting length at Max. (ap) : L (mm)	Min. Bore dia. Dh min. (mm)	Max. Bore dia. Dh max. (mm)
MSG-2025-10	25	9.8	1.5	1°	85.9	36	48
MSG-3032-10	32	16.8	1.5	1°	85.9	50	62
MSG-3035-10	35	19.8	1.5	1°	85.9	56	70
MSG-4040-10	40	24.8	1.5	1°	85.9	66	78
MSG-4042-10	42	26.8	1.5	1°	85.9	70	82
SKG-*050R-10	50	34.8	1.5	1°	85.9	86	98
SKG-5052R-10	52	36.8	1.5	1°	85.9	90	102
SKG-*063R-10	63	47.8	1.5	0°45'	114.6	112	124
SKG-6066R-10	66	50.8	1.5	0°45'	114.6	118	130
SKG-6080R-10	80	64.8	1.5	0°30'	171.9	146	158
SKG-4050R-14	50	28.4	2.5	1°	143.2	80	98
SKG-4052R-14	52	30.4	2.5	1°	143.2	84	102
SKG-*063R-14	63	41.4	2.5	0°45'	191	106	124
SKG-5066R-14	66	44.4	2.5	0°45'	191	112	130
SKG-5080R-14	80	58.4	2.5	0°30'	286.5	140	158
SKG-6100R-14	100	78.4	2.5	0°20'	430	180	198
SKG-6125R-14	125	103.4	2.5	0°20'	430	230	248
SKG-7160R-14	160	138.4	2.5	0°15'	573	300	318

SKS-GII **SKG/MSG Type**

■ Recommended Data for Profile Milling

Ramping

Helical interpolation

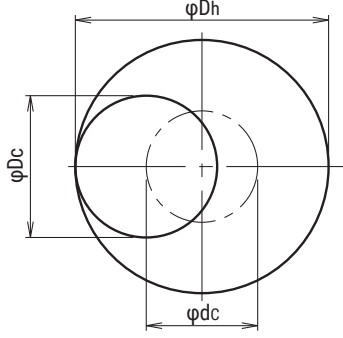
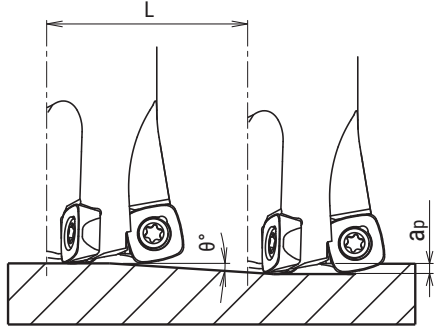

- Calculation of tool pass dia.

$$\varphi_{Dc} = \varphi_{Dh} - \varphi_{Dc}$$
 Tool pass dia. Bore dia. Tool Dia.
- Depth of cut per one circuit should not exceed max. depth of cut Ap
- Down cutting is recommended, tool pass rotation should be counterclockwise

● In case of ramping and helical interpolation, apply 70% or less feed (Vf) from standard cutting condition table.

- SPE (M) T100415ZPER-SM, SPMT100415ZPTR-PM
- SPMT140520ZPER-SM, SPMT140520ZPTR-PM

Cat.No.	Tool dia. (mm)	Effective Cutting dia. (mm)	Max. depth of cut : ap (mm)	Ramping		Helical interpolation	
				Max. ramping angle θ	Total cutting length at Max. (ap) : L (mm)	Min. Bore dia. Dh min. (mm)	Max. Bore dia. Dh max. (mm)
MSG-2025-10	25	10	1.0	1°	57.3	36	48
MSG-3032-10	32	17	1.0	1°	57.3	50	62
MSG-3035-10	35	20	1.0	1°	57.3	56	70
MSG-4040-10	40	25	1.0	1°	57.3	66	78
MSG-4042-10	42	27	1.0	1°	57.3	70	82
SKG-*050R-10	50	35	1.0	1°	57.3	86	98
SKG-5052R-10	52	37	1.0	1°	57.3	90	102
SKG-*063R-10	63	48	1.0	0°45'	76.4	112	124
SKG-6066R-10	66	51	1.0	0°45'	76.4	118	130
SKG-6080R-10	80	65	1.0	0°30'	114.6	146	158
SKG-4050R-14	50	28.8	1.8	1°	103.1	80	98
SKG-4052R-14	52	30.8	1.8	1°	103.1	84	102
SKG-*063R-14	63	41.8	1.8	0°45'	137.5	106	124
SKG-5066R-14	66	44.8	1.8	0°45'	137.5	112	130
SKG-5080R-14	80	58.8	1.8	0°30'	206.3	140	158
SKG-6100R-14	100	78.8	1.8	0°20'	206.3	180	198
SKG-6125R-14	125	123.8	1.8	0°20'	206.3	230	248
SKG-7160R-14	160	138.8	1.8	0°15'	412.5	300	318

SKS-GII

SKG/MSG Type

■ Recommended cutting conditions

● MSG Type + MSN shank

Material	Grade	Tool dia.(mm)														
		25					32/35					40/42				
		2N					3N					4N				
		ℓ (mm)	ap (mm)	ae (mm)	n (min ⁻¹)	Vf (mm/min)	ℓ (mm)	ap (mm)	ae (mm)	n (min ⁻¹)	Vf (mm/min)	ℓ (mm)	ap (mm)	ae (mm)	n (min ⁻¹)	Vf (mm/min)
Carbon steel (S50C, S55C) below 250HB	JC8050	~75	1	~9	2,290	6,870	~100	1	~14	1,640	7,380	~100	1	~24	1,430	8,580
	(JC8118)	125	0.8	~9	2,290	6,870	150	0.8	~14	1,640	7,380	150	0.8	~24	1,430	8,580
	SPNW SPMTPM	175	0.6	~9	2,290	6,410	210	0.6	~14	1,640	6,890	210	0.6	~24	1,430	8,010
Tool & die steel (SKD61, SKD11) below 255HB	JC8050	~75	1	~9	1,910	5,730	~100	1	~14	1,360	6,120	~100	1	~24	1,190	7,140
	(JC8118)	125	0.8	~9	1,910	5,730	150	0.8	~14	1,360	6,120	150	0.8	~24	1,190	7,140
	SPNW SPMTPM	175	0.6	~9	1,910	5,350	210	0.6	~14	1,360	5,710	210	0.6	~24	1,190	6,660
Mold steel (HPM7, PX5, P20) 30-36 HRC	JC8050	~75	1	~9	1,910	5,730	~100	1	~14	1,360	6,120	~100	1	~24	1,190	7,140
	(JC8118)	125	0.8	~9	1,910	5,730	150	0.8	~14	1,360	6,120	150	0.8	~24	1,190	7,140
	SPNW SPMTPM	175	0.6	~9	1,910	5,350	210	0.6	~14	1,360	5,710	210	0.6	~24	1,190	6,660
Mold steel (NAK80, HPM1, P21) 38-43HRC	JC8118	~75	1	~9	1,400	3,640	~100	1	~14	1,000	3,900	~100	1	~24	880	4,580
	(JC8050)	125	0.8	~9	1,400	3,640	150	0.8	~14	1,000	3,900	150	0.8	~24	880	4,580
	SPNW SPMTPM	175	0.6	~9	1,400	3,360	210	0.6	~14	1,000	3,600	210	0.6	~24	880	4,220
Hardened die steel (SKD61, DAC, DHA) 42-52HRC	JC8118	~75	0.6	~9	1,270	3,050	~100	0.6	~14	910	3,280	~100	0.6	~24	800	3,840
	SPNW	125	0.4	~9	1,270	3,050	150	0.4	~14	910	3,280	150	0.4	~24	800	3,840
		175	0.3	~9	1,270	2,540	210	0.3	~14	910	2,730	210	0.3	~24	800	3,200
Gery & Nodular cast iron (FC, FCD) below 300HB	JC8118	~75	1.2★	~9	2,290	6,870	~100	1.2★	~14	1,640	7,380	~100	1.2★	~24	1,430	8,580
	SPNW	125	1	~9	2,290	6,870	150	1	~14	1,640	7,380	150	1	~24	1,430	8,580
	SPMTPM	175	0.8	~9	2,290	6,870	210	0.8	~14	1,640	7,380	210	0.8	~24	1,430	8,580
Stainless steel (SUS304) below 250HB	JC7550	~75	1	~9	1,910	3,820	~100	1	~14	1,360	4,080	~100	1	~24	1,190	4,760
	SPMT-SM	125	0.8	~9	1,910	3,820	150	0.8	~14	1,360	4,080	150	0.8	~24	1,190	4,760
	SPET-SM	175	0.6	~9	1,660	2,990	210	0.6	~14	1,180	3,190	210	0.6	~24	1,030	3,710
Titanium alloy (Ti-6Al-4V)	DS150	~75	1	~9	760	910	~100	1	~14	550	990	~100	1	~24	480	1,150
	SPMT-SM	125	0.8	~9	760	910	150	0.8	~14	550	990	150	0.8	~24	480	1,150
	SPET-SM	175	0.6	~9	760	760	210	0.6	~14	550	830	210	0.6	~24	480	960

Note

1. Please adjust cutting conditions according to machine rigidity or work rigidity. (the above table is guide for cutting on a #50 BT machine.)
2. In case of chatter occurring, recommended to reduce ap or rpm and keep feed per tooth.
3. ap should be reduced when using on low rigidity machine.
4. Use air blow.

★: ap ≤ 1.0 when using SPMT10/SPET10 insert.

SKS-GII**SKG/MSG Type**

■ Recommended cutting conditions

● SKG10 Type

Material	Grade	Tool dia.(mm)														
		50					50/52					63				
		4N					5N					5N				
		ℓ (mm)	a _p (mm)	a _e (mm)	n (min ⁻¹)	V _f (mm/min)	ℓ (mm)	a _p (mm)	a _e (mm)	n (min ⁻¹)	V _f (mm/min)	ℓ (mm)	a _p (mm)	a _e (mm)	n (min ⁻¹)	V _f (mm/min)
Carbon steel (S50C, S55C) below 250HB	JC8050 (JC8118) SPNW SPMT-PM	~150	1.5★	~32	1,020	7,340	~150	1.5★	~32	1,020	9,180	~150	1.5★	~44	810	7,290
		200	1.2★	~32	1,020	7,340	200	1.2★	~32	1,020	9,180	200	1.5★	~44	810	7,290
		250	0.8	~32	890	5,340	250	0.8	~32	890	6,680	250	1.2★	~44	710	5,330
		300	0.6	~32	830	4,980	300	0.6	~32	830	6,230	300	1	~44	660	4,950
		350	0.5	~32	830	4,650	350	0.5	~32	830	5,810	350	0.5	~44	660	4,620
Tool & die steel (SKD61, SKD11) below 255HB	JC8050 (JC8118) SPNW SPMT-PM	~150	1.5★	~32	1,020	7,340	~150	1.5★	~32	1,020	9,180	~150	1.5★	~44	810	7,290
		200	1.2★	~32	1,020	7,340	200	1.2★	~32	1,020	9,180	200	1.5★	~44	810	7,290
		250	0.8	~32	890	5,340	250	0.8	~32	890	6,680	250	1.2★	~44	710	5,330
		300	0.6	~32	830	4,980	300	0.6	~32	830	6,230	300	1	~44	660	4,950
		350	0.5	~32	830	4,650	350	0.5	~32	830	5,810	350	0.5	~44	660	4,620
Mold steel (HPM7, PX5, P20) 30-36 HRC	JC8050 (JC8118) SPNW SPMT-PM	~150	1.5★	~32	1,020	7,340	~150	1.5★	~32	1,020	9,180	~150	1.5★	~44	810	7,290
		200	1.2★	~32	1,020	7,340	200	1.2★	~32	1,020	9,180	200	1.5★	~44	810	7,290
		250	0.8	~32	890	5,340	250	0.8	~32	890	6,680	250	1.2★	~44	710	5,330
		300	0.6	~32	830	4,980	300	0.6	~32	830	6,230	300	1	~44	660	4,950
		350	0.5	~32	830	4,650	350	0.5	~32	830	5,810	350	0.5	~44	660	4,620
Mold steel (NAK80, HPM1, P21) 38-43HRC	JC8118 (JC8050) SPNW SPMT-PM	~150	1.2★	~32	700	4,200	~150	1.2★	~32	700	5,250	~150	1.2★	~44	560	4,200
		200	1	~32	700	4,200	200	1	~32	700	5,250	200	1.2★	~44	560	4,200
		250	0.7	~32	640	3,840	250	0.7	~32	640	4,800	250	1	~44	510	3,830
		300	0.6	~32	510	2,860	300	0.6	~32	510	3,570	300	0.5	~44	400	2,800
		350	-	-	-	-	350	-	-	-	-	350	-	-	-	-
Hardened die steel (SKD61, DAC, DHA) 42-52HRC	JC8118 SPNW	~150	1	~32	640	3,580	~150	1	~32	640	4,480	~150	1	~44	510	3,570
		200	0.8	~32	640	3,330	200	0.8	~32	640	4,160	200	0.8	~44	510	3,320
		250	0.6	~32	640	3,070	250	0.6	~32	640	3,840	250	0.6	~44	510	3,060
		300	-	-	-	-	300	-	-	-	-	300	-	-	-	-
		350	-	-	-	-	350	-	-	-	-	350	-	-	-	-
Grey & Nodular cast iron (FC, FCD) below 300HB	JC8118 SPNW SPMT-PM	~150	1.5★	~32	1,150	8,280	~150	1.5★	~32	1,150	10,350	~150	1.5★	~44	910	8,190
		200	1.5★	~32	1,150	8,280	200	1.5★	~32	1,150	10,350	200	1.5★	~44	910	8,190
		250	1.2★	~32	1,150	6,900	250	1.2★	~32	1,150	8,630	250	1.2★	~44	910	6,830
		300	0.8	~32	1,020	6,120	300	0.8	~32	1,020	7,650	300	0.8	~44	810	6,080
		350	0.5	~32	1,020	6,120	350	0.5	~32	1,020	7,650	350	0.5	~44	810	6,080
Stainless steel (SUS304) below 250HB	JC7550 SPMT-SM SPET-SM	~150	1	~32	950	4,940	~150	1	~32	950	6,180	~150	1	~44	760	5,320
		200	1	~32	950	4,940	200	1	~32	950	6,180	200	1	~44	760	4,940
		250	0.8	~32	830	3,980	250	0.8	~32	830	4,980	250	0.8	~44	660	3,960
		300	0.6	~32	760	3,040	300	0.6	~32	760	3,800	300	0.6	~44	610	3,050
		350	0.4	~32	640	2,560	350	0.4	~32	640	3,200	350	0.5	~44	510	2,550
Titanium alloy (Ti-6Al-4V)	DS150 SPMT-SM SPET-SM	~150	1	~32	380	910	~150	1	~32	380	1,140	~150	1	~44	300	900
		200	0.8	~32	380	910	200	0.8	~32	380	1,140	200	0.8	~44	300	900
		250	0.6	~32	380	760	250	0.6	~32	380	950	250	0.6	~44	300	750
		300	0.4	~32	380	610	300	0.4	~32	380	760	300	0.4	~44	300	600
		350	-	-	-	-	350	-	-	-	-	350	-	-	-	-

Note

1. Please adjust cutting conditions according to machine rigidity or work rigidity. (the above table is guide for cutting on a #50 BT machine.)
2. In case of chatter occurring, recommended to reduce a_p or rpm and keep feed per tooth.
3. a_p should be reduced when using on low rigidity machine.
4. Use air blow.

★: a_p ≤ 1.0 when using SPMT10/SPET10 insert.

SKS-GII

SKG/MSG Type

■ Recommended cutting conditions

● SKG10 Type

Material	Grade	Tool dia.(mm)									
		63/66					80				
		6N					6N				
		ℓ (mm)	ap (mm)	ae (mm)	n (min ⁻¹)	Vf (mm/min)	ℓ (mm)	ap (mm)	ae (mm)	n (min ⁻¹)	Vf (mm/min)
Carbon steel (S50C, S55C) below 250HB	JC8050 (JC8118) SPNW SPMT-PM	~150	1.5★	~44	810	8,750	~150	1.5★	~60	640	6,910
		200	1.5★	~44	810	8,750	200	1.5★	~60	640	6,910
		250	1.2★	~42	710	6,390	250	1.2★	~55	560	5,040
		300	1	~42	660	5,940	300	1	~55	520	4,680
		350	0.5	~42	660	5,540	350	0.5	~55	520	4,370
Tool & die steel (SKD61, SKD11) below 255HB	JC8050 (JC8118) SPNW SPMT-PM	~150	1.5★	~44	810	8,750	~150	1.5★	~60	640	6,910
		200	1.5★	~44	810	8,750	200	1.5★	~60	640	6,910
		250	1.2★	~42	710	6,390	250	1.2★	~55	560	5,040
		300	1	~42	660	5,940	300	1	~55	520	4,680
		350	0.5	~42	660	5,540	350	0.5	~55	520	4,370
Mold steel (HPM7, PX5, P20) 30-36 HRC	JC8050 (JC8118) SPNW SPMT-PM	~150	1.5★	~44	810	8,750	~150	1.5★	~60	640	6,910
		200	1.5★	~44	810	8,750	200	1.5★	~60	640	6,910
		250	1.2★	~42	710	6,390	250	1.2★	~55	560	5,040
		300	1	~42	660	5,940	300	1	~55	520	4,680
		350	0.5	~42	660	5,540	350	0.5	~55	520	4,370
Mold steel (NAK80, HPM1, P21) 38-43HRC	JC8118 (JC8050) SPNW SPMT-PM	~150	1.2★	~44	560	5,040	~150	1.2★	~60	440	3,960
		200	1.2★	~44	560	5,040	200	1.2★	~60	440	3,960
		250	1	~42	510	4,590	250	1	~55	400	3,600
		300	0.5	~42	400	3,360	300	0.5	~55	320	2,690
		350	-	-	-	-	350	-	-	-	-
Hardened die steel (SKD61, DAC, DHA) 42-52HRC	JC8118 SPNW	~150	1	~44	510	4,280	~150	1	~60	400	3,360
		200	0.8	~44	510	3,980	200	0.8	~60	400	3,120
		250	0.6	~42	510	3,670	250	0.6	~55	400	2,880
		300	-	-	-	-	300	-	-	-	-
		350	-	-	-	-	350	-	-	-	-
Grey & Nodular cast iron (FC, FCD) below 300HB	JC8118 SPNW SPMT-PM	~150	1.5★	~44	910	9,830	~150	1.5★	~60	720	7,780
		200	1.5★	~44	910	9,830	200	1.5★	~60	720	7,780
		250	1.2★	~42	910	8,190	250	1.2★	~55	720	6,480
		300	0.8	~42	810	7,290	300	0.8	~55	640	5,760
		350	0.5	~42	810	7,290	350	0.5	~55	640	5,760
Stainless steel (SUS304) below 250HB	JC7550 SPMT-SM SPET-SM	~150	1	~44	760	6,380	~150	1	~60	600	5,040
		200	1	~44	760	5,930	200	1	~60	600	4,680
		250	0.8	~42	660	4,750	250	0.8	~55	520	3,740
		300	0.6	~42	610	3,660	300	0.6	~55	480	2,880
		350	0.5	~42	510	3,060	350	0.5	~55	400	2,400
Titanium alloy (Ti-6Al-4V)	DS150 SPMT-SM SPET-SM	~150	1	~44	300	1,080	~150	1	~60	240	860
		200	0.8	~44	300	1,080	200	0.8	~60	240	860
		250	0.6	~42	300	900	250	0.6	~55	240	720
		300	0.4	~42	300	720	300	0.4	~55	240	580
		350	-	-	-	-	350	-	-	-	-

Note

1. Please adjust cutting conditions according to machine rigidity or work rigidity. (the above table is guide for cutting on a #50 BT machine.)
2. In case of chatter occurring, recommended to reduce ap or rpm and keep feed per tooth.
3. ap should be reduced when using on low rigidity machine.
4. Use air blow.

★: ap ≤ 1.0 when using SPMT10/SPET10 insert.

SKS-GII**SKG/MSG Type**

■ Recommended cutting conditions

● SKG14 Type

		SKG/MSG Type														
		50/52					63					66				
		4N					4N					5N				
		ℓ (mm)	ap (mm)	ae (mm)	n (min ⁻¹)	Vf (mm/min)	ℓ (mm)	ap (mm)	ae (mm)	n (min ⁻¹)	Vf (mm/min)	ℓ (mm)	ap (mm)	ae (mm)	n (min ⁻¹)	Vf (mm/min)
Carbon steel (S50C, S55C) below 250HB	JC8050 (JC8118) SPNW SPMT-PM	~150	2★	~28	890	6,410	~150	2★	~40	710	5,110	~150	2★	~44	680	6,120
		200	1.8	~28	890	6,410	200	1.8	~40	710	5,110	200	1.8	~44	680	6,120
		250	1.5	~28	830	4,980	250	1.5	~40	660	3,960	250	1.5	~44	630	4,730
		300	0.8	~28	760	4,560	300	0.8	~40	610	3,660	300	0.8	~44	580	4,350
		350	0.6	~28	640	3,580	350	0.6	~40	510	2,860	350	0.6	~44	480	3,360
Tool & die steel (SKD61, SKD11) below 255HB	JC8050 (JC8118) SPNW SPMT-PM	~150	2★	~28	890	6,410	~150	2★	~40	710	5,110	~150	2★	~44	680	6,120
		200	1.8	~28	890	6,410	200	1.8	~40	710	5,110	200	1.8	~44	680	6,120
		250	1.5	~28	830	4,980	250	1.5	~40	660	3,960	250	1.5	~44	630	4,730
		300	0.8	~28	760	4,560	300	0.8	~40	610	3,660	300	0.8	~44	580	4,350
		350	0.6	~28	640	3,580	350	0.6	~40	510	2,860	350	0.6	~44	480	3,360
Mold steel (HPM7, PX5, P20) 30-36 HRC	JC8050 (JC8118) SPNW SPMT-PM	~150	2★	~28	890	6,410	~150	2★	~40	710	5,110	~150	2★	~44	680	6,120
		200	1.8	~28	890	6,410	200	1.8	~40	710	5,110	200	1.8	~44	680	6,120
		250	1.5	~28	830	4,980	250	1.5	~40	660	3,960	250	1.5	~44	630	4,730
		300	0.8	~28	760	4,560	300	0.8	~40	610	3,660	300	0.8	~44	580	4,350
		350	0.6	~28	640	3,580	350	0.6	~40	510	2,860	350	0.6	~44	480	3,360
Mold steel (NAK80, HPM1, P21) 38-43HRC	JC8118 (JC8050) SPNW SPMT-PM	~150	1.6	~28	640	3,840	~150	1.6	~40	510	3,060	~150	1.6	~44	480	3,600
		200	1.4	~28	640	3,840	200	1.4	~40	510	3,060	200	1.4	~44	480	3,600
		250	1.2	~28	640	3,840	250	1.2	~40	510	3,060	250	1.2	~44	480	3,600
		300	0.7	~28	510	2,860	300	0.7	~40	400	2,240	300	0.7	~44	390	2,730
		350	-	-	-	-	350	-	-	-	-	350	-	-	-	-
Hardened die steel (SKD61, DAC, DHA) 42-52HRC	JC8118 SPNW	~150	1	~28	570	2,740	~150	1	~40	450	2,160	~150	1	~44	430	2,580
		200	1	~28	570	2,280	200	1	~40	450	1,800	200	1	~44	430	2,150
		250	0.8	~28	570	1,820	250	0.8	~40	450	1,440	250	0.8	~44	430	1,720
		300	0.5	~28	450	1,260	300	0.5	~40	350	980	300	0.5	~44	340	1,190
		350	-	-	-	-	350	-	-	-	-	350	-	-	-	-
Grey & Nodular cast iron (FC, FCD) below 300HB	JC8118 SPNW SPMT-PM	~150	2★	~28	1,150	8,280	~150	2★	~40	910	6,550	~150	2★	~44	870	7,830
		200	1.8	~28	1,150	8,280	200	1.8	~40	910	6,550	200	1.8	~44	870	7,830
		250	1.5	~28	1,150	6,900	250	1.5	~40	910	5,460	250	1.5	~44	870	6,530
		300	0.8	~28	1,020	6,120	300	0.8	~40	810	4,860	300	0.8	~44	770	5,780
		350	0.6	~28	1,020	5,710	350	0.6	~40	810	4,540	350	0.6	~44	770	5,390
Stainless steel (SUS304) below 250HB	JC7550 SPMT-SM	~150	1.3	~28	950	4,940	~150	1.3	~40	760	4,260	~150	1.3	~44	760	5,320
		200	1.3	~28	950	4,940	200	1.3	~40	760	3,950	200	1.3	~44	760	4,940
		250	1.1	~28	830	3,980	250	1.1	~40	660	3,170	250	1.1	~44	660	3,960
		300	0.9	~28	760	3,040	300	0.9	~40	610	2,440	300	0.9	~44	610	3,050
		350	0.7	~28	640	2,560	350	0.7	~40	510	2,040	350	0.7	~44	510	2,550
Titanium alloy (Ti-6Al-4V)	DS150 SPMT-SM	~150	1.3	~28	380	910	~150	1.3	~40	300	720	~150	1.3	~44	300	900
		200	1.1	~28	380	910	200	1.1	~40	300	720	200	1.1	~44	300	900
		250	0.9	~28	380	760	250	0.9	~40	300	600	250	0.9	~44	300	750
		300	0.7	~28	380	610	300	0.7	~40	300	480	300	0.7	~44	300	600
		350	-	-	-	-	350	-	-	-	-	350	-	-	-	-

Note

1. Please adjust cutting conditions according to machine rigidity or work rigidity. (the above table is guide for cutting on a #50 BT machine.)
2. In case of chatter occurring, recommended to reduce ap or rpm and keep feed per tooth.
3. ap should be reduced when using on low rigidity machine.
4. Use air blow.

★: ap ≤ 1.8 when using SPMT14 insert.

SKS-GII

SKG/MSG Type

■ Recommended cutting conditions

● SKG14 Type

Material	Grade	Tool dia.(mm)														
		80					100					125				
		5N					6N					6N				
		ℓ (mm)	ap (mm)	ae (mm)	n (min ⁻¹)	Vf (mm/min)	ℓ (mm)	ap (mm)	ae (mm)	n (min ⁻¹)	Vf (mm/min)	ℓ (mm)	ap (mm)	ae (mm)	n (min ⁻¹)	Vf (mm/min)
Carbon steel (S50C, S55C) below 250HB	JC8050 (JC8118) SPNW SPMT-PM	~150	2★	~56	600	5,400	~150	2★	~70	480	5,180	~150	2★	~87	380	4,100
		200	1.8	~56	600	5,400	200	1.8	~70	480	5,180	200	1.8	~87	380	4,100
		250	1.5	~56	560	4,200	250	1.5	~70	450	4,050	250	1.5	~87	360	3,240
		300	0.8	~56	520	3,900	300	0.8	~70	410	3,690	300	0.8	~87	330	2,970
Tool & die steel (SKD61, SKD11) below 255HB	JC8050 (JC8118) SPNW SPMT-PM	~150	2★	~56	600	5,400	~150	2★	~70	480	5,180	~150	2★	~87	380	4,100
		200	1.8	~56	600	5,400	200	1.8	~70	480	5,180	200	1.8	~87	380	4,100
		250	1.5	~56	560	4,200	250	1.5	~70	450	4,050	250	1.5	~87	360	3,240
		300	0.8	~56	520	3,900	300	0.8	~70	410	3,690	300	0.8	~87	330	2,970
Mold steel (HPM7, PX5, P20) 30-36 HRC	JC8050 (JC8118) SPNW SPMT-PM	~150	2★	~56	600	5,400	~150	2★	~70	480	5,180	~150	2★	~87	380	4,100
		200	1.8	~56	600	5,400	200	1.8	~70	480	5,180	200	1.8	~87	380	4,100
		250	1.5	~56	560	4,200	250	1.5	~70	450	4,050	250	1.5	~87	360	3,240
		300	0.8	~56	520	3,900	300	0.8	~70	410	3,690	300	0.8	~87	330	2,970
Mold steel (NAK80, HPM1, P21) 38-43HRC	JC8118 (JC8050) SPNW SPMT-PM	~150	1.6	~56	400	3,000	~150	1.6	~70	320	2,880	~150	1.6	~87	250	2,250
		200	1.4	~56	400	3,000	200	1.4	~70	320	2,880	200	1.4	~87	250	2,250
		250	1.2	~56	400	3,000	250	1.2	~70	320	2,880	250	1.2	~87	250	2,250
		300	0.7	~56	320	2,240	300	0.7	~70	250	2,100	300	0.7	~87	200	1,680
Hardened die steel (SKD61, DAC, DHA) 42-52HRC	JC8118 SPNW	~150	1	~56	360	2,160	~150	1	~70	290	2,090	~150	1	~87	230	1,660
		200	1	~56	360	1,800	200	1	~70	290	1,740	200	1	~87	230	1,380
		250	0.8	~52	360	1,440	250	0.8	~60	290	1,390	250	0.8	~75	230	1,100
		300	0.5	~52	280	980	300	0.5	~60	220	920	300	0.5	~75	180	760
Gery & Nodular cast iron (FC, FCD) below 300HB	JC8118 SPNW SPMT-PM	~150	2★	~56	720	6,480	~150	2★	~70	570	6,160	~150	2★	~87	460	4,970
		200	1.8	~56	720	6,480	200	1.8	~70	570	6,160	200	1.8	~87	460	4,970
		250	1.5	~56	720	5,400	250	1.5	~70	570	5,130	250	1.5	~87	460	4,140
		300	0.8	~56	640	4,800	300	0.8	~70	510	4,590	300	0.8	~87	410	3,690
Stainless steel (SUS304) below 250HB	JC7550 SPMT-SM	~150	1.5	~56	600	4,200	~150	1.5	~70	480	4,030	~150	1.5	~87	380	3,190
		200	1.5	~56	600	3,900	200	1.5	~70	480	3,740	200	1.5	~87	380	2,960
		250	1.3	~52	520	3,120	250	1.3	~60	410	2,950	250	1.3	~75	330	2,380
		300	1.1	~52	480	2,400	300	1.1	~60	380	2,280	300	1.1	~75	310	1,860
Titanium alloy (Ti-6Al-4V)	DS150 SPMT-SM	~150	1.3	~56	240	720	~150	1.3	~70	190	680	~150	1.3	~87	150	540
		200	1.1	~56	240	720	200	1.1	~70	190	680	200	1.1	~87	150	540
		250	0.9	~52	240	600	250	0.9	~60	190	570	250	0.9	~75	150	450
		300	0.7	~52	240	480	300	0.7	~60	190	460	300	0.7	~75	150	360
		350	-	-	-	-	350	-	-	-	-	350	-	-	-	-

Note

1. Please adjust cutting conditions according to machine rigidity or work rigidity. (the above table is guide for cutting on a #50 BT machine.)
2. In case of chatter occurring, recommended to reduce ap or rpm and keep feed per tooth.
3. ap should be reduced when using on low rigidity machine.
4. Use air blow.

★: ap ≤ 1.8 when using SPMT14 insert

SKS-GII**SKG/MSG Type**

■ Recommended cutting conditions

● SKG14 Type

Material	Grade	Tool dia.(mm)				
		160				
		7N				
		ℓ (mm)	a _p (mm)	a _e (mm)	n (min ⁻¹)	V _f (mm/min)
Carbon steel (S50C, S55C) below 250HB	JC8050 (JC8118) SPNW SPMT-PM	~150	2★	~112	300	3,780
		200	1.8	~112	300	3,780
		250	1.5	~112	280	2,940
		300	0.8	~112	260	2,730
		350	0.6	~112	220	2,160
Tool & die steel (SKD61, SKD11) below 255HB	JC8050 (JC8118) SPNW SPMT-PM	~150	2★	~112	300	3,780
		200	1.8	~112	300	3,780
		250	1.5	~112	280	2,940
		300	0.8	~112	260	2,730
		350	0.6	~112	220	2,160
Mold steel (HPM7, PX5, P20) 30-36 HRC	JC8050 (JC8118) SPNW SPMT-PM	~150	2★	~112	300	3,780
		200	1.8	~112	300	3,780
		250	1.5	~112	280	2,940
		300	0.8	~112	260	2,730
		350	0.6	~112	220	2,160
Mold steel (NAK80, HPM1, P21) 38-43HRC	JC8118 (JC8050) SPNW SPMT-PM	~150	1.6	~112	200	2,100
		200	1.4	~112	200	2,100
		250	1.2	~112	200	2,100
		300	0.7	~112	160	1,570
		350	-	-	-	-
Hardened die steel (SKD61, DAC, DHA) 42-52HRC	JC8118 SPNW	~150	1	~112	180	1,510
		200	1	~112	180	1,260
		250	0.8	~100	180	1,010
		300	0.5	~100	140	690
		350	-	-	-	-
Grey & Nodular cast iron (FC, FCD) below 300HB	JC8118 SPNW SPMT-PM	~150	2★	~112	360	4,540
		200	1.8	~112	360	4,540
		250	1.5	~112	360	3,780
		300	0.8	~112	320	3,360
		350	0.6	~112	320	3,140
Stainless steel (SUS304) below 250HB	JC7550 SPMT-SM	~150	1.5	~112	300	2,940
		200	1.5	~112	300	2,730
		250	1.3	~100	260	2,180
		300	1.1	~100	240	1,680
		350	0.9	~100	200	1,400
Titanium alloy (Ti-6Al-4V)	DS150 SPMT-SM	~150	1.3	~112	120	500
		200	1.1	~112	120	500
		250	0.9	~100	120	420
		300	0.7	~100	120	340
		350	-	-	-	-

Note

1. Please adjust cutting conditions according to machine rigidity or work rigidity. (the above table is guide for cutting on a #50 BT machine.)
2. In case of chatter occurring, recommended to reduce a_p or rpm and keep feed per tooth.
3. a_p should be reduced when using on low rigidity machine.
4. Use air blow.

★: a_p ≤ 1.8 when using SPMT14 insert

SKS-GII 09

SKG09/MSG09 Type

SKS-GII

Type 09

Specifically designed for high efficiency machining of difficult to cut materials

Feature 1

Multi-edge design enables high efficiency machining. Achieved Max ap=0.9 mm even if difficult-to-cut materials such as titanium alloy, stainless steel & heat-resistant alloy

● Tool dia. $\varnothing 50$



Feature 2

The optimised cutting edge design provides the sharpness and low cutting resistance that is ideal for difficult-to-cut materials.

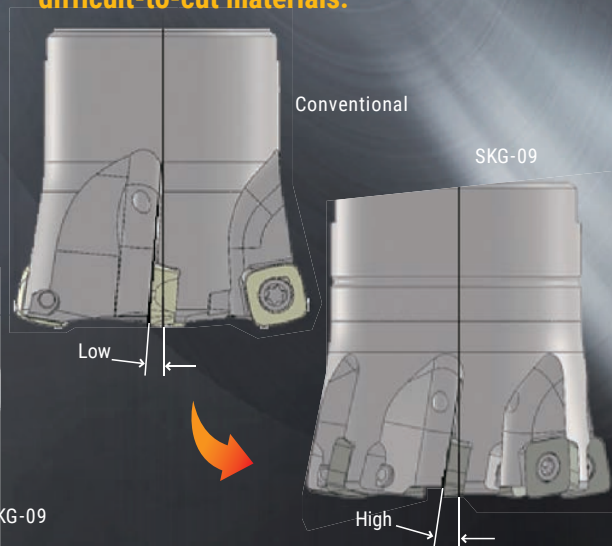

SKS-GII 09

SKG09/MSG09 Type

Feature 3

**Economical 4 cutting edges
Precise ground insert provides run out accuracy and longer tool life.**



Line up

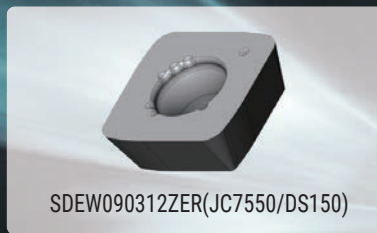
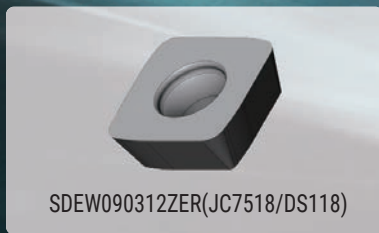
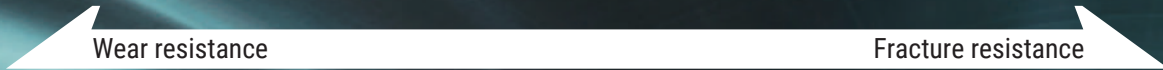

Insert	Titanium alloy	Inconel	SUS630	SUS316
SDEW090312ZER (JC7518)	●	●	●	
SDEW090312ZER (JC7550)	■			●■
SDEW090312ZER (DS118)	●	●		
SDEW090312ZER (DS150)	■			
SDET090312ZDER-SM (JC7550)		■	■	
SDET090312ZDER-SM (DS150)		■	■	

●: stable machining ■: unstable machining

SKS-GII 09

SKG09/MSG09 Type

■ **SKG09 Facemill Type**



Through coolant hole

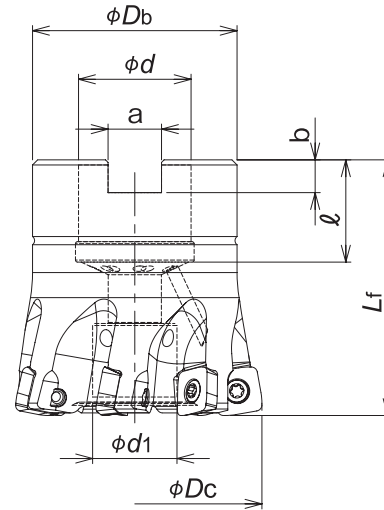

Cat.No.	Stock	No. of inserts	Dimensions (mm)								Arbor set bolt	Weight (kg)	Inserts
			φDc	Lf	φDb	φd	φd1	a	b	ℓ			
SKG-5040R-09-16	●	5	40	40	37	16	13.5	8.4	5.6	18	M8	0.21	SDEW090312ZER; SDET090312ZDER-SM
SKG-7050R-09-22	●	7	50	50	40	22	16.5	10.4	6.3	20	M10	0.35	
SKG-7052R-09-22	●		52		M10						0.37		
SKG-8063R-09-22	●	8	63	48	17	20	12.4	7	22	M10	0.58		
SKG-8066R-09-27	●		66	50	27					20	M12X1.75X30★	0.60	
SKG-9080R-09-27	●	9	80	60	27	20	12.4	7	22	M12X1.75X30★	0.97		

Screw	Torque(N.m)	Wrench
DSW-307H	2.1	A-10

SKS-GII 09 **SKG09/MSG09 Type**

■ **SKG09 Endmill Type**

Through coolant hole

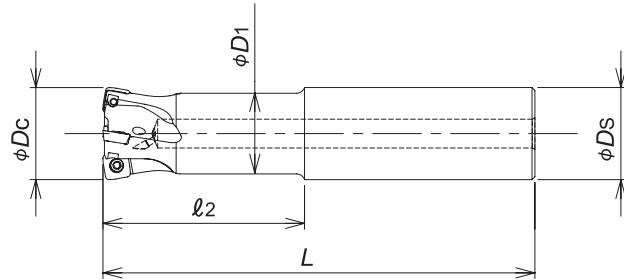
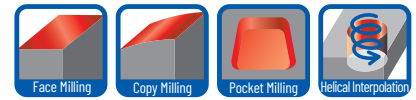

Cat.No.	Stock	No. of inserts	Dimensions (mm)					Inserts
			φDc	ℓ2	L	φD1	φDs	
SKG-3025-60-09-S25	●	3	25	60	140	23	25	SDEW090312ZER; SDET090312ZDER-SM
SKG-3025-100-09-S25	●			100	180			
SKG-4032-70-09-S32	●	4	32	70	150	28	32	
SKG-4032-120-09-S32	●			120	200			
SKG-5035-70-09-S32	●	5	35	70	150	31	32	
SKG-5035-120-09-S32	●			120	200			

Screw	Torque(N.m)	Wrench
DSW-307H	2.1	A-10

SKS-GII 09 **SKG09/MSG09 Type**

■ **MSG09 Modular Head Type**

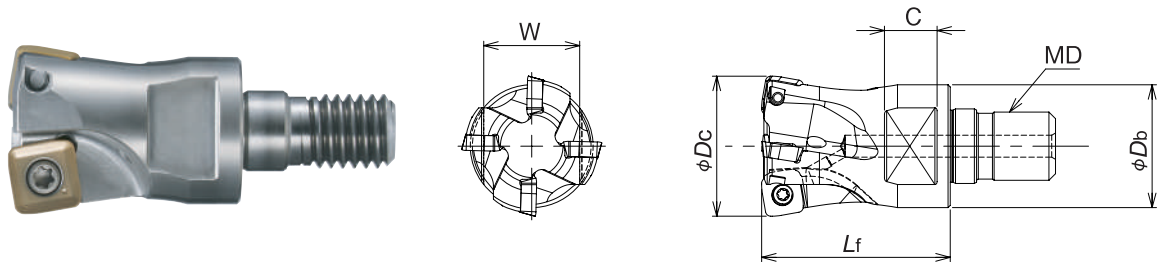
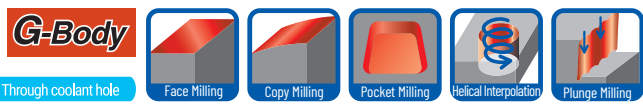

Cat.No.	Stock	No. of inserts	Dimensions (mm)						Inserts	Parts
			ϕD_c	L_f	ϕD_b	MD	C	W		
MSG-2020-09-M10	●	2	20	30	19	M10	9	14	SDEW090312ZER; SDET090312ZDER-SM	DSW-306H
MSG-2022-09-M10	●		22			M10				
MSG-3025-09-M12	●	3	25	35	23	M12	11	19		DSW-307H
MSG-4028-09-M12	●	4	28		23.6	M12				
MSG-4032-09-M16	●	4	32	43	28	M16	12	22		
MSG-5035-09-M16	●		35		29	M16				
MSG-5040-09-M16	●		40		32	M16				
MSG-5042-09-M16	●	5	42	43	32	M16	14	26		
					M16					

Screw	Torque(N.m)	Wrench
DSW-306H	1.8	A-10
DSW-307H	2.1	A-10

SKS-GII 09 **SKG09/MSG09 Type**

■ **SKG/MSG09 Type Insert**

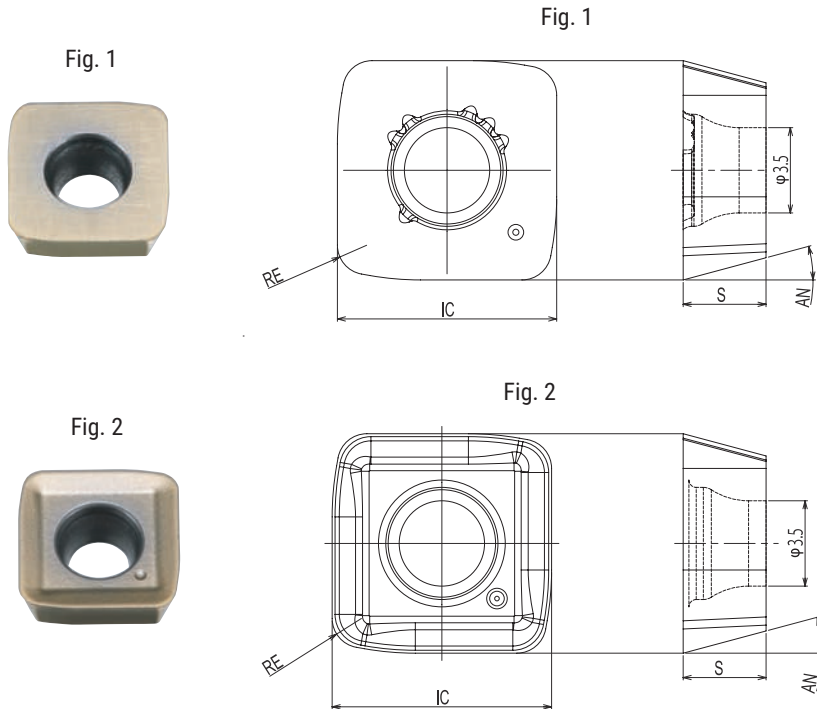

Cat.No.	Tolerance	PVD Coating				Dimensions (mm)				Fig.
		DS150	JC7550	JC8050	JC8118	RE	IC	S	AN	
SDEW090312ZER	E	●	●	●	●	1.2	9	3.4	15°	1
SDET090312ZDER-SM			●		●					2

GRADE MARKING

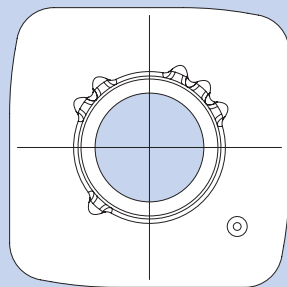

JC7550/DS150

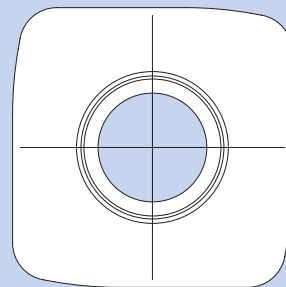

JC7518/DS118

SKS-GII 09

SKG09/MSG09 Type

Definition of corner shape for programming

■ SDET090312ZDER-SM
SDEW090312ZER

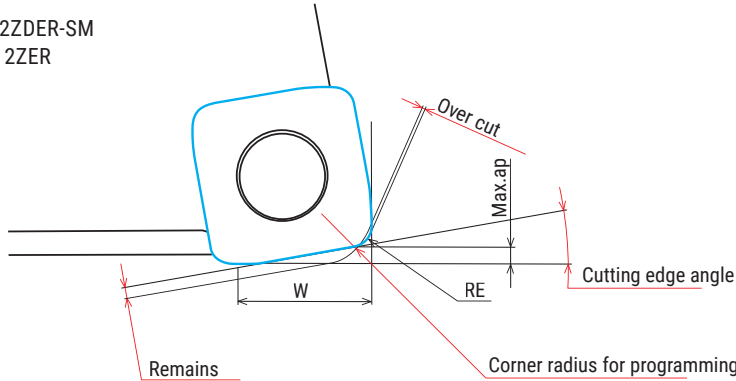

Corner radius for programming	Remains	Over cut	Max.ap	W	Cutting edge angle
1.5	0.81	0	0.9	7.1	10°
2 (Standard)	0.73	0			
2.5	0.65	0.08			

Recommended Data for Profile Milling

Ramping

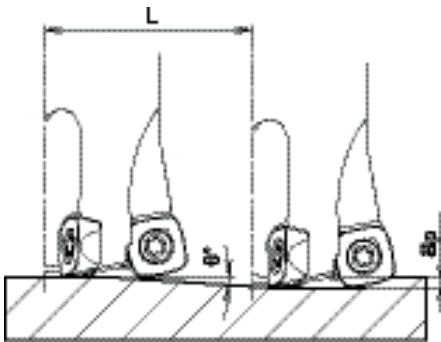

Helical interpolation

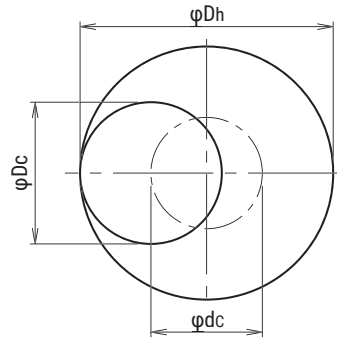

● Calculation of tool pass dia.

$$\phi_{dc} = \phi_{Dh} - \phi_{Dc}$$

Tool pass dia. Bore dia. Tool dia.

● Depth of cut per one circuit should not exceed max. depth of cut Ap

● Down cutting is recommended, tool pass rotation should be counterclockwise

● In case of ramping and helical interpolation, apply 70% or less feed (Vf) from standard cutting condition table

Cat.No.	Tool dia.	Effective cutting dia.	Max.depth of cut : ap	Ramping		Helical interpolation	
				Max.ramping angle θ	Total cutting length at Max.ap : L(mm)	Min.Bore dia. (mm)	Max.Bore dia. (mm)
MSG-2020-09-M10	20	5.6	0.9	1°	51.6	27	38
MSG-2022-09-M10	22	7.7	0.9	1°	51.6	31	42
MSG-3025-09-M12	25	10.7	0.9	1°	51.6	37	48
MSG-4028-09-M12	28	13.7	0.9	1°	51.6	43	54
MSG-4032-09-M16	32	17.6	0.9	1°	51.6	51	62
MSG-5035-09-M16	35	20.6	0.9	1°	51.6	57	68
MSG-5040-09-M16	40	25.7	0.9	1°	51.6	67	78
MSG-5042-09-M16	42	27.7	0.9	1°	51.6	71	82
SKG-3025-60-09-S25	25	10.7	0.9	1°	51.6	37	48
SKG-3025-100-09-S25	25	10.7	0.9	1°	51.6	37	48
SKG-4032-70-09-S32	32	17.6	0.9	1°	51.6	51	62
SKG-4032-120-09-S32	32	17.6	0.9	1°	51.6	51	62
SKG-5035-70-09-S32	35	20.6	0.9	1°	51.6	57	68
SKG-5035-120-09-S32	35	20.6	0.9	1°	51.6	57	68
SKG-5040R-09-16	40	25.7	0.9	1°	51.6	67	78
SKG-7050R-09-22	50	35.6	0.9	1°	51.6	87	98
SKG-7052R-09-22	52	37.6	0.9	1°	51.6	91	102
SKG-8063R-09-22	63	48.7	0.9	0°45'	68.8	113	124
SKG-8066R-09-27	66	51.7	0.9	0°45'	68.8	119	130
SKG-9080R-09-27	80	65.7	0.9	0°30'	103.1	147	158

SKS-GII 09**SKG09/MSG09 Type**

■ Recommended cutting conditions

● MSG09 Type + MSN shank

Material	Cat.No	Grade	Tool dia.(mm)														
			20					22					25				
			2N					2N					3N				
			ℓ (mm)	ap (mm)	ae (mm)	n (min ⁻¹)	Vf (mm/min)	ℓ (mm)	ap (mm)	ae (mm)	n (min ⁻¹)	Vf (mm/min)	ℓ (mm)	ap (mm)	ae (mm)	n (min ⁻¹)	Vf (mm/min)
Austenitic stainless steel (SUS304, 316, 317) 17Cr	SDEW 090312 ZER (SDET 090312 ZDER-SM)	JC7550	~60	0.8	~5	2,390	4,780	~60	0.8	~6	2,170	4,340	~75	0.8	~9	1,910	5,730
			100	0.6	~5	2,390	4,780	100	0.6	~6	2,170	4,340	125	0.6	~9	1,910	5,730
			140	0.6	~5	1,990	3,180	140	0.6	~6	1,810	2,900	175	0.6	~9	1,720	4,390
Ferritic and martensitic stainless steel (SUS403 420J2, 430) 17Cr	SDEW 090312 ZER (SDET 090312 ZDER-SM)	JC7550	~60	0.8	~5	3,020	6,040	~60	0.8	~6	2,750	5,500	~75	0.8	~9	2,420	7,260
			100	0.6	~5	3,020	6,040	100	0.6	~6	2,750	5,500	125	0.6	~9	2,420	7,260
			140	0.6	~5	2,470	3,950	140	0.6	~6	2,240	3,580	175	0.6	~9	2,160	5,510
Duplex stainless steel	SDEW 090312 ZER	JC7518 (JC7550)	~60	0.8	~5	1,590	950	~60	0.8	~6	1,450	870	~75	0.8	~9	1,270	1,140
			100	0.6	~5	1,590	950	100	0.6	~6	1,450	870	125	0.6	~9	1,270	1,140
			140	0.6	~5	1,350	680	140	0.6	~6	1,230	620	175	0.6	~9	1,150	860
Titanium alloy (Ti-6Al-4V) 35-43HRC	SDEW 090312 ZER	DS150 (DS118)	~60	0.8	~5	950	1,140	~60	0.8	~6	870	1,040	~75	0.8	~9	760	1,370
			100	0.6	~5	950	1,140	100	0.6	~6	870	1,040	125	0.6	~9	760	1,370
			140	0.6	~5	800	800	140	0.6	~6	720	720	175	0.6	~9	700	1,050
Heat resistant alloy (INCO718) 35-43HRC	SDEW 090312 ZER	DS118 (DS150)	~60	0.5	~5	480	580	~60	0.5	~6	430	520	~75	0.5	~9	380	680
			100	0.4	~5	480	580	100	0.4	~6	430	520	125	0.4	~9	380	680
			140	0.4	~5	400	400	140	0.4	~6	360	360	175	0.4	~9	320	480

Note

1. Please adjust cutting conditions according to machine rigidity or work rigidity. (the above table is guide for cutting on a #50 BT machine.)
2. In case of chatter occurring, recommended to reduce ap or rpm and keep feed per tooth.
3. ap should be reduced when using on low rigidity machine.
4. Use air blow.
5. Wet cutting is recommended for machining super duplex , titanium alloy and heat resistant alloy.

SKS-GII 09

SKG09/MSG09 Type

■ Recommended cutting conditions

● MSG09 Type + MSN shank

Material	Cat.No	Grade	Tool dia.(mm)														
			28					32					35				
			4N					4N					5N				
			ℓ (mm)	ap (mm)	ae (mm)	n (min ⁻¹)	Vf (mm/min)	ℓ (mm)	ap (mm)	ae (mm)	n (min ⁻¹)	Vf (mm/min)	ℓ (mm)	ap (mm)	ae (mm)	n (min ⁻¹)	Vf (mm/min)
Austenitic stainless steel (SUS304, 316, 317) 17Cr	SDEW 090312 ZER (SDET 090312 ZDER-SM)	JC7550	~75	0.8	~12	1,710	6,840	~90	0.8	~15	1,490	5,960	~90	0.8	~18	1,360	6,800
			125	0.6	~12	1,710	6,840	150	0.6	~15	1,490	5,960	150	0.6	~18	1,360	6,800
			175	0.6	~12	1,530	5,200	210	0.6	~15	1,240	3,970	210	0.6	~18	1,140	4,560
Ferritic and martensitic stainless steel (SUS403 420J2, 430) 17Cr	SDEW 090312 ZER (SDET 090312 ZDER-SM)	JC7550	~75	0.8	~12	2,160	8,640	~90	0.8	~15	1,890	7,560	~90	0.8	~18	1,730	8,650
			125	0.6	~12	2,160	8,640	150	0.6	~15	1,890	7,560	150	0.6	~18	1,730	8,650
			175	0.6	~12	1,930	6,560	210	0.6	~15	1,540	4,930	210	0.6	~18	1,410	5,640
Duplex stainless steel	SDEW 090312 ZER	JC7518 (JC7550)	~75	0.8	~12	1,140	1,370	~90	0.8	~15	990	1,190	~90	0.8	~18	910	1,370
			125	0.6	~12	1,140	1,370	150	0.6	~15	990	1,190	150	0.6	~18	910	1,370
			175	0.6	~12	1,020	1,020	210	0.6	~15	850	850	210	0.6	~18	770	960
Titanium alloy (Ti-6Al-4V) 35-43HRC	SDEW 090312 ZER	DS150 (DS118)	~75	0.8	~12	680	1,630	~90	0.8	~15	600	1,440	~90	0.8	~18	550	1,650
			125	0.6	~12	680	1,630	150	0.6	~15	600	1,440	150	0.6	~18	550	1,650
			175	0.6	~12	630	1,260	210	0.6	~15	500	1,000	210	0.6	~18	450	1,130
Heat resistant alloy (INCO718) 35-43HRC	SDEW 090312 ZER	DS118 (DS150)	~75	0.5	~12	340	820	~90	0.5	~15	300	720	~90	0.5	~18	270	810
			125	0.4	~12	340	820	150	0.4	~15	300	720	150	0.4	~18	270	810
			175	0.4	~12	280	560	210	0.4	~15	250	500	210	0.4	~18	230	580

Note

1. Please adjust cutting conditions according to machine rigidity or work rigidity. (the above table is guide for cutting on a #50 BT machine.)
2. In case of chatter occurring, recommended to reduce ap or rpm and keep feed per tooth.
3. ap should be reduced when using on low rigidity machine.
4. Use air blow.
5. Wet cutting is recommended for machining super duplex , titanium alloy and heat resistant alloy.

SKS-GII 09**SKG09/MSG09 Type**

■ Recommended cutting conditions

● MSG09 Type + MSN shank

Material	Cat.No	Grade	Tool dia.(mm)									
			40					42				
			5N					5N				
			ℓ (mm)	a_p (mm)	a_e (mm)	n (min ⁻¹)	V_f (mm/min)	ℓ (mm)	a_p (mm)	a_e (mm)	n (min ⁻¹)	V_f (mm/min)
Austenitic stainless steel (SUS304, 316, 317) 17Cr	SDEW 090312 ZER (SDET 090312 ZDER-SM)	JC7550	~120	0.8	~23	1,190	5,950	~120	0.8	~24	1,140	5,700
			200	0.6	~23	1,190	5,950	200	0.6	~24	1,140	5,700
			280	0.6	~23	990	4,210	280	0.6	~24	950	4,040
Ferritic and martensitic stainless steel (SUS403 420J2, 430) 17Cr	SDEW 090312 ZER (SDET 090312 ZDER-SM)	JC7550	~120	0.8	~23	1,510	7,550	~120	0.8	~24	1,440	7,200
			200	0.6	~23	1,510	7,550	200	0.6	~24	1,440	7,200
			280	0.6	~23	1,230	5,230	280	0.6	~24	1,170	4,970
Duplex stainless steel	SDEW 090312 ZER	JC7518 (JC7550)	~120	0.8	~23	800	1,200	~120	0.8	~24	760	1,140
			200	0.6	~23	800	1,200	200	0.6	~24	760	1,140
			280	0.6	~23	680	850	280	0.6	~24	640	800
Titanium alloy (Ti-6Al-4V) 35-43HRC	SDEW 090312 ZER	DS150 (DS118)	~120	0.8	~23	480	1,440	~120	0.8	~24	450	1,350
			200	0.6	~23	480	1,440	200	0.6	~24	450	1,350
			280	0.6	~23	400	1,000	280	0.6	~24	380	950
Heat resistant alloy (INCO718) 35-43HRC	SDEW 090312 ZER	DS118 (DS150)	~120	0.5	~23	240	720	~120	0.5	~24	230	690
			200	0.4	~23	240	720	200	0.4	~24	230	690
			280	0.4	~23	200	500	280	0.4	~24	190	480

Note

1. Please adjust cutting conditions according to machine rigidity or work rigidity. (the above table is guide for cutting on a #50 BT machine.)
2. In case of chatter occurring, recommended to reduce a_p or rpm and keep feed per tooth.
3. a_p should be reduced when using on low rigidity machine.
4. Use air blow.
5. Wet cutting is recommended for machining super duplex, titanium alloy and heat resistant alloy.

SKS-GII 09

SKG09/MSG09 Type

■ Recommended cutting conditions

● SKG09 Endmill shank type

Material	Cat.No	Grade	Tool dia.(mm)														
			25					32					35				
			3N					4N					5N				
			ℓ (mm)	ap (mm)	ae (mm)	n (min ⁻¹)	Vf (mm/min)	ℓ (mm)	ap (mm)	ae (mm)	n (min ⁻¹)	Vf (mm/min)	ℓ (mm)	ap (mm)	ae (mm)	n (min ⁻¹)	Vf (mm/min)
Austenitic stainless steel (SUS304, 316, 317) 17Cr	SDEW 090312 ZER (SDET 090312 ZDER-SM)	JC7550	~70	0.6	~9	1,910	5,730	~90	0.6	~15	1,490	5,960	~90	0.6	~18	1,360	6,800
			70~120	0.6	~9	1,590	3,820	90~140	0.6	~15	1,240	3,970	90~140	0.6	~18	1,140	4,560
Ferritic and martensitic stainless steel (SUS403 420J2, 430) 17Cr	SDEW 090312 ZER (SDET 090312 ZDER-SM)	JC7550	~70	0.6	~9	2,420	7,260	~90	0.6	~15	1,890	7,560	~90	0.6	~18	1,730	8,650
			70~120	0.6	~9	1,970	4,730	90~140	0.6	~15	1,540	4,930	90~140	0.6	~18	1,410	5,640
Duplex stainless steel	SDEW 090312 ZER	JC7518 (JC7550)	~70	0.6	~9	1,270	1,140	~90	0.6	~15	990	1,190	~90	0.6	~18	910	1,370
			70~120	0.6	~9	1,080	810	90~140	0.6	~15	850	850	90~140	0.6	~18	770	960
Titanium alloy (Ti-6Al-4V) 35-43HRC	SDEW 090312 ZER	DS150 (DS118)	~70	0.6	~9	760	1,370	~90	0.6	~15	600	1,440	~90	0.6	~18	550	1,650
			70~120	0.6	~9	640	960	90~140	0.6	~15	500	1,000	90~140	0.6	~18	450	1,130
Heat resistant alloy (INCO718) 35-43HRC	SDEW 090312 ZER	DS118 (DS150)	~70	0.5	~9	380	680	~90	0.5	~15	300	720	~90	0.5	~18	270	810
			70~120	0.5	~9	320	480	90~140	0.5	~15	250	500	90~140	0.5	~18	230	580

Note

1. Please adjust cutting conditions according to machine rigidity or work rigidity. (the above table is guide for cutting on a #50 BT machine.)
2. In case of chatter occurring, recommended to reduce ap or rpm and keep feed per tooth.
3. ap should be reduced when using on low rigidity machine.
4. Use air blow.
5. Wet cutting is recommended for machining super duplex , titanium alloy and heat resistant alloy.

SKS-GII 09**SKG09/MSG09 Type**

■ Recommended cutting conditions

● SKG09 Facemill type

Material	Cat.No	Grade	Tool dia.(mm)														
			40					50					52				
			5N					7N					7N				
			ℓ (mm)	ap (mm)	ae (mm)	n (min ⁻¹)	Vf (mm/min)	ℓ (mm)	ap (mm)	ae (mm)	n (min ⁻¹)	Vf (mm/min)	ℓ (mm)	ap (mm)	ae (mm)	n (min ⁻¹)	Vf (mm/min)
Austenitic stainless steel (SUS304, 316, 317) 17Cr	SDEW 090312 ZER (SDET 090312 ZDER-SM)	JC7550	~150	0.6	~23	1,190	5,950	~150	0.8	~32	950	6,650	~150	0.8	~33	920	6,440
			200	0.4	~23	1,190	5,950	200	0.6	~32	950	6,650	200	0.6	~33	920	6,440
			250	0.3	~23	990	4,950	250	0.4	~32	800	5,600	250	0.4	~33	770	5,390
			300	-	-	-	-	300	0.3	~32	800	5,600	300	0.3	~33	770	5,390
			350	-	-	-	-	350	0.3	~32	800	4,760	350	0.3	~33	770	4,580
Ferritic and martensitic stainless steel (SUS403 420J2, 430) 17Cr	SDEW 090312 ZER (SDET 090312 ZDER-SM)	JC7550	~150	0.6	~23	1,510	7,550	~150	0.8	~32	1,210	8,470	~150	0.8	~33	1,160	8,120
			200	0.4	~23	1,510	7,550	200	0.6	~32	1,210	8,470	200	0.6	~33	1,160	8,120
			250	0.3	~23	1,230	6,150	250	0.4	~32	990	6,930	250	0.4	~33	950	6,650
			300	-	-	-	-	300	0.3	~32	990	6,930	300	0.3	~33	950	6,650
			350	-	-	-	-	350	0.3	~32	990	5,890	350	0.3	~33	950	5,650
Duplex stainless steel	SDEW 090312 ZER	JC7518 (JC7550)	~150	0.6	~23	800	1,200	~150	0.8	~32	640	1,340	~150	0.8	~33	610	1,280
			200	0.4	~23	800	1,200	200	0.6	~32	640	1,340	200	0.6	~33	610	1,280
			250	0.3	~23	680	1,020	250	0.4	~32	540	1,130	250	0.4	~33	520	1,090
			300	-	-	-	-	300	0.3	~32	540	1,130	300	0.3	~33	520	1,090
			350	-	-	-	-	350	0.3	~32	540	950	350	0.3	~33	520	910
Titanium alloy (Ti-6Al-4V) 35-43HRC	SDEW 090312 ZER	DS150 (DS118)	~150	0.6	~23	480	1,440	~150	0.8	~32	380	1,600	~150	0.8	~33	370	1,550
			200	0.4	~23	480	1,440	200	0.6	~32	380	1,600	200	0.6	~33	370	1,550
			250	0.3	~23	400	1,200	250	0.4	~32	320	1,340	250	0.4	~33	310	1,300
			300	-	-	-	-	300	0.3	~32	320	1,340	300	0.3	~33	310	1,300
			350	-	-	-	-	350	0.3	~32	320	1,120	350	0.3	~33	310	1,090
Heat resistant alloy (INCO718) 35-43HRC	SDEW 090312 ZER	DS118 (DS150)	~150	0.5	~23	240	720	~150	0.5	~32	190	800	~150	0.5	~33	180	760
			200	0.35	~23	240	720	200	0.4	~32	190	800	200	0.4	~33	180	760
			250	0.25	~23	200	600	250	0.25	~32	160	670	250	0.25	~33	150	630
			300	-	-	-	-	300	0.2	~32	160	670	300	0.2	~33	150	630
			350	-	-	-	-	350	0.2	~32	160	560	350	0.2	~33	150	530

Note

1. Please adjust cutting conditions according to machine rigidity or work rigidity. (the above table is guide for cutting on a #50 BT machine.)
2. In case of chatter occurring, recommended to reduce ap or rpm and keep feed per tooth.
3. ap should be reduced when using on low rigidity machine.
4. Use air blow.
5. Wet cutting is recommended for machining super duplex , titanium alloy and heat resistant alloy.

SKS-GII 09**SKG09/MSG09 Type**

■ Recommended cutting conditions

● SKG09 Facemill type

Material	Cat.No	Grade	Tool dia.(mm)														
			63					66					80				
			8N					8N					9N				
			ℓ (mm)	ap (mm)	ae (mm)	n (min ⁻¹)	Vf (mm/min)	ℓ (mm)	ap (mm)	ae (mm)	n (min ⁻¹)	Vf (mm/min)	ℓ (mm)	ap (mm)	ae (mm)	n (min ⁻¹)	Vf (mm/min)
Austenitic stainless steel (SUS304, 316, 317) 17Cr	SDEW 090312 ZER (SDET 090312 ZDER-SM)	JC7550	~150	0.8	~43	760	6,080	~150	0.8	~46	720	5,760	~150	0.8	~59	600	5,400
			200	0.6	~43	760	6,080	200	0.6	~46	720	5,760	200	0.6	~59	600	5,400
			250	0.4	~43	630	5,040	250	0.4	~46	600	4,800	250	0.4	~59	500	4,500
			300	0.3	~43	630	5,040	300	0.3	~46	600	4,800	300	0.3	~59	500	4,500
			350	0.3	~43	630	4,280	350	0.3	~46	600	4,080	350	0.3	~59	500	3,830
Ferritic and martensitic stainless steel (SUS403 420J2, 430) 17Cr	SDEW 090312 ZER (SDET 090312 ZDER-SM)	JC7550	~150	0.8	~43	960	7,680	~150	0.8	~46	920	7,360	~150	0.8	~59	760	6,840
			200	0.6	~43	960	7,680	200	0.6	~46	920	7,360	200	0.6	~59	760	6,840
			250	0.4	~43	780	6,240	250	0.4	~46	750	6,000	250	0.4	~59	620	5,580
			300	0.3	~43	780	6,240	300	0.3	~46	750	6,000	300	0.3	~59	620	5,580
			350	0.3	~43	780	5,300	350	0.3	~46	750	5,100	350	0.3	~59	620	4,740
Duplex stainless steel	SDEW 090312 ZER	JC7518 (JC7550)	~150	0.8	~43	510	1,220	~150	0.8	~46	480	1,150	~150	0.8	~59	400	1,080
			200	0.6	~43	510	1,220	200	0.6	~46	480	1,150	200	0.6	~59	400	1,080
			250	0.4	~43	430	1,030	250	0.4	~46	410	980	250	0.4	~59	340	920
			300	0.3	~43	430	1,030	300	0.3	~46	410	980	300	0.3	~59	340	920
			350	0.3	~43	430	860	350	0.3	~46	410	820	350	0.3	~59	340	770
Titanium alloy (Ti-6Al-4V) 35-43HRC	SDEW 090312 ZER	DS150 (DS118)	~150	0.8	~43	300	1,440	~150	0.8	~46	290	1,390	~150	0.8	~59	240	1,300
			200	0.6	~43	300	1,440	200	0.6	~46	290	1,390	200	0.6	~59	240	1,300
			250	0.4	~43	250	1,200	250	0.4	~46	240	1,150	250	0.4	~59	200	1,080
			300	0.3	~43	250	1,200	300	0.3	~46	240	1,150	300	0.3	~59	200	1,080
			350	0.3	~43	250	1,000	350	0.3	~46	240	960	350	0.3	~59	200	900
Heat resistant alloy (INCO718) 35-43HRC	SDEW 090312 ZER	DS118 (DS150)	~150	0.5	~43	150	720	~150	0.5	~46	140	670	~150	0.5	~59	120	650
			200	0.4	~43	150	720	200	0.4	~46	140	670	200	0.4	~59	120	650
			250	0.25	~43	130	620	250	0.25	~46	120	580	250	0.25	~59	100	540
			300	0.2	~43	130	620	300	0.2	~46	120	580	300	0.2	~59	100	540
			350	0.2	~43	130	520	350	0.2	~46	120	480	350	0.2	~59	100	450

Note

1. Please adjust cutting conditions according to machine rigidity or work rigidity. (the above table is guide for cutting on a #50 BT machine.)
2. In case of chatter occurring, recommended to reduce ap or rpm and keep feed per tooth.
3. ap should be reduced when using on low rigidity machine.
4. Use air blow.
5. Wet cutting is recommended for machining super duplex , titanium alloy and heat resistant alloy.

SKS EXTREME

High-feed milling tools with double side inserts which achieve ultimate high-feed machining

Feature 1

Economical double-side insert (with 6 cutting edges)



Feature 2

Due to dovetail-shaped binding face, movement of inserts which occur by cutting force is prevented only single screw clamping

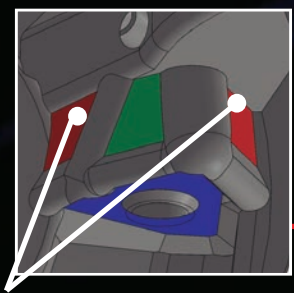

Dovetail-shaped

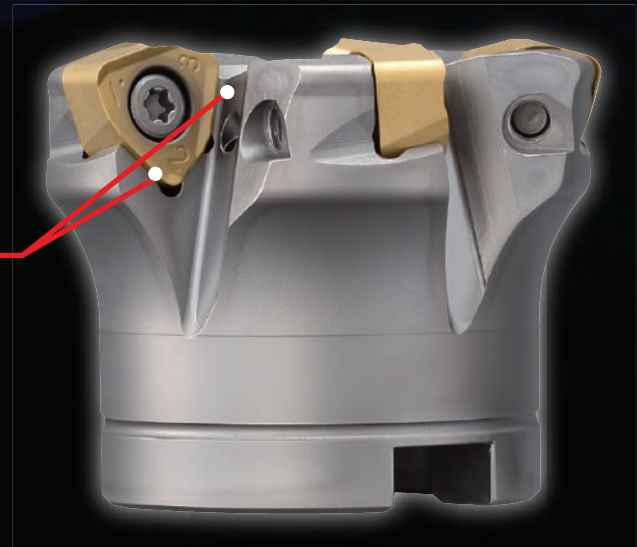

Feature 3

Application

ISO	P					M					K				H		
	P01	P10	P20	P30	P40	M01	M10	M20	M30	M40	K01	K10	K20	K30	H01	H10	H20
Applicable range			JC8050					JC8050									
		JC8118									JC8118					JC8118	
			JC7560						JC7560								

Adopted 3 insert grades:

PVD coated grade "JC7560" improved fracture toughness & heat impact resistance.

PVD coated grade "JC8118" achieved longer tool life for mold steel, high hardened die steel less than 50HRC & cast iron.

PVD coated grade "JC8050", that adopted carbide substrate with improved fracture toughness & coating layer can be widely applied for carbon steel, mold steel, & stainless steel.



M3 size screw for firm clamping of inserts

MaxAp=1.5mm

W=4.8

EXSKS-05 type

By adopting multi blade specification with small diameter, high-feed machining is possible.

WNMU050320ZER-PM

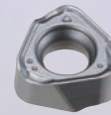

grade : JC8050
JC8118

Optimal breaker for mold steel & High hardened steel less than 50HRC

Coner radius for programming	Remains	Over cut
R2	0.59	0
R2.5	0.5	0
R3	0.41	0.13

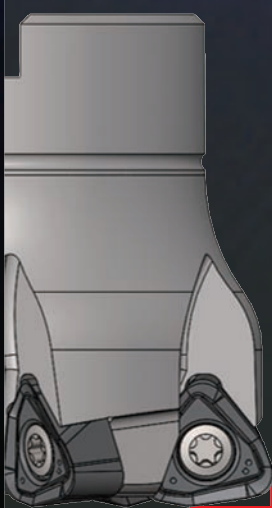

MaxAp=2mm

W=8.1

EXSKS-07type

Adopted specifications which achieved both insert strength and sharpness. Stable high-feed machining is possible.

WNMU070620ZER-PM

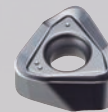

grade : JC8050
JC8118

Optimal breaker for mold steel & High hardened steel less than 50HRC

Coner radius for programming	Remains	Over cut
R3	0.80	0
R3.5	0.73	0.06
R4	0.66	0.21



Lined up holders of big diameter. High-feed machining with bigger depth of cut is possible by adopting high-rigid inserts with larger thickness.

PM insert PL insert
MaxAp=3mm (2mm)

W=8.2

EXSKS-09type

WNMU090828ZER-PL

grade: JC8050 / JC8118

Suitable for machining shapes such as pocket milling with ap = 0.6 mm to ap = 1.2 mm. The composite shape of the straight and radius cutting edges reduces fluctuations in cutting resistance during corner machining, realizing stable machining and extending tool life.

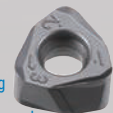

WNMU090720ZER-PM

grade : JC8050/JC8118/JC7560

Suitable for face milling of ap=1.4mm or more and shape machining such as pocket machining.

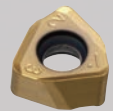

Coner radius for programming	Remains	Over cut
R3	1.41	0
R3.5	1.3	0
R4	1.19	0.025

SKS EXTREME **EXSKS/MEX Type**

- EXSKS-05 Type
- Facemill Type

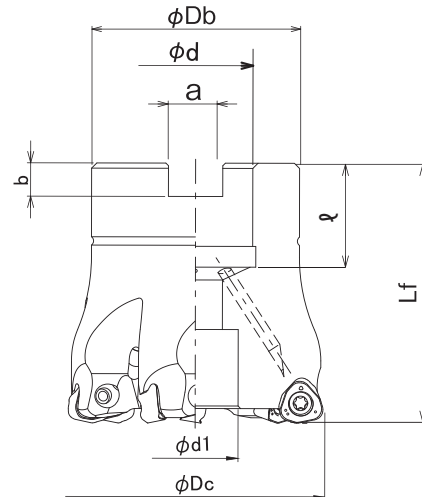

Cat.No.	Stock	No. of inserts	Dimensions (mm)								Arbor set bolt	Weight (kg)	Inserts 
			φDc	Lf	φDb	φd	φd1	a	b	φ			
EXSKS-5040R-05-16	●	5	40	45	35	16	13.5	8.4	5.8	19	M8	0.25	WNMU050320ZER-PM
EXSKS-7050R-05-22	●	7	50	50	40	22	16.5	10.4	6.3	20	M10	0.39	
EXSKS-7052R-05-22	●	7	52	50	40	22	16.5	10.4	6.3	20	M10	0.41	
EXSKS-8063R-05-22	□	8	63	50	48	22	17	10.4	6.3	20	M10	0.65	

■ Modular head type

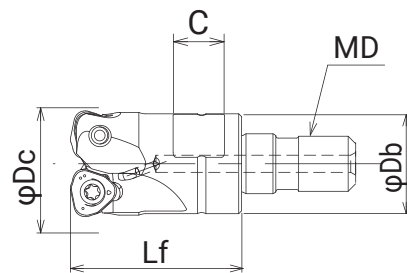
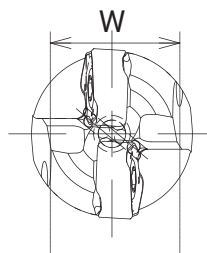

Cat.No.	Stock	No. of inserts	Dimensions (mm)						Inserts 
			φDc	Lf	φDb	MD	C	W	
MEX-2020-05-M10	●	2	20	30	18	M10	9	14	WNMU050320ZER-PM
MEX-2021-05-M10	□	2	21	30	18	M10	9	14	
MEX-3025-05-M12	●	3	25	35	23	M12	11	19	
MEX-3026-05-M12	□	3	26	35	23	M12	11	19	
MEX-3028-05-M12	□	3	28	28	23	M12	11	19	
MEX-4030-05-M16	□	4	30	43	27	M16	12	22	
MEX-4032-05-M16	●	4	32	43	29	M16	12	22	
MEX-4033-05-M16	□	4	33	43	29	M16	12	22	
MEX-4035-05-M16	●	4	35	43	29	M16	12	22	
MEX-5040-05-M16	●	5	40	43	32	M16	14	26	

SKS EXTREME **EXSKS/MEX Type**

■ Endmill Shank Type

Through coolant hole

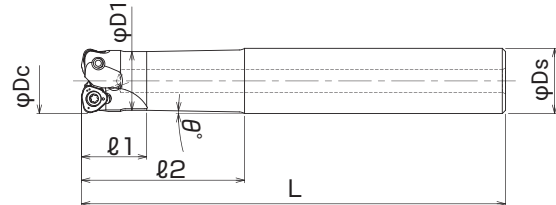

Cat.No.	Stock	No. of inserts	Dimensions (mm)							Inserts
			φDc	ℓ1	ℓ2	L	φd1	φDs	θ°	
EXSKS-2020-05-50-S20	●	2	20	20	18	130	18	20	1	WNMU050320ZER-PM
EXSKS-2020-05-80-S20	□	2	20	20	18	160	18	20	0.5	
EXSKS-2021-05-50-S20	□	2	21	20	23	130	18	20	1	
EXSKS-2021-05-80-S20	□	2	21	20	23	160	18	20	0.5	
EXSKS-3025-05-60-S25	●	3	25	25	23	140	23	25	1	
EXSKS-3025-05-100-S25	□	3	25	25	27	180	23	25	0.5	
EXSKS-3026-05-60-S25	□	3	26	25	29	140	23	25	1	
EXSKS-3026-05-100-S25	□	3	26	25	29	180	23	25	0.5	
EXSKS-4032-05-70-S32	●	4	32	30	29	150	29	32	1.5	
EXSKS-4032-05-120-S32	□	4	32	30	32	200	29	32	0.5	

Screw	Torque(N.m)	Wrench
TSW-307H	2.1	A-10

■ Insert

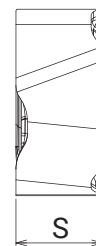
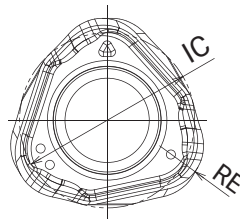

Cat.No.	Tolerance	PVD coated		Dimensions (mm)		
		JC8118	JC8050	RE	IC	S
WNMU050320ZER-PM	M	●	●	2	7.7	3.9

GRADE MARKING

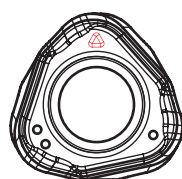

JC8050

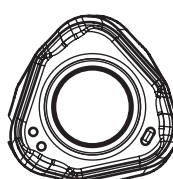

JC8118

SKS EXTREME **EXSKS/MEX Type**

- EXSKS-07 Type
- Facemill Type

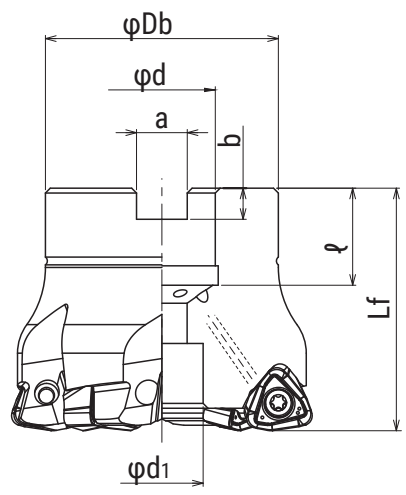
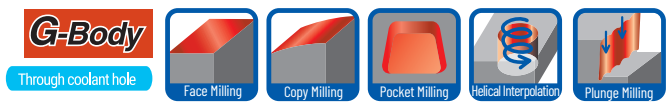

Cat.No.	Stock	No. of inserts	Dimensions (mm)								Arbor set bolt	Weight (kg)	Inserts 
			φDc	Lf	φDb	φd	φd1	a	b	φ			
EXSKS-5050R-07-22	●	5	50	50	40	22	16.5	10.4	6.3	20	M10	0.38	WNMU070620ZER-PM
EXSKS-5052R-07-22	●	5	52	50	40	22	16.5	10.4	6.3	20	M10	0.40	
EXSKS-6063R-07-22	●	6	63	50	48	22	17	10.4	6.3	20	M10	0.64	
EXSKS-7080R-07-27	●	7	80	55	65	27	20	12.4	7	22	M12X1.75X35★	1.23	

■ Modular head type

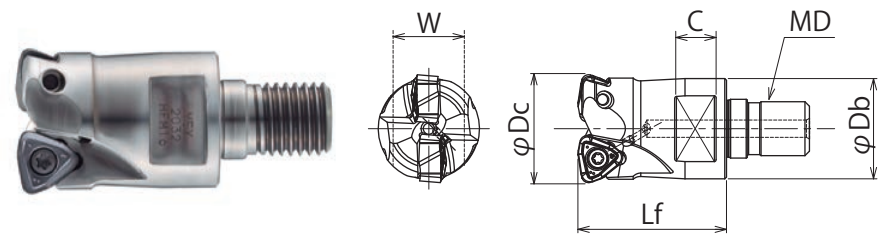

Cat.No.	Stock	No. of inserts	Dimensions (mm)						Inserts 
			φDc	Lf	φDb	MD	C	W	
MEX-2032-07-M16	●	2	32	43	29	M16	12	22	WNMU070620ZER-PM
MEX-3035-07-M16	●	3	35	43	29	M16	12	22	
MEX-4040-07-M16	●	4	40	43	32	M16	14	26	
MEX-4042-07-M16	●	4	42	43	32	M16	14	26	

SKS EXTREME **EXSKS/MEX Type**

■ Endmill Shank Type

Through coolant hole

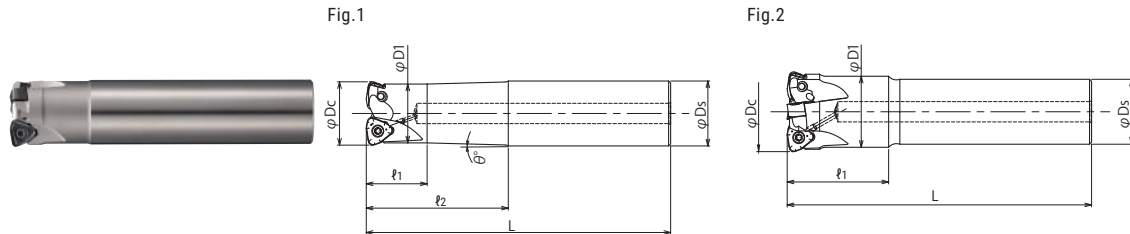

Cat.No.	Stock	No. of inserts	Dimensions (mm)								Inserts
			φDc	ℓ1	ℓ2	L	φd1	φDs	θ°	Fig.	
EXSKS-2032-07-70-S32	<input type="checkbox"/>	2	32	30	70	150	29	20	32	1	WNMU070620ZER-PM
EXSKS-2032-07-120-S32	<input type="checkbox"/>	2	32	30	120	200	29	20	32	1	
EXSKS-3035-07-40-S32	<input type="checkbox"/>	3	35	40	-	150	31	20	32	2	
EXSKS-3035-07-40L-S32	<input type="checkbox"/>	3	35	40	-	200	31	20	32	2	
EXSKS-4040-07-50-S32	<input type="checkbox"/>	4	40	50	-	150	35	25	32	2	
EXSKS-4040-07-50L-S32	<input type="checkbox"/>	4	40	50	-	200	35	25	32	2	

■ Insert

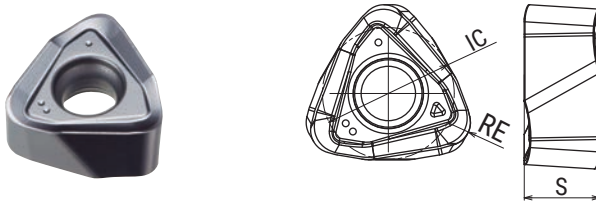

Screw	Torque(N.m)	Wrench
TSW-410H	3.5	A-15

Cat.No.	Tolerance	PVD coated		Dimensions (mm)		
		JC8118	JC8050	RE	IC	S
WNMU070620ZER-PM	M	●	●	2	11.2	6.4

GRADE MARKING

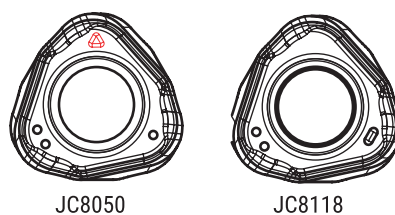

SKS EXTREME **EXSKS/MEX Type**

- EXSKS-09 Type
- Facemill Type

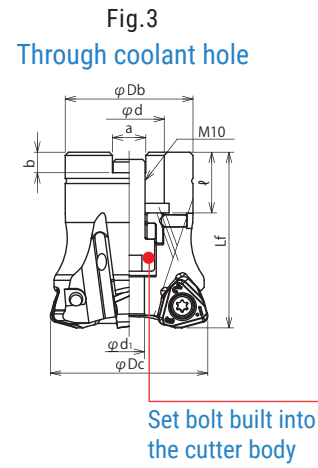
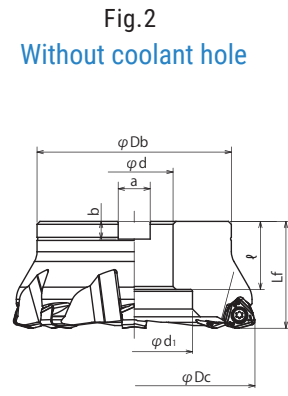
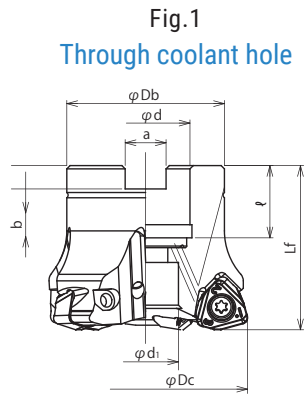

Cat.No.	Stock	No. of inserts	Dimensions (mm)								Arbor set bolt	Weight (kg)	Fig.	Inserts 
			φDc	Lf	φDb	φd	φd1	a	b	ℓ				
EXSKS-3050R-22	□	3	50	55	40	22	9.6	10.4	6.3	19	M10×1.5×25	0.4	3	WNMU090720ZER-PM WNMU090828ZER-PL
EXSKS-4050R-22	●	4	50	55	40	22	9.6	10.4	6.3	19	M10×1.5×25	0.3	3	
EXSKS-4052R-22	●	4	52	50	40	22	17	10.4	6.3	20	M10	0.4	1	
EXSKS-4063R-22	□	4	63	50	48	22	17	10.4	6.3	20	M10	0.5	1	
EXSKS-5063R-22	●	5	63	50	48	22	17	10.4	6.3	20	M10	0.5	1	
EXSKS-5063R-27	●	5	63	50	48	27	20	12.4	7	22	M12×1.75×30	0.5	1	
EXSKS-5066R-27	●	5	66	50	48	27	20	12.4	7	22	M12×1.75×30	0.5	1	
EXSKS-6080R-27	●	6	80	55	65	27	37	12.4	7	22	M12×1.75×40	0.9	1	
EXSKS-7100R-32	●	7	100	70	85	32	26	14.4	8	32	M16×2×45	1.9	1	
EXSKS-8125R-40	●	8	125	70	100	40	32	16.4	9	35	M20×2.5×45	3.9	1	
EXSKS-9160R-40	●	9	160	55	100	40	85	16.4	9	35	M20	3.9	2	

SKS EXTREME **EXSKS/MEX Type**

■ **Insert**

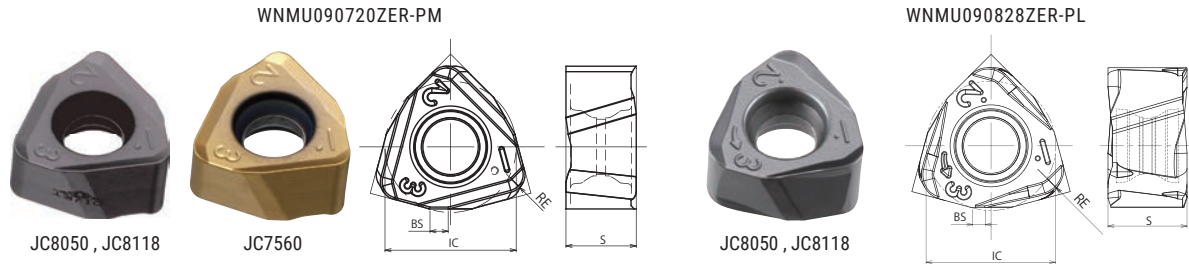

Cat.No.	Tolerance	PVD coated			Dimensions (mm)			
		JC8118	JC8050	JC7560	IC	S	BS	RE
WNMU090720ZER-PM	M	●	●	●	14	7.66	1.94	2
WNMU090828ZER-PL	M	●	●		13.91	8.66	1.37	2.8

Note: When using PL inserts, tool dia. will be smaller than PM insert.
 In case dia. $\phi 100$ holder, tool dia. is 0.06mm smaller.
 In case dia. $\phi 125$ holder, tool dia. is 0.11mm smaller.
 In case dia. $\phi 160$ holder, tool dia. is 0.15mm smaller

Screw	Torque(N.m)	Wrench
CSW-513H	5.5	A-20

GRADE MARKING

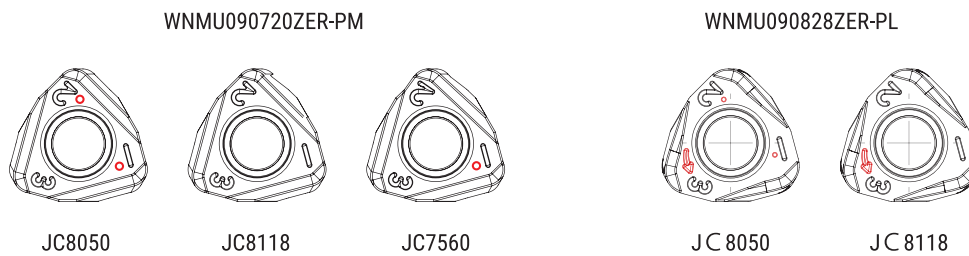

SKS EXTREME **EXSKS/MEX Type**

■ **EXSKS-05 type : Definition of corner shape for programming**

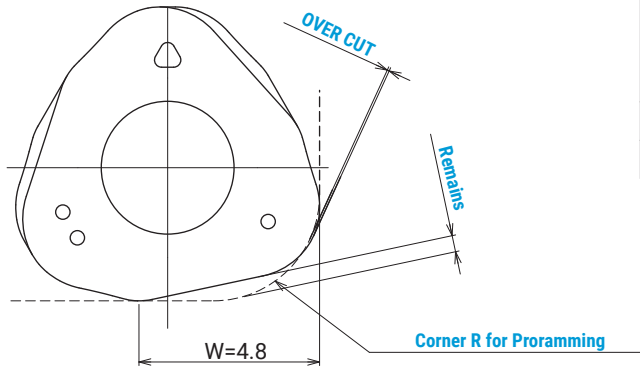

Corner radius for programming	Remains	Over cut
R2.0	0.59	0
R2.5 (Std.)	0.5	0
R3.0	0.41	0.13

(mm)

Attention for profile milling

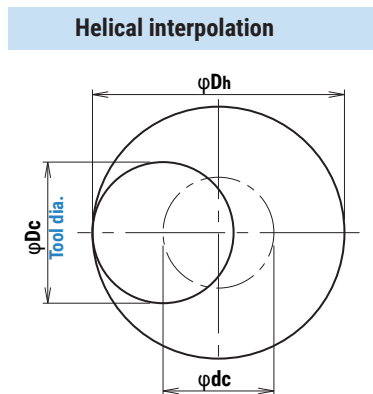
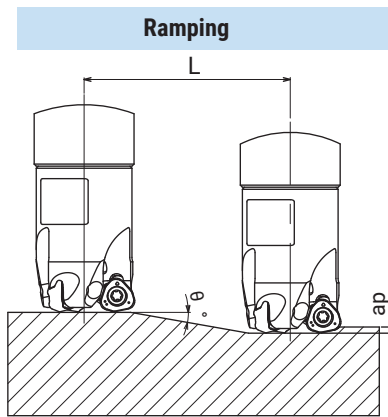

● **Calculation of tool pass dia.**

$$\varphi Dc = \varphi Dh - \varphi Dc$$

Tool pass dia. Bore dia. Tool dia.

- Depth of cut per one circuit should not exceed max. depth of cut ap.
- Down cutting is recommended, so tool pass rotation should be counterclockwise.
- To obtain a flat bottom surface when helical milling, it requires to remove "the uncut part" in the center of the work material at a final pass.

- In case of ramping and helical interpolation, apply 70% or less feed speed from standard cutting condition table.
- In case of drilling, apply 50% or less Z axis feed speed from standard cutting condition table.
- Long consecutive chips may come out in case of drilling, confirm the safe condition sufficiently.

Cat. No.	Tool dia. (mm)	EFF. Cutting dia. (mm)	Max. depth of cut (mm) ap	Ramping		Helical interpolation			Max. drilling depth Z (mm)
				Max. ramping angle θ°	Total cutting length at Max ap	Min. bore dia. Dh min (mm)	Max. bore dia. Dh min (mm)	Dh min (mm)	
EXSKS-*020/MEX-*020	20	10	1.5	2.8	31	28	36	31	0.4
EXSKS-*021/MEX-*021	21	11	1.5	2.6	34	30	38	33	0.4
EXSKS-*025/MEX-*025	25	15	1.5	1.8	48	38	46	41	0.4
EXSKS-*026/MEX-*026	26	16	1.5	1.7	51	40	48	43	0.4
EXSKS-*028/MEX-*028	28	18	1.5	1.5	58	44	52	47	0.4
MEX-*030	30	20	1.5	1.3	67	48	56	51	0.4
EXSKS-*032/MEX-*032	32	22	1.5	1.2	72	52	60	55	0.4
MEX-*033	33	23	1.5	1.1	79	54	62	57	0.4
MEX-*035	35	25	1.5	1	86	58	66	61	0.4
EXSKS-*040/MEX-*040	40	30	1.5	0.8	108	68	76	71	0.4
EXSKS-*050	50	40	1.5	0.6	144	88	96	91	0.4
EXSKS-*052	52	42	1.5	0.6	144	92	100	95	0.4
EXSKS-*063	63	53	1.5	0.5	172	114	122	117	0.4

SKS EXTREME **EXSKS/MEX Type**

■ EXSKS-07 type : Definition of corner shape for programming

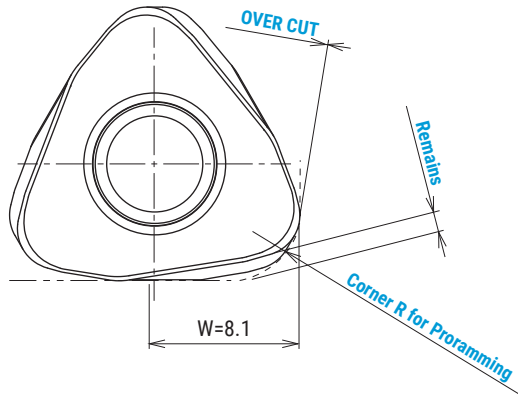

Corner radius for programming	Remains	Over cut
R3.0 (Std.)	0.8	0
R3.5	0.73	0.06
R4.0	0.66	0.21

(mm)

Attention for profile milling

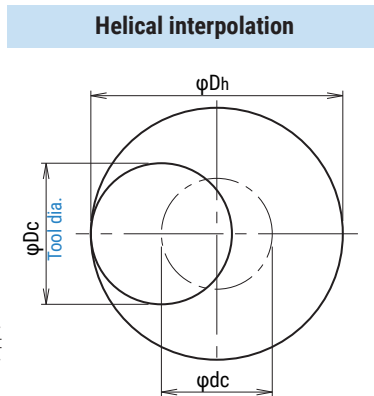
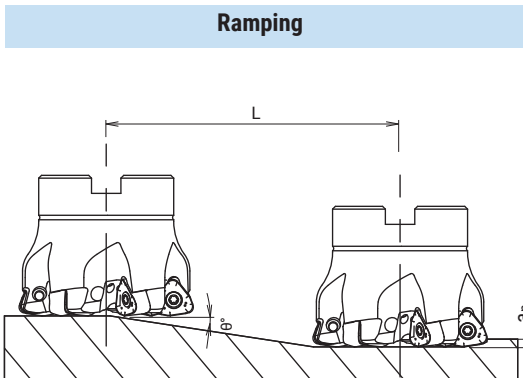

● Calculation of tool pass dia.

$$\varphi_{dc} = \varphi_{Dh} - \varphi_{Dc}$$

Tool pass dia. Bore dia. Tool dia.

- Depth of cut per one circuit should not exceed max. depth of cut ap.
- Down cutting is recommended, so tool pass rotation should be counterclockwise.
- To obtain a flat bottom surface when helical milling, it requires to remove "the uncut part" in the center of the work material at a final pass.

- In case of ramping and helical interpolation, apply 70% or less feed speed from standard cutting condition table.
- In case of drilling, apply 50% or less Z axis feed speed from standard cutting condition table.
- Long consecutive chips may come out in case of drilling, confirm the safe condition sufficiently.

Cat. No.	Tool dia. (mm)	EFF. Cutting dia. (mm)	Max. depth of cut (mm) ap	Ramping		Helical interpolation			Max. drilling depth Z (mm)
				Max. ramping angle θ°	Total cutting length at Max ap	Min. bore dia. Dh min (mm)	Max. bore dia. Dh min (mm)	Dh min (mm)	
EXSKS-*032/MEX-*032	32	15	2	2.2	53	41	60	48	0.5
EXSKS-*035/MEX-*035	35	18	2	2.1	55	47	66	54	0.5
EXSKS-*040/MEX-*040	40	23	2	2	58	57	76	64	0.5
MEX-*042	42	25	2	1.8	64	61	80	68	0.5
EXSKS-*050	50	33	2	1.5	77	77	96	84	0.5
EXSKS-*052	52	35	2	1.2	96	81	100	88	0.5
EXSKS-*063	63	46	2	1	115	103	122	110	0.5
EXSKS-*080	80	63	2	0.8	144	137	156	144	0.5

SKS EXTREME **EXSKS/MEX Type**

■ EXSKS-09 type : Definition of corner shape for programming

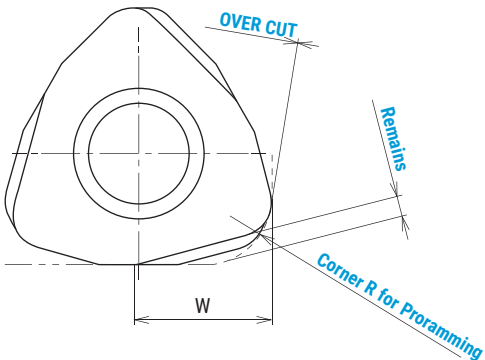

Insert	W	Corner radius for programming	Remains	Over cut
WNMU090720ZER-PM	8.2	R3.0	1.41	0
		R3.5	1.30	0
		R4.0	1.19	0.025
Insert	W	Corner radius for programming	Remains	Over cut
WNMU090828ZER-PL	8.4	R3.0	1.18	0
		R3.5	1.06	0
		R4.0	0.95	0.010

Attention for profile milling

Ramping

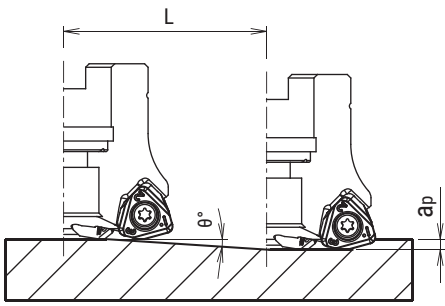

Helical interpolation

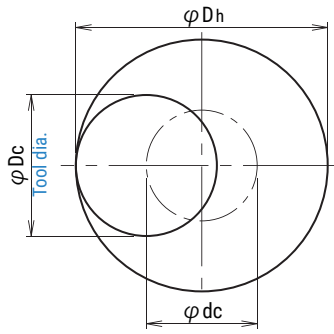

● Calculation of tool pass dia.

$$\phi dc = \phi Dh - \phi Dc$$

Tool pass dia. Bore dia. Tool dia.

- Depth of cut per one circuit should not exceed max. depth of cut ap.
- Down cutting is recommended, so tool pass rotation should be counterclockwise.
- To obtain a flat bottom surface when helical milling, it requires to remove "the uncut part" in the center of the work material at a final pass.

- In case of ramping and helical interpolation, apply 70% or less feed speed from standard cutting condition table.
- In case of drilling, apply 50% or less Z axis feed speed from standard cutting condition table.
- Long consecutive chips may come out in case of drilling, confirm the safe condition sufficiently.

WNMU090720ZER-PM

Cat. No.	Tool dia. (mm)	EFF. Cutting dia. (mm)	Max. depth of cut (mm) ap	Ramping		Helical interpolation			Max. drilling depth Z (mm)
				Max. ramping angle θ°	Total cutting length at Max ap	Min. bore dia. Dh min (mm)	Max. bore dia. Dh min (mm)	Dh min (mm)	
EXSKS-*050	50	33	3	2.5	69	73	96	81	1.1
EXSKS-*052	52	35	3	2.4	72	77	100	85	1.2
EXSKS-*063	63	46	3	1.8	96	99	122	107	1.2
EXSKS-*066	66	49	3	1.7	102	105	128	113	1.2
EXSKS-*080	80	63	3	1.3	133	133	156	141	1.3
EXSKS-*100	100	83	3	1	172	173	196	181	1.3
EXSKS-*125	125	108	3	0.9	191	223	246	231	1.3
EXSKS-*160	160	143	3	0.7	246	293	316	301	1.7

WNMU090828ZER-PL

Cat. No.	Tool dia. (mm)	EFF. Cutting dia. (mm)	Max. depth of cut (mm) ap	Ramping		Helical interpolation			Max. drilling depth Z (mm)
				Max. ramping angle θ°	Total cutting length at Max ap	Min. bore dia. Dh min (mm)	Max. bore dia. Dh min (mm)	Dh min (mm)	
EXSKS-*050	50	33	2	2.3	50	74	96	82	1
EXSKS-*052	52	35	2	2.2	53	78	100	86	1
EXSKS-*063	63	46	2	1.8	64	100	122	108	1.2
EXSKS-*066	66	49	2	1.7	68	106	128	114	1.2
EXSKS-*080	80	63	2	1.3	89	134	156	142	1.3
EXSKS-*100	99.94	83	2	1	115	174	195	182	1.3
EXSKS-*125	124.89	108	2	0.9	128	224	245	232	1.4
EXSKS-*160	159.85	142	2	0.7	164	294	315	302	1.6

SKS EXTREME**EXSKS/MEX Type**

■ Recommended cutting conditions

● MEX05 Modular Head type + MSN Shank

Material	Grade	Tool dia.(mm)									
		20/21					25/26/28				
		2N					3N				
		ℓ (mm)	a _p (mm)	a _e (mm)	n (min ⁻¹)	V _f (mm/min)	ℓ (mm)	a _p (mm)	a _e (mm)	n (min ⁻¹)	V _f (mm/min)
Carbon steel (S50C, S55C) below 250HB	JC8050 (JC8118)	~60	0.8	~9	3,180	7,630	~75	0.8	~14	2,550	9,180
		100	0.7	~9	3,180	7,000	125	0.7	~14	2,550	8,420
		140	0.5	~9	2,860	5,720	175	0.5	~14	2,290	6,870
Tool & die steel (SKD61, SKD11) below 255HB	JC8050 (JC8118)	~60	0.8	~9	2,860	6,860	~75	0.8	~14	2,290	8,240
		100	0.7	~9	2,860	6,290	125	0.7	~14	2,290	7,560
		140	0.5	~9	2,550	5,100	175	0.5	~14	2,040	6,120
Mold steel (HPM7, PX5, P20) 30-36 HRC	JC8118 (JC8050)	~60	0.8	~9	2,860	6,860	~75	0.8	~14	2,290	8,240
		100	0.7	~9	2,860	6,290	125	0.7	~14	2,290	7,560
		140	0.5	~9	2,550	5,100	175	0.5	~14	2,040	6,120
Mold steel (NAK80, HPM1, P21) 38-43HRC	JC8118 (JC8050)	~60	0.6	~9	2,070	4,140	~75	0.6	~14	1,660	4,980
		100	0.6	~9	2,070	3,310	125	0.6	~14	1,660	3,980
		140	0.5	~9	1,750	2,800	175	0.5	~14	1,400	3,360
Hardened die steel (SKD61, DAC, DHA) 42-52HRC	JC8118	~60	0.6	~9	1,590	2,540	~75	0.6	~14	1,270	3,050
		100	0.6	~9	1,590	2,540	125	0.6	~14	1,270	3,050
		140	0.5	~9	1,430	1,720	175	0.5	~14	1,150	2,070
Grey cast iron (FC250) 160-260HB	JC8118 (JC8050)	~60	1	~9	3,180	8,900	~75	1	~14	2,550	10,710
		100	0.8	~9	3,180	7,630	125	0.8	~14	2,550	9,180
		140	0.6	~9	2,860	5,720	175	0.6	~14	2,290	6,870
Nodular cast iron (FCD700) 170-300HB	JC8118 (JC8050)	~60	1	~9	2,860	6,860	~75	1	~14	2,290	8,240
		100	0.8	~9	2,860	6,290	125	0.8	~14	2,290	7,560
		140	0.6	~9	2,550	5,100	175	0.6	~14	2,040	6,120
Austenitic stainless steel (SUS304, 316, 317) 17Cr	JC8050	~60	0.6	~9	2,390	4,780	~75	0.6	~14	1,910	5,730
		100	0.5	~9	2,390	4,300	125	0.5	~14	1,910	5,160
		140	0.5	~9	2,070	3,310	175	0.5	~14	1,660	3,980
Ferritic & martensitic stainless steel (SUS403 420J2, 430) 13Cr	JC8118 (JC8050)	~60	0.8	~9	2,710	6,500	~75	0.8	~14	2,160	7,780
		100	0.7	~9	2,710	6,500	125	0.7	~14	2,160	7,780
		140	0.5	~9	2,390	4,780	175	0.5	~14	1,910	5,730

Note

1. Please adjust cutting conditions according to machine rigidity or work rigidity. (the above table is guide for cutting on a #50 BT machine.)
2. In case of chatter occurring, recommended to reduce a_p or rpm and keep feed per tooth.
3. a_p should be reduced when using on low rigidity machine.
4. Use air blow.

SKS EXTREME **EXSKS/MEX Type**

- Recommended cutting conditions
- MEX05 Modular Head type + MSN Shank

Material	Grade	Tool dia.(mm)									
		30/32/33/35					40				
		4N					5N				
		ℓ (mm)	ap (mm)	ae (mm)	n (min ⁻¹)	Vf (mm/min)	ℓ (mm)	ap (mm)	ae (mm)	n (min ⁻¹)	Vf (mm/min)
Carbon steel (S50C, S55C) below 250HB	JC8050 (JC8118)	~90	0.8	~20	1,990	9,550	~120	0.8	~28	1,430	8,580
		150	0.7	~20	1,990	8,760	200	0.7	~28	1,430	7,870
		210	0.5	~20	1,790	7,160	280	0.5	~28	1,270	6,350
Tool & die steel (SKD61, SKD11) below 255HB	JC8050 (JC8118)	~90	0.8	~20	1,790	8,590	~120	0.8	~28	1,270	7,620
		150	0.7	~20	1,790	7,880	200	0.7	~28	1,270	6,990
		210	0.5	~20	1,590	6,360	280	0.5	~28	1,110	5,550
Mold steel (HPM7, PX5, P20) 30-36 HRC	JC8118 (JC8050)	~90	0.8	~20	1,790	8,590	~120	0.8	~28	1,270	7,620
		150	0.7	~20	1,790	7,880	200	0.7	~28	1,270	6,990
		210	0.5	~20	1,590	6,360	280	0.5	~28	1,110	5,550
Mold steel (NAK80, HPM1, P21) 38-43HRC	JC8118 (JC8050)	~90	0.6	~20	1,290	5,160	~120	0.6	~28	880	4,400
		150	0.6	~20	1,290	4,130	200	0.6	~28	880	3,520
		210	0.5	~20	1,090	3,490	280	0.5	~28	720	2,880
Hardened die steel (SKD61, DAC, DHA) 42-52HRC	JC8118	~90	0.6	~20	990	3,170	~120	0.6	~28	720	2,880
		150	0.6	~20	990	3,170	200	0.6	~28	720	2,880
		210	0.5	~20	900	2,160	280	0.5	~28	560	1,680
Grey cast iron (FC250) 160-260HB	JC8118 (JC8050)	~90	1	~20	1,990	11,140	~120	1	~28	1,430	10,010
		150	0.8	~20	1,990	9,550	200	0.8	~28	1,430	8,580
		210	0.6	~20	1,790	7,160	280	0.6	~28	1,270	6,350
Nodular cast iron (FCD700) 170-300HB	JC8118 (JC8050)	~90	1	~20	1,790	8,590	~120	1	~28	1,270	7,620
		150	0.8	~20	1,790	7,880	200	0.8	~28	1,270	6,990
		210	0.6	~20	1,590	6,360	280	0.6	~28	1,110	5,550
Austenitic stainless steel (SUS304, 316, 317) 17Cr	JC8050	~90	0.6	~20	1,490	5,960	~120	0.6	~28	1,030	5,150
		150	0.5	~20	1,490	5,360	200	0.5	~28	1,030	4,640
		210	0.5	~20	1,290	4,130	280	0.5	~28	880	3,520
Ferritic & martensitic stainless steel (SUS403 420J2, 430) 13Cr	JC8118 (JC8050)	~90	0.8	~20	1,690	8,110	~120	0.8	~28	1,190	7,140
		150	0.7	~20	1,690	8,110	200	0.7	~28	1,190	7,140
		210	0.5	~20	1,490	5,960	280	0.5	~28	1,030	5,150

Note

1. Please adjust cutting conditions according to machine rigidity or work rigidity. (the above table is guide for cutting on a #50 BT machine.)
2. In case of chatter occurring, recommended to reduce ap or rpm and keep feed per tooth.
3. ap should be reduced when using on low rigidity machine.
4. Use air blow.

SKS EXTREME**EXSKS/MEX Type**

■ Recommended cutting conditions

● EXSKS05 Endmill type

Material	Grade	Tool dia.(mm)									
		20/21					25/26				
		2N					3N				
		ℓ (mm)	a _p (mm)	a _e (mm)	n (min ⁻¹)	V _f (mm/min)	ℓ (mm)	a _p (mm)	a _e (mm)	n (min ⁻¹)	V _f (mm/min)
Carbon steel (S50C, S55C) below 250HB	JC8050 (JC8118)	~60	0.7	~9	3,180	7,630	~70	0.7	~14	2,550	9,180
		60~100	0.6	~9	3,180	7,000	70~120	0.6	~14	2,550	8,420
		-	-	-	-	-	-	-	-	-	-
Tool & die steel (SKD61, SKD11) below 255HB	JC8050 (JC8118)	~60	0.7	~9	2,860	6,860	~70	0.7	~14	2,290	8,240
		60~100	0.6	~9	2,860	6,290	70~120	0.6	~14	2,290	7,560
		-	-	-	-	-	-	-	-	-	-
Mold steel (HPM7, PX5, P20) 30-36 HRC	JC8118 (JC8050)	~60	0.6	~9	2,860	6,860	~70	0.6	~14	2,290	8,240
		60~100	0.5	~9	2,860	6,290	70~120	0.5	~14	2,290	7,560
		-	-	-	-	-	-	-	-	-	-
Mold steel (NAK80, HPM1, P21) 38-43HRC	JC8118 (JC8050)	~60	0.5	~9	2,070	4,140	~70	0.5	~14	1,660	4,980
		60~100	0.4	~9	2,070	3,310	70~120	0.4	~14	1,660	3,980
		-	-	-	-	-	-	-	-	-	-
Hardened die steel (SKD61, DAC, DHA) 42-52HRC	JC8118	~60	0.5	~9	1,590	2,540	~70	0.5	~14	1,270	3,050
		60~100	0.4	~9	1,590	2,540	70~120	0.4	~14	1,270	3,050
		-	-	-	-	-	-	-	-	-	-
Grey cast iron (FC250) 160-260HB	JC8118 (JC8050)	~60	0.8	~9	3,180	8,900	~70	0.8	~14	2,550	10,710
		60~100	0.7	~9	3,180	7,630	70~120	0.7	~14	2,550	9,180
		-	-	-	-	-	-	-	-	-	-
Nodular cast iron (FCD700) 170-300HB	JC8118 (JC8050)	~60	0.8	~9	2,860	6,860	~70	0.8	~14	2,290	8,240
		60~100	0.7	~9	2,860	6,290	70~120	0.7	~14	2,290	7,560
		-	-	-	-	-	-	-	-	-	-
Austenitic stainless steel (SUS304, 316, 317) 17Cr	JC8050	~60	0.6	~9	2,390	4,780	~70	0.6	~14	1,910	5,730
		60~100	0.5	~9	2,390	4,300	70~120	0.5	~14	1,910	5,160
		-	-	-	-	-	-	-	-	-	-
Ferritic & martensitic stainless steel (SUS403 420J2, 430) 13Cr	JC8118 (JC8050)	~60	0.7	~9	2,710	6,500	~70	0.7	~14	2,160	7,780
		60~100	0.6	~9	2,710	6,500	70~120	0.6	~14	2,160	7,780
		-	-	-	-	-	-	-	-	-	-

Note

1. Please adjust cutting conditions according to machine rigidity or work rigidity. (the above table is guide for cutting on a #50 BT machine.)
2. In case of chatter occurring, recommended to reduce a_p or rpm and keep feed per tooth.
3. a_p should be reduced when using on low rigidity machine.
4. Use air blow.

SKS EXTREME
EXSKS/MEX Type
■ Recommended cutting conditions
● EXSKS05 Endmill type

Material	Grade	Tool dia.(mm)				
		32				
		4N				
		ℓ (mm)	ap (mm)	ae (mm)	n (min ⁻¹)	Vf (mm/min)
Carbon steel (S50C, S55C) below 250HB	JC8050 (JC8118)	~200	0.7	~20	1,990	9,550
		90~140	0.6	~20	1,990	8,760
		-	-	-	-	-
Tool & die steel (SKD61, SKD11) below 255HB	JC8050 (JC8118)	~200	0.7	~20	1,790	8,590
		90~140	0.6	~20	1,790	7,880
		-	-	-	-	-
Mold steel (HPM7, PX5, P20) 30-36 HRC	JC8118 (JC8050)	~200	0.6	~20	1,790	8,590
		90~140	0.5	~20	1,790	7,880
		-	-	-	-	-
Mold steel (NAK80, HPM1, P21) 38-43HRC	JC8118 (JC8050)	~200	0.5	~20	1,290	5,160
		90~140	0.4	~20	1,290	4,130
		-	-	-	-	-
Hardened die steel (SKD61, DAC, DHA) 42-52HRC	JC8118	~200	0.5	~20	990	3,170
		90~140	0.4	~20	990	3,170
		-	-	-	-	-
Grey cast iron (FC250) 160-260HB	JC8118 (JC8050)	~200	0.8	~20	1,990	11,140
		90~140	0.7	~20	1,990	9,550
		-	-	-	-	-
Nodular cast iron (FCD700) 170-300HB	JC8118 (JC8050)	~200	0.8	~20	1,790	8,590
		90~140	0.7	~20	1,790	7,880
		-	-	-	-	-
Austenitic stainless steel (SUS304, 316, 317) 17Cr	JC8050	~200	0.6	~20	1,490	5,960
		90~140	0.5	~20	1,490	5,360
		-	-	-	-	-
Ferritic & martensitic stainless steel (SUS403 420J2, 430) 13Cr	JC8118 (JC8050)	~200	0.7	~20	1,690	8,110
		90~140	0.6	~20	1,690	8,110
		-	-	-	-	-

Note

1. Please adjust cutting conditions according to machine rigidity or work rigidity.
2. In case of chatter occurring, recommended to reduce ap or rpm and keep feed per tooth.
3. ap should be reduced when using on low rigidity machine.
4. Use air blow.

SKS EXTREME**EXSKS/MEX Type**

■ Recommended cutting conditions

● EXSKS05 Facemill type

Material	Grade	Tool dia.(mm)									
		40					50/52				
		5N					7N				
		ℓ (mm)	a _p (mm)	a _e (mm)	n (min ⁻¹)	V _f (mm/min)	ℓ (mm)	a _p (mm)	a _e (mm)	n (min ⁻¹)	V _f (mm/min)
Carbon steel (S50C, S55C) below 250HB	JC8050 (JC8118)	~150	1	~28	1,270	7,620	~150	1	~38	1,020	8,570
		200	0.8	~28	1,270	6,990	200	0.8	~38	1,020	7,850
		250	0.6	~28	1,110	5,550	250	0.6	~38	890	6,230
		300	-	-	-	-	300	0.5	~38	830	4,650
		350	-	-	-	-	350	-	-	-	-
Tool & die steel (SKD61, SKD11) below 255HB	JC8050 (JC8118)	~150	1	~28	1,190	7,140	~150	1	~38	950	7,980
		200	0.8	~28	1,190	6,550	200	0.8	~38	950	7,320
		250	0.6	~28	1,030	5,150	250	0.6	~38	830	5,810
		300	-	-	-	-	300	0.5	~38	760	4,260
		350	-	-	-	-	350	-	-	-	-
Mold steel (HPM7, PX5, P20) 30-36 HRC	JC8118 (JC8050)	~150	1	~28	1,190	7,140	~150	1	~38	950	7,980
		200	0.8	~28	1,190	6,550	200	0.8	~38	950	7,320
		250	0.6	~28	1,030	5,150	250	0.6	~38	830	5,810
		300	-	-	-	-	300	0.5	~38	760	4,260
		350	-	-	-	-	350	-	-	-	-
Mold steel (NAK80, HPM1, P21) 38-43HRC	JC8118 (JC8050)	~150	0.8	~28	880	4,400	~150	0.8	~38	700	4,900
		200	0.6	~28	880	3,520	200	0.6	~38	700	3,920
		250	0.5	~28	720	2,880	250	0.5	~38	570	3,190
		300	-	-	-	-	300	0.4	~38	510	2,860
		350	-	-	-	-	350	-	-	-	-
Hardened die steel (SKD61, DAC, DHA) 42-52HRC	JC8118	~150	0.7	~28	720	2,880	~150	0.7	~38	570	3,190
		200	0.6	~28	720	2,880	200	0.6	~38	570	3,190
		250	0.5	~28	560	1,680	250	0.5	~38	450	1,890
		300	-	-	-	-	300	-	-	-	-
		350	-	-	-	-	350	-	-	-	-
Grey cast iron (FC250) 160-260HB	JC8118 (JC8050)	~150	1	~28	1,430	10,010	~150	1	~38	1,150	11,270
		200	0.8	~28	1,430	8,580	200	0.8	~38	1,150	9,660
		250	0.6	~28	1,270	6,350	250	0.6	~38	1,020	7,140
		300	-	-	-	-	300	0.5	~38	890	6,230
		350	-	-	-	-	350	-	-	-	-
Nodular cast iron (FCD700) 170-300HB	JC8118 (JC8050)	~150	1	~28	1,270	7,620	~150	1	~38	1,020	8,570
		200	0.8	~28	1,270	6,990	200	0.8	~38	1,020	7,850
		250	0.6	~28	1,110	5,550	250	0.6	~38	890	6,230
		300	-	-	-	-	300	0.5	~38	760	4,790
		350	-	-	-	-	350	-	-	-	-
Austenitic stainless steel (SUS304, 316, 317) 17Cr	JC8050	~150	0.8	~28	1,030	5,150	~150	0.8	~38	830	5,810
		200	0.6	~28	1,030	4,640	200	0.6	~38	830	5,230
		250	0.5	~28	880	3,520	250	0.5	~38	700	3,920
		300	-	-	-	-	300	0.4	~38	640	3,580
		350	-	-	-	-	350	-	-	-	-
Ferritic & martensitic stainless steel (SUS403 420J2, 430) 13Cr	JC8118 (JC8050)	~150	1	~28	1,190	7,140	~150	1	~38	950	7,980
		200	0.8	~28	1,190	7,140	200	0.8	~38	950	7,980
		250	0.6	~28	1,030	5,150	250	0.6	~38	830	5,810
		300	-	-	-	-	300	0.5	~38	-	-
		350	-	-	-	-	350	-	-	-	-

Note

1. Please adjust cutting conditions according to machine rigidity or work rigidity. (the above table is guide for cutting on a #50 BT machine.)
2. In case of chatter occurring, recommended to reduce a_p or rpm and keep feed per tooth.
3. a_p should be reduced when using on low rigidity machine.
4. Use air blow.

SKS EXTREME**EXSKS/MEX Type**

■ Recommended cutting conditions

● EXSKS05 Facemill type

Material	Grade	Tool dia.(mm)				
		63				
		8N				
		ℓ (mm)	ap (mm)	ae (mm)	n (min ⁻¹)	Vf (mm/min)
Carbon steel (S50C, S55C) below 250HB	JC8050 (JC8118)	~150	1	~46	810	6,800
		200	0.8	~46	810	6,240
		250	0.6	~46	710	4,970
		300	0.5	~46	660	3,700
		350	0.4	~46	610	3,420
Tool & die steel (SKD61, SKD11) below 255HB	JC8050 (JC8118)	~150	1	~46	760	6,380
		200	0.8	~46	760	5,850
		250	0.6	~46	660	4,620
		300	0.5	~46	610	3,420
		350	0.4	~46	560	3,140
Mold steel (HPM7, PX5, P20) 30-36 HRC	JC8118 (JC8050)	~150	1	~46	760	6,380
		200	0.8	~46	760	5,850
		250	0.6	~46	660	4,620
		300	0.5	~46	610	3,420
		350	0.4	~46	560	3,140
Mold steel (NAK80, HPM1, P21) 38-43HRC	JC8118 (JC8050)	~150	0.8	~46	560	3,920
		200	0.6	~46	560	3,140
		250	0.5	~46	450	2,520
		300	0.4	~46	400	2,240
		350	-	-	-	-
Hardened die steel (SKD61, DAC, DHA) 42-52HRC	JC8118	~150	0.7	~46	450	2,520
		200	0.6	~46	450	2,520
		250	0.5	~46	350	1,470
		300	-	-	-	-
		350	-	-	-	-
Grey cast iron (FC250) 160-260HB	JC8118 (JC8050)	~150	1	~46	910	8,920
		200	0.8	~46	910	7,640
		250	0.6	~46	810	5,670
		300	0.5	~46	710	4,970
		350	0.5	~46	660	4,160
Nodular cast iron (FCD700) 170-300HB	JC8118 (JC8050)	~150	1	~46	810	6,800
		200	0.8	~46	810	6,240
		250	0.6	~46	710	4,970
		300	0.5	~46	610	3,840
		350	0.5	~46	560	3,140
Austenitic stainless steel (SUS304, 316, 317) 17Cr	JC8050	~150	0.8	~46	660	4,620
		200	0.6	~46	660	4,160
		250	0.5	~46	560	3,140
		300	0.4	~46	510	2,860
		350	0.4	~46	450	2,520
Ferritic & martensitic stainless steel (SUS403 420J2, 430) 13Cr	JC8118 (JC8050)	~150	1	~46	760	6,380
		200	0.8	~46	760	6,380
		250	0.6	~46	660	4,620
		300	0.5	~46	560	3,920
		350	0.5	~46	510	3,570

Note

1. Please adjust cutting conditions according to machine rigidity or work rigidity. (the above table is guide for cutting on a #50 BT machine.)
2. In case of chatter occurring, recommended to reduce ap or rpm and keep feed per tooth.
3. ap should be reduced when using on low rigidity machine.
4. Use air blow.

SKS EXTREME**EXSKS/MEX Type**

■ Recommended cutting conditions

● MEX07 Modular Head type + MSN Shank

Material	Grade	Tool dia.(mm)									
		32					35				
		2N					3N				
		ℓ (mm)	a _p (mm)	a _e (mm)	n (min ⁻¹)	V _f (mm/min)	ℓ (mm)	a _p (mm)	a _e (mm)	n (min ⁻¹)	V _f (mm/min)
Carbon steel (S50C, S55C) below 250HB	JC8050	~100	1	~14	1,990	5,970	~100	1	~18	1,820	8,190
		150	0.8	~14	1,990	5,570	150	0.8	~18	1,820	7,640
		210	0.6	~14	1,790	4,650	210	0.6	~18	1,640	6,400
Tool & die steel (SKD61, SKD11) below 255HB	JC8050	~100	1	~14	1,790	5,370	~100	1	~18	1,640	7,380
		150	0.8	~14	1,790	5,010	150	0.8	~18	1,640	6,890
		210	0.6	~14	1,590	4,130	210	0.6	~18	1,460	5,690
Mold steel (HPM7, PX5, P20) 30-36 HRC	JC8118	~100	1	~14	1,790	5,370	~100	1	~18	1,640	7,380
		150	0.8	~14	1,790	5,010	150	0.8	~18	1,640	6,890
		210	0.6	~14	1,590	4,130	210	0.6	~18	1,460	5,690
Mold steel (NAK80, HPM1, P21) 38-43HRC	JC8118	~100	0.8	~14	1,290	3,100	~100	0.8	~18	1,180	4,250
		150	0.6	~14	1,290	2,840	150	0.6	~18	1,180	3,890
		210	0.4	~14	1,090	2,180	210	0.4	~18	1,000	3,000
Hardened die steel (SKD61, DAC, DHA) 42-52HRC	JC8118	~100	0.8	~14	990	1,980	~100	0.8	~18	910	2,730
		150	0.6	~14	990	1,780	150	0.6	~18	910	2,460
		210	0.4	~14	800	1,280	210	0.4	~18	730	1,750
Grey cast iron (FC250) 160-260HB	JC8118	~100	1.5	~14	1,990	5,970	~100	1.5	~18	1,820	8,190
		150	1.2	~14	1,990	5,970	150	1.2	~18	1,820	8,190
		210	0.8	~14	1,790	5,010	210	0.8	~18	1,640	6,890
Nodular cast iron (FCD700) 170-300HB	JC8118	~100	1	~14	1,690	5,070	~100	1	~18	1,550	6,980
		150	0.8	~14	1,690	4,730	150	0.8	~18	1,550	6,510
		210	0.6	~14	1,490	3,870	210	0.6	~18	1,360	5,300
Austenitic stainless steel (SUS304, 316, 317) 17Cr	JC8050	~100	0.8	~14	1,490	3,580	~100	0.8	~18	1,360	4,900
		150	0.6	~14	1,490	3,280	150	0.6	~18	1,360	4,490
		210	0.4	~14	1,290	2,580	210	0.4	~18	1,180	3,540
Ferritic & martensitic stainless steel (SUS403 420J2, 430) 13Cr	JC8118	~100	1	~14	1,690	4,060	~100	1	~18	1,550	5,580
		150	0.8	~14	1,690	3,720	150	0.8	~18	1,550	5,120
		210	0.6	~14	1,490	2,980	210	0.6	~18	1,360	4,080

Note

1. Please adjust cutting conditions according to machine rigidity or work rigidity. (the above table is guide for cutting on a #50 BT machine.)
2. In case of chatter occurring, recommended to reduce a_p or rpm and keep feed per tooth.
3. a_p should be reduced when using on low rigidity machine.
4. Use air blow.

SKS EXTREME
EXSKS/MEX Type

- Recommended cutting conditions
- MEX07 Modular Head type + MSN Shank

Material	Grade	Tool dia.(mm)				
		40/42				
		4N				
		ℓ (mm)	a _p (mm)	a _e (mm)	n (min ⁻¹)	V _f (mm/min)
Carbon steel (S50C, S55C) below 250HB	JC8050	~100	1	~23	1,430	8,580
		150	0.8	~23	1,430	8,010
		210	0.6	~23	1,270	6,600
Tool & die steel (SKD61, SKD11) below 255HB	JC8050	~100	1	~23	1,270	7,620
		150	0.8	~23	1,270	7,110
		210	0.6	~23	1,110	5,770
Mold steel (HPM7, PX5, P20) 30-36 HRC	JC8118	~100	1	~23	1,270	7,620
		150	0.8	~23	1,270	7,110
		210	0.6	~23	1,110	5,770
Mold steel (NAK80, HPM1, P21) 38-43HRC	JC8118	~100	0.8	~23	880	4,220
		150	0.6	~23	880	3,870
		210	0.4	~23	720	2,880
Hardened die steel (SKD61, DAC, DHA) 42-52HRC	JC8118	~100	0.8	~23	720	2,880
		150	0.6	~23	720	2,590
		210	0.4	~23	560	1,790
Grey cast iron (FC250) 160-260HB	JC8118	~100	1.5	~23	1,430	8,580
		150	1.2	~23	1,430	8,580
		210	0.8	~23	1,270	7,110
Nodular cast iron (FCD700) 170-300HB	JC8118	~100	1	~23	1,190	7,140
		150	0.8	~23	1,190	6,660
		210	0.6	~23	1,030	5,360
Austenitic stainless steel (SUS304, 316, 317) 17Cr	JC8050	~100	0.8	~23	1,030	4,940
		150	0.6	~23	1,030	4,530
		210	0.4	~23	880	3,520
Ferritic & martensitic stainless steel (SUS403 420J2, 430) 13Cr	JC8118	~100	1	~23	1,190	5,710
		150	0.8	~23	1,190	5,240
		210	0.6	~23	1,030	4,120

Note

1. Please adjust cutting conditions according to machine rigidity or work rigidity. (the above table is guide for cutting on a #50 BT machine.)
2. In case of chatter occurring, recommended to reduce a_p or rpm and keep feed per tooth.
3. a_p should be reduced when using on low rigidity machine.
4. Use air blow.

SKS EXTREME**EXSKS/MEX Type**

- Recommended cutting conditions
- EXSKS07 Endmill shank type

Material	Grade	Tool dia.(mm)									
		32					35				
		2N					3N				
		ℓ (mm)	a _p (mm)	a _e (mm)	n (min ⁻¹)	V _f (mm/min)	ℓ (mm)	a _p (mm)	a _e (mm)	n (min ⁻¹)	V _f (mm/min)
Carbon steel (S50C, S55C) below 250HB	JC8050	~70	0.8	~14	1,990	4,780	~90	0.8	~18	1,820	6,550
		~120	0.7	~14	1,790	3,940	~140	0.7	~18	1,640	5,410
		-	-	-	-	-	-	-	-	-	-
Tool & die steel (SKD61, SKD11) below 255HB	JC8050	~70	0.8	~14	1,790	4,300	~90	0.8	~18	1,640	5,900
		~120	0.7	~14	1,590	3,500	~140	0.7	~18	1,460	4,820
		-	-	-	-	-	-	-	-	-	-
Mold steel (HPM7, PX5, P20) 30-36 HRC	JC8118	~70	0.8	~14	1,790	4,300	~90	0.8	~18	1,640	5,900
		~120	0.7	~14	1,590	3,500	~140	0.7	~18	1,460	4,820
		-	-	-	-	-	-	-	-	-	-
Mold steel (NAK80, HPM1, P21) 38-43HRC	JC8118	~70	0.6	~14	1,290	2,580	~90	0.6	~18	1,180	3,540
		~120	0.5	~14	1,090	1,960	~140	0.5	~18	1,000	2,700
		-	-	-	-	-	-	-	-	-	-
Hardened die steel (SKD61, DAC, DHA) 42-52HRC	JC8118	~70	0.6	~14	990	1,780	~90	0.6	~18	910	2,460
		~120	0.5	~14	800	1,280	~140	0.5	~18	730	1,750
		-	-	-	-	-	-	-	-	-	-
Grey cast iron (FC250) 160-260HB	JC8118	~70	1.2	~14	1,990	4,780	~90	1.2	~18	1,820	6,550
		~120	1	~14	1,790	4,300	~140	1	~18	1,640	5,900
		-	-	-	-	-	-	-	-	-	-
Nodular cast iron (FCD700) 170-300HB	JC8118	~70	0.8	~14	1,690	4,060	~90	0.8	~18	1,550	5,580
		~120	0.6	~14	1,490	3,280	~140	0.6	~18	1,360	4,490
		-	-	-	-	-	-	-	-	-	-
Austenitic stainless steel (SUS304, 316, 317) 17Cr	JC8050	~70	0.6	~14	1,490	2,980	~90	0.6	~18	1,360	4,080
		~120	0.5	~14	1,290	2,320	~140	0.5	~18	1,180	3,190
		-	-	-	-	-	-	-	-	-	-
Ferritic & martensitic stainless steel (SUS403 420J2, 430) 13Cr	JC8118	~70	0.8	~14	1,690	3,380	~90	0.8	~18	1,550	4,650
		~120	0.7	~14	1,490	2,680	~140	0.7	~18	1,360	3,670
		-	-	-	-	-	-	-	-	-	-

Note

1. Please adjust cutting conditions according to machine rigidity or work rigidity. (the above table is guide for cutting on a #50 BT machine.)
2. In case of chatter occurring, recommended to reduce a_p or rpm and keep feed per tooth.
3. a_p should be reduced when using on low rigidity machine.
4. Use air blow.

SKS EXTREME
EXSKS/MEX Type
■ Recommended cutting conditions
● EXSKS07 Endmill shank type

Material	Grade	Tool dia.(mm)				
		40				
		4N				
		ℓ (mm)	a _p (mm)	a _e (mm)	n (min ⁻¹)	V _f (mm/min)
Carbon steel (S50C, S55C) below 250HB	JC8050	~90	0.8	~23	1,430	6,860
		~140	0.7	~23	1,350	5,940
		-	-	-	-	-
Tool & die steel (SKD61, SKD11) below 255HB	JC8050	~90	0.8	~23	1,270	6,100
		~140	0.7	~23	1,190	5,240
		-	-	-	-	-
Mold steel (HPM7, PX5, P20) 30-36 HRC	JC8118	~90	0.8	~23	1,270	6,100
		~140	0.7	~23	1,190	5,240
		-	-	-	-	-
Mold steel (NAK80, HPM1, P21) 38-43HRC	JC8118	~90	0.6	~23	880	3,520
		~140	0.5	~23	800	2,880
		-	-	-	-	-
Hardened die steel (SKD61, DAC, DHA) 42-52HRC	JC8118	~90	0.6	~23	720	2,590
		~140	0.5	~23	640	2,050
		-	-	-	-	-
Grey cast iron (FC250) 160-260HB	JC8118	~90	1.2	~23	1,430	6,860
		~140	1	~23	1,350	6,480
		-	-	-	-	-
Nodular cast iron (FCD700) 170-300HB	JC8118	~90	0.8	~23	1,190	5,710
		~140	0.6	~23	1,110	4,880
		-	-	-	-	-
Austenitic stainless steel (SUS304, 316, 317) 17Cr	JC8050	~90	0.6	~23	1,030	4,120
		~140	0.5	~23	950	3,420
		-	-	-	-	-
Ferritic & martensitic stainless steel (SUS403 420J2, 430) 13Cr	JC8118	~90	0.8	~23	1,190	4,760
		~140	0.7	~23	1,110	4,000
		-	-	-	-	-

Note

1. Please adjust cutting conditions according to machine rigidity or work rigidity. (the above table is guide for cutting on a #50 BT machine.)
2. In case of chatter occurring, recommended to reduce a_p or rpm and keep feed per tooth.
3. a_p should be reduced when using on low rigidity machine.
4. Use air blow.

SKS EXTREME**EXSKS/MEX Type**

- Recommended cutting conditions
- EXSKS07 Facemill type

Material	Grade	Tool dia.(mm)									
		50/52					63				
		5N					6N				
		ℓ (mm)	a _p (mm)	a _e (mm)	n (min ⁻¹)	V _f (mm/min)	ℓ (mm)	a _p (mm)	a _e (mm)	n (min ⁻¹)	V _f (mm/min)
Carbon steel (S50C, S55C) below 250HB	JC8050	~150	1.5	~33	950	7,130	~150	1.5	~46	760	6,840
		200	1.2	~33	950	6,180	200	1.2	~46	760	5,930
		250	1	~33	830	5,400	250	1	~46	660	5,150
		300	0.7	~33	760	4,180	300	0.7	~46	610	4,030
		350	-	-	-	-	350	0.5	~46	610	4,030
Tool & die steel (SKD61, SKD11) below 255HB	JC8050	~150	1.5	~33	830	6,230	~150	1.5	~46	660	5,940
		200	1.2	~33	830	5,400	200	1.2	~46	660	5,150
		250	1	~33	700	4,550	250	1	~46	560	4,370
		300	0.7	~33	640	3,520	300	0.7	~46	510	3,370
		350	-	-	-	-	350	0.5	~46	510	3,370
Mold steel (HPM7, PX5, P20) 30-36 HRC	JC8118	~150	1.5	~33	830	6,230	~150	1.5	~46	660	5,940
		200	1.2	~33	830	5,400	200	1.2	~46	660	5,150
		250	1	~33	700	4,550	250	1	~46	560	4,370
		300	0.7	~33	640	3,520	300	0.7	~46	510	3,370
		350	-	-	-	-	350	0.5	~46	510	3,370
Mold steel (NAK80, HPM1, P21) 38-43HRC	JC8118	~150	1.2	~33	700	4,550	~150	1.2	~46	560	4,370
		200	1	~33	700	3,850	200	1	~46	560	3,700
		250	0.7	~33	570	3,140	250	0.7	~46	450	2,970
		300	0.5	~33	510	2,550	300	0.5	~46	400	2,400
		350	-	-	-	-	350	-	-	-	-
Hardened die steel (SKD61, DAC, DHA) 42-52HRC	JC8118	~150	1	~33	570	2,850	~150	1	~46	450	2,700
		200	0.8	~33	570	2,570	200	0.8	~46	450	2,430
		250	0.6	~33	510	2,300	250	0.6	~46	400	2,160
		300	0.4	~33	450	1,800	300	0.4	~46	350	1,680
		350	-	-	-	-	350	-	-	-	-
Grey cast iron (FC250) 160-260HB	JC8118	~150	2	~33	950	7,130	~150	2	~46	760	6,840
		200	1.5	~33	950	6,180	200	1.5	~46	760	5,930
		250	1	~33	830	5,400	250	1	~46	660	5,150
		300	0.7	~33	760	4,180	300	0.7	~46	610	4,030
		350	-	-	-	-	350	0.5	~46	610	4,030
Nodular cast iron (FCD700) 170-300HB	JC8118	~150	1.5	~33	830	6,230	~150	1.5	~46	660	5,940
		200	1.2	~33	830	5,400	200	1.2	~46	660	5,150
		250	1	~33	700	4,550	250	1	~46	560	4,370
		300	0.7	~33	640	3,520	300	0.7	~46	510	3,370
		350	-	-	-	-	350	0.5	~46	510	3,370
Austenitic stainless steel (SUS304, 316, 317) 17Cr	JC8050	~150	1.2	~33	700	4,550	~150	1.2	~46	560	4,370
		200	1	~33	700	3,850	200	1	~46	560	3,700
		250	0.7	~33	570	3,140	250	0.7	~46	450	2,970
		300	0.5	~33	510	2,550	300	0.5	~46	400	2,400
		350	-	-	-	-	350	0.4	~46	400	2,400
Ferritic & martensitic stainless steel (SUS403 420J2, 430) 13Cr	JC8118	~150	1.5	~33	830	5,400	~150	1.5	~46	660	5,150
		200	1.2	~33	830	4,570	200	1.2	~46	660	4,360
		250	1	~33	700	3,850	250	1	~46	560	3,700
		300	0.7	~33	640	3,200	300	0.7	~46	510	3,060
		350	-	-	-	-	350	0.5	~46	510	3,060

Note

1. Please adjust cutting conditions according to machine rigidity or work rigidity. (the above table is guide for cutting on a #50 BT machine.)
2. In case of chatter occurring, recommended to reduce a_p or rpm and keep feed per tooth.
3. a_p should be reduced when using on low rigidity machine.
4. Use air blow.

SKS EXTREME
EXSKS/MEX Type

- Recommended cutting conditions
- EXSKS07 Facemill type

Material	Grade	Tool dia.(mm)				
		80				
		7N				
		ϕ (mm)	a_p (mm)	a_e (mm)	n (min ⁻¹)	V_f (mm/min)
Carbon steel (S50C, S55C) below 250HB	JC8050	~150	1.5	~63	600	6,300
		200	1.2	~63	600	5,460
		250	1	~63	520	4,730
		300	0.7	~63	480	3,700
		350	0.5	~63	480	3,700
Tool & die steel (SKD61, SKD11) below 255HB	JC8050	~150	1.5	~63	520	5,460
		200	1.2	~63	520	4,730
		250	1	~63	440	4,000
		300	0.7	~63	400	3,080
		350	0.5	~63	400	3,080
Mold steel (HPM7, PX5, P20) 30-36 HRC	JC8118	~150	1.5	~63	520	5,460
		200	1.2	~63	520	4,730
		250	1	~63	440	4,000
		300	0.7	~63	400	3,080
		350	0.5	~63	400	3,080
Mold steel (NAK80, HPM1, P21) 38-43HRC	JC8118	~150	1.2	~63	440	4,000
		200	1	~63	440	3,390
		250	0.7	~63	360	2,770
		300	0.5	~63	320	2,240
		350	-	-	320	2,240
Hardened die steel (SKD61, DAC, DHA) 42-52HRC	JC8118	~150	1	~63	360	2,520
		200	0.8	~63	360	2,270
		250	0.6	~63	320	2,020
		300	0.4	~63	280	1,570
		350	-	-	-	-
Grey cast iron (FC250) 160-260HB	JC8118	~150	2	~63	600	6,300
		200	1.5	~63	600	5,460
		250	1	~63	520	4,730
		300	0.7	~63	480	3,700
		350	0.5	~63	480	3,700
Nodular cast iron (FCD700) 170-300HB	JC8118	~150	1.5	~63	520	5,460
		200	1.2	~63	520	4,730
		250	1	~63	440	4,000
		300	0.7	~63	400	3,080
		350	0.5	~63	400	3,080
Austenitic stainless steel (SUS304, 316, 317) 17Cr	JC8050	~150	1.2	~63	440	4,000
		200	1	~63	440	3,390
		250	0.7	~63	360	2,770
		300	0.5	~63	320	2,240
		350	0.4	~63	320	2,240
Ferritic & martensitic stainless steel (SUS403 420J2, 430) 13Cr	JC8118	~150	1.5	~63	520	4,730
		200	1.2	~63	520	4,000
		250	1	~63	440	3,390
		300	0.7	~63	400	2,800
		350	0.5	~63	400	2,800

Note

1. Please adjust cutting conditions according to machine rigidity or work rigidity. (the above table is guide for cutting on a #50 BT machine.)
2. In case of chatter occurring, recommended to reduce a_p or rpm and keep feed per tooth.
3. a_p should be reduced when using on low rigidity machine.
4. Use air blow.

SKS EXTREME**EXSKS/MEX Type**

- Recommended cutting conditions
- EXSKS09 Type

Material	Grade	Tool dia.(mm)														
		50					50/52					63				
		3N					4N					4N				
		ℓ (mm)	a _p (mm)	n (min ⁻¹)	V _f (mm/min)	P _c (kW)	ℓ (mm)	a _p (mm)	n (min ⁻¹)	V _f (mm/min)	P _c (kW)	ℓ (mm)	a _p (mm)	n (min ⁻¹)	V _f (mm/min)	P _c (kW)
Carbon steel (S50C, S55C) below 250HB	JC7560 JC8050 (JC8118)	~150	2	950	5,700	9.3	~150	2	950	7,600	12.4	~150	2	750	6,000	12.3
		200	1.5	800	4,800	5.9	200	1.5	800	6,400	7.8	200	1.8	680	5,440	10.0
		250	1	650	2,925	2.4	250	1	650	3,900	3.2	250	1.5	600	4,800	7.4
		300	0.6	650	1,950	1.0	300	0.6	650	2,600	1.3	300	1	550	4,400	4.5
		350	—	—	—	—	350	—	—	—	—	350	0.6	550	3,300	2.0
400	—	—	—	—	400	—	—	—	—	400	0.4	550	2,200	0.9		
Tool & die steel (SKD61, SKD11) below 255HB	JC7560 JC8050 (JC8118)	~150	2	950	5,700	9.3	~150	2	950	7,600	12.4	~150	2	750	6,000	12.3
		200	1.5	800	4,800	5.9	200	1.5	800	6,400	7.8	200	1.8	680	5,440	10.0
		250	1	650	2,925	2.4	250	1	650	3,900	3.2	250	1.5	600	4,800	7.4
		300	0.6	650	1,950	1.0	300	0.6	650	2,600	1.3	300	1	550	4,400	4.5
		350	—	—	—	—	350	—	—	—	—	350	0.6	550	3,300	2.0
400	—	—	—	—	400	—	—	—	—	400	0.4	550	2,200	0.9		
Mold steel (HPM7, PX5, P20) 30-36 HRC	JC7560 JC8050 (JC8118)	~150	2	830	4,980	9.2	~150	2	830	6,640	12.3	~150	2	650	5,200	12.2
		200	1.5	700	4,200	5.9	200	1.5	700	5,600	7.8	200	1.8	580	4,640	9.8
		250	1	570	2,565	2.4	250	1	570	3,420	3.2	250	1.5	520	4,160	7.3
		300	0.6	570	1,710	1.0	300	0.6	570	2,280	1.3	300	1	460	3,680	4.3
		350	—	—	—	—	350	—	—	—	—	350	0.6	460	2,760	1.9
400	—	—	—	—	400	—	—	—	—	400	0.4	460	1,840	0.9		
Mold steel (NAK80, HPM1, P21) 38-43HRC	JC8118 (JC8050)	~150	1.5	700	2,100	5.1	~150	1.5	700	2,800	6.8	~150	1.5	550	2,200	6.8
		200	1	600	1,800	2.9	200	1	600	2,400	3.9	200	1.2	500	2,000	4.9
		250	0.7	490	1,470	1.7	250	0.7	490	1,960	2.2	250	1	440	1,760	3.6
		300	0.4	490	735	0.5	300	0.4	490	980	0.6	300	0.7	380	1,520	2.2
		350	—	—	—	—	350	—	—	—	—	350	0.5	380	1,520	1.6
400	—	—	—	—	400	—	—	—	—	400	—	—	—	—		
Hardened die steel (SKD61, DAC, DHA) 42-52HRC	JC8118	~150	1.5	510	1,530	5.0	~150	1.5	510	2,040	6.6	~150	1.5	400	1,600	6.6
		200	1	460	1,380	3.0	200	1	460	1,840	4.0	200	1.2	360	1,440	4.7
		250	0.7	420	1,260	1.9	250	0.7	420	1,680	2.5	250	1	320	1,280	3.5
		300	0.4	420	630	0.5	300	0.4	420	840	0.7	300	0.7	280	1,120	2.1
		350	—	—	—	—	350	—	—	—	—	350	0.5	280	1,120	1.5
400	—	—	—	—	400	—	—	—	—	400	—	—	—	—		
Grey cast iron (FC250, FC300) below 300HB	JC8118	~150	2.5	950	5,700	9.3	~150	2.5	950	7,600	12.4	~150	2.5	750	6,000	12.3
		200	2	800	4,800	6.2	200	2	800	6,400	8.3	200	2	680	5,440	8.9
		250	1.5	650	2,925	2.9	250	1.5	650	3,900	3.8	250	1.5	600	4,800	5.9
		300	1	650	1,950	1.3	300	1	650	2,600	1.7	300	1	550	4,400	3.6
		350	—	—	—	—	350	—	—	—	—	350	0.6	550	3,300	1.6
400	—	—	—	—	400	—	—	—	—	400	0.4	550	2,200	0.7		
Nodular cast iron (FCD500, FCD700) below 300HB	JC8118	~150	2.5	950	5,700	9.3	~150	2.5	950	7,600	12.4	~150	2.5	750	6,000	12.3
		200	2	800	4,800	6.2	200	2	800	6,400	8.3	200	2	680	5,440	8.9
		250	1.5	650	2,925	2.9	250	1.5	650	3,900	3.8	250	1.5	600	4,800	5.9
		300	1	650	1,950	1.3	300	1	650	2,600	1.7	300	1	550	4,400	3.6
		350	—	—	—	—	350	—	—	—	—	350	0.6	550	3,300	1.6
400	—	—	—	—	400	—	—	—	—	400	0.4	550	2,200	0.7		
Stainless steel (SUS304) below 250HB	JC8050 (JC7560)	~150	2	950	4,275	11.1	~150	2	950	5,700	14.8	~150	2	750	4,500	14.7
		200	1.5	800	3,600	7.0	200	1.5	800	4,800	9.4	200	1.8	680	4,080	12.0
		250	1	650	1,950	2.5	250	1	650	2,600	3.4	250	1.5	600	3,600	8.8
		300	0.6	650	1,950	1.5	300	0.6	650	2,600	2.0	300	1	550	2,640	4.3
		350	—	—	—	—	350	—	—	—	—	350	0.6	550	2,200	2.2
400	—	—	—	—	400	—	—	—	—	400	0.4	550	2,200	1.4		

Note

1. Please adjust cutting conditions according to machine rigidity or work rigidity. (the above table is guide for cutting on a #50 BT machine.)
2. In case of chatter occurring, recommended to reduce a_p or rpm and keep feed per tooth.
3. a_p should be reduced when using on low rigidity machine.
4. Use air blow.
5. a_p ≤ 2mm when using PL insert.

SKS EXTREME

EXSKS/MEX Type

- Recommended cutting conditions
- EXSKS09 Type

Material	Grade	Tool dia.(mm)														
		63/66					80					100				
		5N					6N					7N				
		ℓ (mm)	ap (mm)	n (min ⁻¹)	Vf (mm/min)	Pc (kW)	ℓ (mm)	ap (mm)	n (min ⁻¹)	Vf (mm/min)	Pc (kW)	ℓ (mm)	ap (mm)	n (min ⁻¹)	Vf (mm/min)	Pc (kW)
Carbon steel (S50C, S55C) below 250HB	JC7560 JC8050 (JC8118)	~150	2	750	7,500	15.4	~150	2	600	7,200	18.7	~150	2	480	6,720	21.8
		200	1.8	680	6,800	12.5	200	1.8	540	6,480	15.2	200	2	430	6,020	19.6
		250	1.5	600	6,000	9.2	250	1.8	480	5,760	13.5	250	2	380	5,320	17.3
		300	1	550	5,500	5.6	300	1.5	440	5,280	10.3	300	1.5	350	4,900	11.9
		350	0.6	550	4,125	2.5	350	1	440	5,280	6.9	350	1.5	350	4,900	11.9
		400	0.4	550	2,750	1.1	400	0.6	440	3,960	3.1	400	1	350	4,900	8.0
Tool & die steel (SKD61, SKD11) below 255HB	JC7560 JC8050 (JC8118)	~150	2	750	7,500	15.4	~150	2	600	7,200	18.7	~150	2	480	6,720	21.8
		200	1.8	680	6,800	12.5	200	1.8	540	6,480	15.2	200	2	430	6,020	19.6
		250	1.5	600	6,000	9.2	250	1.8	480	5,760	13.5	250	2	380	5,320	17.3
		300	1	550	5,500	5.6	300	1.5	440	5,280	10.3	300	1.5	350	4,900	11.9
		350	0.6	550	4,125	2.5	350	1	440	5,280	6.9	350	1.5	350	4,900	11.9
		400	0.4	550	2,750	1.1	400	0.6	440	3,960	3.1	400	1	350	4,900	8.0
Mold steel (HPM7, PX5, P20) 30-36 HRC	JC7560 JC8050 (JC8118)	~150	2	650	6,500	15.2	~150	2	520	6,240	18.5	~150	2	410	5,740	21.3
		200	1.8	580	5,800	12.2	200	1.8	470	5,640	15.1	200	2	370	5,180	19.2
		250	1.5	520	5,200	9.1	250	1.8	420	5,040	13.5	250	2	330	4,620	17.2
		300	1	460	4,600	5.4	300	1.5	360	4,320	9.6	300	1.5	280	3,920	10.9
		350	0.6	460	3,450	2.4	350	1	360	4,320	6.4	350	1.5	280	3,920	10.9
		400	0.4	460	2,300	1.1	400	0.6	360	3,240	2.9	400	1	280	3,920	7.3
Mold steel (NAK80, HPM1, P21) 38-43HRC	JC8118 (JC8050)	~150	1.5	550	2,750	8.4	~150	1.5	430	2,580	10.1	~150	1.5	350	2,450	11.9
		200	1.2	500	2,500	6.1	200	1.2	390	2,340	7.3	200	1.5	310	2,170	10.6
		250	1	440	2,200	4.5	250	1.2	340	2,040	6.4	250	1.2	280	1,960	7.6
		300	0.7	380	1,900	2.7	300	1	300	1,800	4.7	300	1	250	1,750	5.7
		350	0.5	380	1,900	1.9	350	0.7	300	1,800	3.3	350	1	250	1,750	5.7
		400	—	—	—	—	400	0.4	300	1,800	1.9	400	0.7	250	1,750	4.0
Hardened die steel (SKD61, DAC, DHA) 42-52HRC	JC8118	~150	1.5	400	2,000	8.2	~150	1.5	320	1,920	10.0	~150	1.5	250	1,750	11.4
		200	1.2	360	1,800	5.9	200	1.2	290	1,740	7.2	200	1.5	230	1,610	10.5
		250	1	320	1,600	4.4	250	1.2	260	1,560	6.5	250	1.2	200	1,400	7.3
		300	0.7	280	1,400	2.7	300	1	220	1,320	4.6	300	1	180	1,260	5.5
		350	0.5	280	1,400	1.9	350	0.7	220	1,320	3.2	350	1	180	1,260	5.5
		400	—	—	—	—	400	0.4	220	1,320	1.8	400	0.7	180	1,260	3.8
Grey cast iron (FC250, FC300) below 300HB	JC8118	~150	2.5	750	7,500	15.4	~150	2.5	600	7,200	18.7	~150	2.5	480	6,720	21.8
		200	2	680	6,800	11.1	200	2	540	6,480	13.5	200	2.5	430	6,020	19.6
		250	1.5	600	6,000	7.4	250	2	480	5,760	12.0	250	2	380	5,320	13.8
		300	1	550	5,500	4.5	300	1.5	440	5,280	8.2	300	2	350	4,900	12.7
		350	0.6	550	4,125	2.0	350	1	440	5,280	5.5	350	1.5	350	4,900	9.6
		400	0.4	550	2,750	0.9	400	0.6	440	3,960	2.5	400	1	350	4,900	6.4
Nodular cast iron (FCD500, FCD700) below 300HB	JC8118	~150	2.5	750	7,500	15.4	~150	2.5	600	7,200	18.7	~150	2.5	480	6,720	21.8
		200	2	680	6,800	11.1	200	2	540	6,480	13.5	200	2.5	430	6,020	19.6
		250	1.5	600	6,000	7.4	250	2	480	5,760	12.0	250	2	380	5,320	13.8
		300	1	550	5,500	4.5	300	1.5	440	5,280	8.2	300	2	350	4,900	12.7
		350	0.6	550	4,125	2.0	350	1	440	5,280	5.5	350	1.5	350	4,900	9.6
		400	0.4	550	2,750	0.9	400	0.6	440	3,960	2.5	400	1	350	4,900	6.4
Stainless steel (SUS304) below 250HB	JC8050 (JC7560)	~150	2	750	5,625	18.4	~150	2	600	5,400	22.5	~150	2	480	5,040	26.2
		200	1.8	680	5,100	15.0	200	1.8	540	4,860	18.2	200	2	430	4,515	23.5
		250	1.5	600	4,500	11.1	250	1.8	480	4,320	16.2	250	2	380	3,990	20.7
		300	1	550	3,300	5.4	300	1.5	440	3,960	12.4	300	1.5	350	3,675	14.3
		350	0.6	550	2,750	2.7	350	1	440	3,168	6.6	350	1.5	350	3,675	14.3
		400	0.4	550	2,750	1.8	400	0.6	440	2,640	3.3	400	1	350	3,675	9.6

Note

1. Please adjust cutting conditions according to machine rigidity or work rigidity. (the above table is guide for cutting on a #50 BT machine.)
2. In case of chatter occurring, recommended to reduce ap or rpm and keep feed per tooth.
3. ap should be reduced when using on low rigidity machine.
4. Use air blow.
5. ap ≤ 2mm when using PL insert.

SKS EXTREME**EXSKS/MEX Type**

■ Recommended cutting conditions

● EXSKS09 Type

Material	Grade	Tool dia.(mm)									
		125					160				
		8N					9N				
		φ (mm)	a _p (mm)	n (min ⁻¹)	V _f (mm/min)	P _c (kW)	φ (mm)	a _p (mm)	n (min ⁻¹)	V _f (mm/min)	P _c (kW)
Carbon steel (S50C, S55C) below 250HB	JC7560 JC8050 (JC8118)	~150	2	380	6,080	24.7	~150	2	300	5,400	28.1
		200	2	340	5,440	22.1	200	2	270	4,860	25.3
		250	2	300	4,800	19.5	250	2	240	4,320	22.5
		300	2	280	4,480	18.2	300	2	220	3,960	20.6
		350	1.5	280	4,480	13.7	350	2	220	3,960	20.6
		400	1.5	280	4,480	13.7	400	1.5	220	3,960	15.4
Tool & die steel (SKD61, SKD11) below 255HB	JC7560 JC8050 (JC8118)	~150	2	380	6,080	24.7	~150	2	300	5,400	28.1
		200	2	340	5,440	22.1	200	2	270	4,860	25.3
		250	2	300	4,800	19.5	250	2	240	4,320	22.5
		300	2	280	4,480	18.2	300	2	220	3,960	20.6
		350	1.5	280	4,480	13.7	350	2	220	3,960	20.6
		400	1.5	280	4,480	13.7	400	1.5	220	3,960	15.4
Mold steel (HPM7, PX5, P20) 30-36 HRC	JC7560 JC8050 (JC8118)	~150	2	330	5,280	24.5	~150	2	260	4,680	27.8
		200	2	300	4,800	22.3	200	2	230	4,140	24.6
		250	2	260	4,160	19.3	250	2	210	3,780	22.5
		300	2	230	3,680	17.1	300	2	180	3,240	19.3
		350	1.5	230	3,680	12.8	350	2	180	3,240	19.3
		400	1.5	230	3,680	12.8	400	1.5	180	3,240	14.4
Mold steel (NAK80, HPM1, P21) 38-43HRC	JC8118 (JC8050)	~150	1.5	280	2,240	13.7	~150	1.5	220	1,980	15.4
		200	1.5	250	2,000	12.2	200	1.5	200	1,800	14.0
		250	1.5	220	1,760	10.7	250	1.5	180	1,620	12.6
		300	1.5	200	1,600	9.8	300	1.5	150	1,350	10.5
		350	1	200	1,600	6.5	350	1.5	150	1,350	10.5
		400	1	200	1,600	6.5	400	1	150	1,350	7.0
Hardened die steel (SKD61, DAC, DHA) 42-52HRC	JC8118	~150	1.5	200	1,600	13.0	~150	1.5	160	1,440	15.0
		200	1.5	180	1,440	11.7	200	1.5	150	1,350	14.0
		250	1.5	160	1,280	10.4	250	1.5	130	1,170	12.2
		300	1.5	140	1,120	9.1	300	1.5	110	990	10.3
		350	1	140	1,120	6.1	350	1.5	110	990	10.3
		400	1	140	1,120	6.1	400	1	110	990	6.9
Grey cast iron (FC250, FC300) below 300HB	JC8118	~150	2.5	380	6,080	24.7	~150	2.5	300	5,400	28.1
		200	2.5	340	5,440	22.1	200	2.5	270	4,860	25.3
		250	2.5	300	4,800	19.5	250	2.5	240	4,320	22.5
		300	2	280	4,480	14.6	300	2.5	220	3,960	20.6
		350	1.5	280	4,480	10.9	350	2	220	3,960	16.5
		400	1.5	280	4,480	10.9	400	1.5	220	3,960	12.4
Nodular cast iron (FCD500, FCD700) below 300HB	JC8118	~150	2.5	380	6,080	24.7	~150	2.5	300	5,400	28.1
		200	2.5	340	5,440	22.1	200	2.5	270	4,860	25.3
		250	2.5	300	4,800	19.5	250	2.5	240	4,320	22.5
		300	2	280	4,480	14.6	300	2.5	220	3,960	20.6
		350	1.5	280	4,480	10.9	350	2	220	3,960	16.5
		400	1.5	280	4,480	10.9	400	1.5	220	3,960	12.4
Stainless steel (SUS304) below 250HB	JC8050 (JC7560)	~150	2	380	4,560	29.6	~150	2	300	4,050	33.7
		200	2	340	4,080	26.5	200	2	270	3,645	30.3
		250	2	300	3,600	23.4	250	2	240	3,240	27.0
		300	2	280	3,360	21.8	300	2	220	2,970	24.7
		350	1.5	280	3,360	16.4	350	2	220	2,970	24.7
		400	1.5	280	3,360	16.4	400	1.5	220	2,970	18.5

Note

1. Please adjust cutting conditions according to machine rigidity or work rigidity. (the above table is guide for cutting on a #50 BT machine.)
2. In case of chatter occurring, recommended to reduce ap or rpm and keep feed per tooth.
3. ap should be reduced when using on low rigidity machine.
4. Use air blow.
5. ap ≤ 2mm when using PL insert.

QM MAX GII **GMX/MXG Type**

Achieving high metal removal rates! High efficiency machining for versatile applications



Q=317cm³/min
(when using Dc50-7N)

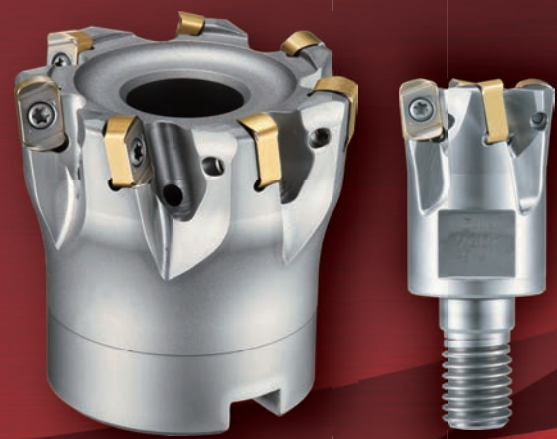

Feature 1

Optimized cutting edge for a wide range of applications



ENMU Type
For high feed with chipbreaker

Double sided insert



ENMQ Type
For hard materials

Feature 2

Economical double sided insert with 4 cutting edges
For various types of materials ; Carbon steel, Hardened material <upto 62HRC>, Stainless steel, Titanium alloy

● **Line up**



ENMU100412ZER-SL

- Low cutting force
- Sharp cutting edge
- Grade C7550, JC7518
- DS118, DS150

ENMU100412ZER-PH

- For general applications
- Grade JC8118, JC8050, JC7560

ENMU100312ZER-HL

- For hardened materials up to 60HRC
- enhanced cutting edge strength but retains sharpness
- Grade DH102

ENMQ100312ZER

- Flat top insert
- Grade DH102
- For hardened materials over 60HRC

● **Insert grades**

Iso	P					M					K				S				H		
	P01	P10	P20	P30	P40	M01	M10	M20	M30	M40	K01	K10	K20	K30	S01	S10	S20	S30	H01	H10	H20
Range																	DS118				
																	DS150				
			JC8118					JC8118			DH102		JC8118				DH102				DH102
			JC8050					JC8050					JC8050				JC8118				JC8118
			JC7518					JC7518					JC7518				JC8050				JC7518
			JC7550					JC7550					JC7550				JC7518				JC7518
		JC7560					JC7560					JC7560				JC7550				JC7550	
												JC7560				JC7560				JC7560	

QM MAX GII **GMX/MXG Type**

■ **Facemill Type**

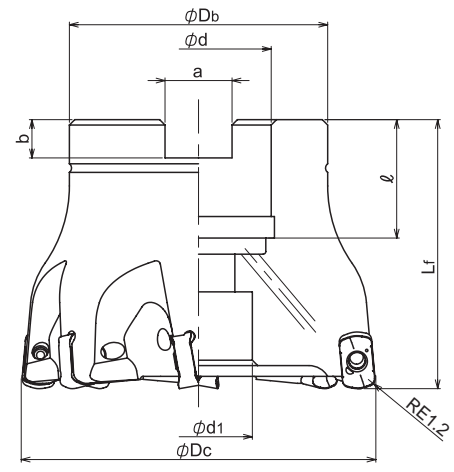
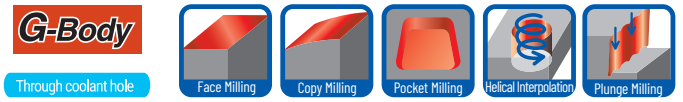

Cat.No	Stock	No. of inserts	Dimensions (mm)							Weight (kg)	Inserts	
			ϕD_c	Lf	ϕD_b	ϕd	ϕd_1	a	b			ℓ
GMX-7050R-22	●	7	50	50	40	22	17	10.4	6.3	20	0.35	ENMU100412ZER-**, ENM*100312ZER-**
GMX-7052R-22	●		52									
GMX-7063R-22	●		63		48	27	20	12.4	7	22	0.64	
GMX-7066R-27	●		66								0.66	

Screw	Torque(N.m)	Wrench
TSW-2567H	1.1	A-08

QM MAX GII **GMX/MXG Type**

■ Endmill Shank Type

Through coolant hole

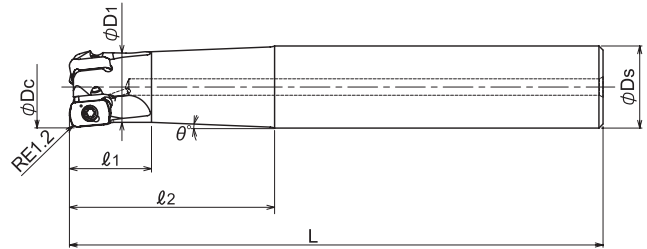

Cat.No	Stock	No. of inserts	Dimensions (mm)						theta° taper angle	Inserts
			phi Dc	l1	l2	L	phi D1	phi Ds		
GMX-2016-30-S16	●	2	16	16	30	100	14	16	3.5°	ENMU100412ZER-**-**; ENM*100312ZER-**-**
GMX-2016-50-S16	●				50	150			1.2°	
GMX-3020-50-S20	●	3	20	20	130	17.2	20	2.3°		
GMX-3020-80-S20	●				80			160	1°	
GMX-4025-60-S25	●	4	25	25	60	140	22	25	2°	
GMX-4025-100-S25	●				100				180	
GMX-5032-70-S32	●	5	32	30	70	150	29	32	1.5°	
GMX-5032-120-S32	●				120				200	

Screw	Torque(N.m)	Wrench
TSW-2567H	1.1	A-08

QM MAX GII **GMX/MXG Type**

■ **Modular Head Type**



Through coolant hole

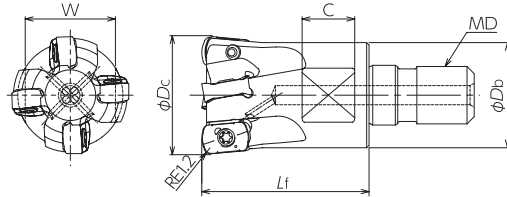

Cat.No	Stock	No. of inserts	Dimensions (mm)						Inserts	
			φDc	Lf	φDb	MD	C	W		
MXG-2016-M8	●	2	16	23	14	M8	8	12	ENMU100412ZER-**; ENM*100312ZER-**	
MXG-2017-M8	●		17			M8				
MXG-3020-M10	●	3	20	30	18	M10	9	14		
MXG-3021-M10	●		21			M10				
MXG-3025-M12	●	4	25	35	22	M12	11	19		
MXG-4025-M12	●		26			M12				
MXG-4026-M12	●					22.5				M12
MXG-4028-M12	●					23.6				M12
MXG-5030-M16	●	5	30	43	27	M16	12	22		
MXG-5032-M16	●		32			29				M16
MXG-5035-M16	●		35							M16
MXG-6040-M16	●	6	40	32	32	M16	14	26		
MXG-6042-M16	●		42			M16				

Screw	Torque(N.m)	Wrench
TSW-2567H	1.1	A-08

QM MAX GII

GMX/MXG Type

■ **Insert**

ENMU100412ZER-PH



ENMU100412ZER-SL



ENMU100312ZER-HL



ENMQ100312ZER

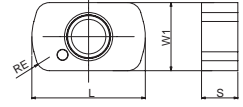
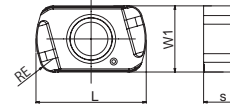
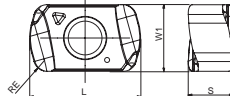
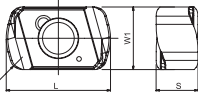
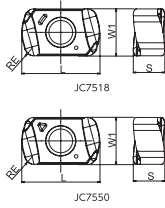

Cat.No	Tolerance	PVD Coating							Dimensions (mm)				
		DH102	JC7518	JC7550	JC7560	JC8050	JC8118	DS118	DS150	RE	L	W1	S
ENMU100412ZER-PH	M				●	●	●			1.2	10	6	4
ENMU100412ZER-SL			●	●				●	●				3.2
ENMU100312ZER-HL		●											
ENMQ100312ZER		●											

GRADE MARKING

ENMU100412ZER-PH

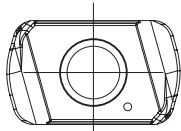

JC8118

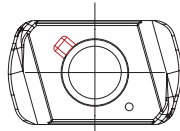

JC8050

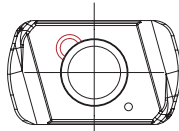

JC7560

ENMU100412ZER-SL

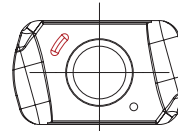

JC7518/DS1118

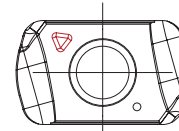

JC7550/DS150

QM MAX GII

GMX/MXG Type

■ Insert selection guide

Materials	Grade	Cat.No.			
		ENMU100412ZER-PH For general milling	ENMU100412ZER-SL Low cutting force	ENMU100312ZER-HL For Hardened materials	ENMQ100312ZER Flat top insert
Chip breaker					
Carbon steel (S50C, S55C) below 250HB	JC8118	○			
	JC8050	◎			
	JC7560	●			
	JC7550				
	JC7518		☆		
	DH102				
	DS118				
	DS150				
Tool & die steel (SKD61, SKD11) below 255HB	JC8118	○			
	JC8050	◎			
	JC7560	●			
	JC7550				
	JC7518		☆		
	DH102				
	DS118				
	DS150				
Mold steel HPM7, PX5, P20) 30 - 36HRC	JC8118	○			
	JC8050	◎			
	JC7560	●			
	JC7550				
	JC7518		☆		
	DH102				
	DS118				
	DS150				
Mold steel (NAK80, HPM1, P21) 38 - 43HRC	JC8118	◎			
	JC8050	●			
	JC7560				
	JC7550				
	JC7518		☆		
	DH102				
	DS118				
	DS150				
Hardened die steel (SKD61, DAC, DHA) 42 - 52HRC	JC8118	◎			
	JC8050				
	JC7560				
	JC7550				
	JC7518		☆		
	DH102			●	
	DS118				
	DS150				
Hardened die steel (SKD11, SLD, DC11) 55 - 62HRC	JC8118	×			
	JC8050	×			
	JC7560	×			
	JC7550		×		
	JC7518		×		
	DH102			○	◎
	DS118				
	DS150				
Grey cast iron (FC, FCD) below 300HB	JC8118	◎			
	JC8050	○			
	JC7560	●			
	JC7550				
	JC7518				
	DH102				
	DS118				
	DS150				
Stainless steel (SUS304) below 250HB	JC8118	●			
	JC8050				
	JC7560				
	JC7550		○		
	JC7518				
	DH102				
	DS118				
	DS150		◎		
Titanium alloy (Ti-6Al-4V)	JC8118	●			
	JC8050				
	JC7560				
	JC7550		○		
	JC7518				
	DH102				
	DS118				
	DS150		◎		
Heat resistant alloy (INCO718)	JC8118	●			
	JC8050				
	JC7560				
	JC7550				
	JC7518		○		
	DH102				
	DS118			◎	
	DS150				

◎ : First choice ○ : For general milling ● : For unstable milling ☆ : For light cutting resistance × : Not recommended

QM MAX GII

GMX/MXG Type

Definition of Corner Shape for Programming

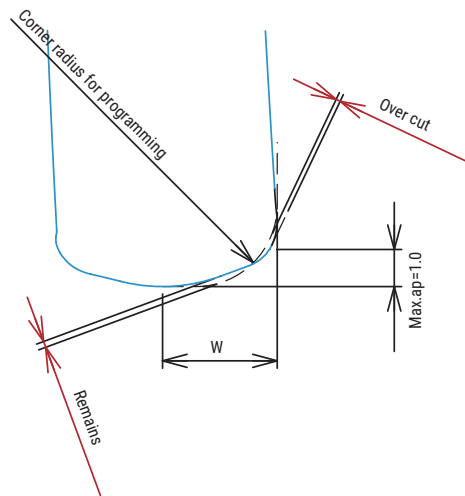

Cat.No.	W	Corner radius for programming	Remains	Over cut
ENMU100412ZER-PH ENMU100412ZER-SL	3.1	1.0	0.51	0
		1.5 (Standard)	0.36	0
		2.0	0.22	0.05

(mm)

Cat.No.	W	Corner radius for programming	Remains	Over cut
ENMU100312ZER-HL ENMQ100312ZER	3.3	1.0	0.55	0
		1.5 (Standard)	0.41	0
		2.0	0.26	0.04

(mm)

QM MAX GII

GMX/MXG Type

Recommended Data for Profile Milling

Ramping

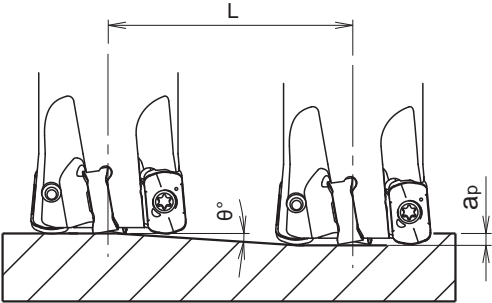

Helical interpolation

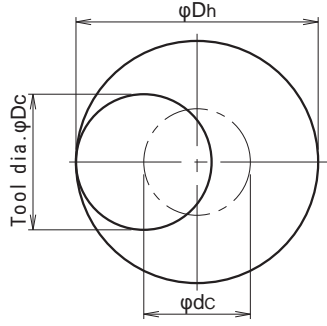

● Calculation of tool pass dia.

$$\varphi_{Dc} = \varphi_{Dh} - \varphi_{Dc}$$
 Tool pass dia. Bore dia. Tool dia.

- Depth of cut per one circuit should not exceed max. depth of cut Ap
- Down cutting is recommended, tool pass rotation should be counterclockwise

- In case of ramping and helical interpolation, apply 70% or less feed (Vf) from standard cutting condition table
- In case of drilling, apply 50% or less Z axis feed (F) from standard cutting condition table
- Long consecutive chips may result in case of drilling, confirm safe operating conditions

Cat.No.	Tool dia.	Effective Cutting dia.		Max. depth of cut: ap	Ramping	
		Insert			Ramping Max. ramping Angle θ	Max. depth of cut (ap) Total cutting length:L (mm)
		ENMU100412ZER-***	ENM***100312ZER-***			
MXG-2016-M8	16	10.1	9.6	0.7	1°36'	25.1
MXG-2017-M8	17	11	10.5	0.7	1°36'	25.1
MXG-3020-M10	20	13.9	13.5	1	1°30'	38.2
MXG-3021-M10	21	14.9	14.5	1	1°30'	38.2
MXG-*025-M12	25	18.9	18.4	1	1°12'	47.7
MXG-4026-M12	26	19.9	19.4	1	1°12'	47.7
MXG-5030-M16	30	23.9	23.4	1	0°54'	63.6
MXG-5032-M16	32	25.8	25.4	1	0°54'	63.6
MXG-5035-M16	35	28.8	28.4	1	0°42'	81.8
MXG-6040-M16	40	33.8	33.4	1	0°30'	114.5
MXG-6042-M16	42	35.8	35.4	1	0°30'	114.5
GMX-2016-**-S16	16	10.1	9.6	0.7	1°36'	25.1
GMX-3020-**-S20	20	13.9	13.5	1	1°30'	38.2
GMX-4025-**-S25	25	18.9	18.4	1	1°12'	47.7
GMX-5032-**-S32	32	25.8	25.4	1	0°54'	63.6
GMX-7050R-**	50	43.8	43.4	1	0°24'	143.2
GMX-7052R-22	52	45.8	45.4	1	0°24'	143.2
GMX-7063R-**	63	56.8	56.4	1	0°18'	190.9
GMX-7066R-**	66	59.8	59.4	1	0°18'	190.9

Cat.No.	Tool dia.	Helical interpolation			Max.drilling depth : Z	
		Min.Bore dia.		Max. Bore dia.	Insert	
		ENMU100412ZER-***	ENM***100312ZER-***		ENMU100412ZER-***	ENM***100312ZER-***
MXG-2016-M8	16	22	21	30	0.3	0.2
MXG-2017-M8	17	24	23	32	0.3	0.2
MXG-3020-M10	20	30	29	38	0.4	0.2
MXG-3021-M10	21	32	31	40	0.4	0.2
MXG-*025-M12	25	40	39	48	0.5	0.3
MXG-4026-M12	26	42	41	50	0.5	0.3
MXG-5030-M16	30	50	49	58	0.6	0.4
MXG-5032-M16	32	54	53	62	0.6	0.4
MXG-5035-M16	35	60	59	68	0.6	0.4
MXG-6040-M16	40	70	69	78	0.7	0.5
MXG-6042-M16	42	74	73	82	0.7	0.5
GMX-2016-**-S16	16	22	21	30	0.3	0.2
GMX-3020-**-S20	20	30	29	38	0.4	0.2
GMX-4025-**-S25	25	40	39	48	0.5	0.3
GMX-5032-**-S32	32	54	53	62	0.6	0.4
GMX-7050R-**	50	90	89	98	0.8	0.6
GMX-7052R-22	52	94	93	102	0.8	0.6
GMX-7063R-**	63	116	115	124	0.8	0.6
GMX-7066R-**	66	122	121	130	0.8	0.6

QM MAX GII**GMX/MXG Type**

■ Recommended cutting conditions

● Modular Head Type + MSN shank

Material	Cat.No.	Grade	Tool dia.(mm)									
			16/17					20/21/28				
			2N					3N				
			ℓ (mm)	a_p (mm)	a_e (mm)	n (min ⁻¹)	V_f (mm/min)	ℓ (mm)	a_p (mm)	a_e (mm)	n (min ⁻¹)	V_f (mm/min)
Carbon steel (S50C, S55C) below 250HB	ENMU 100412 ZER-PH	JC8050 (JC7560)	~50	0.7	~10	3,580	8,590	~60	0.8	~14	2,860	10,300
			80	0.6	~10	3,580	8,590	100	0.6	~14	2,860	10,300
			120	0.6	~10	3,180	7,630	140	0.6	~14	2,550	9,180
Tool & die steel (SKD61, SKD11) below 255HB	ENMU 100412 ZER-PH	JC8050 (JC7560)	~50	0.7	~10	3,580	8,590	~60	0.8	~14	2,860	10,300
			80	0.6	~10	3,580	8,590	100	0.6	~14	2,860	10,300
			120	0.6	~10	3,180	7,630	140	0.6	~14	2,550	9,180
Mold steel (HPM7, PX5, P20) 30-36 HRC	ENMU 100412 ZER-PH	JC8050 (JC7560)	~50	0.7	~10	3,180	7,630	~60	0.8	~14	2,550	9,180
			80	0.6	~10	3,180	7,630	100	0.6	~14	2,550	9,180
			120	0.6	~10	2,590	6,220	140	0.6	~14	2,070	7,450
Mold steel (NAK80, HPM1, P21) 38-43HRC	ENMU 100412 ZER-PH	JC8118 (JC8050)	~50	0.6	~10	1,890	4,160	~60	0.6	~14	1,510	4,980
			80	0.5	~10	1,690	3,040	100	0.5	~14	1,350	3,650
			120	0.5	~10	1,590	2,860	140	0.5	~14	1,270	3,430
Hardened die steel (SKD61, DAC, DHA) 42-52HRC	ENMU100412 ZER-PH (ENMU100412 ZER-SL)	JC8118 (JC7518)	~50	0.6	~10	1,890	4,160	~60	0.6	~14	1,510	4,980
			80	0.5	~10	1,690	3,040	100	0.5	~14	1,350	3,650
			120	0.5	~10	1,590	2,860	140	0.5	~14	1,270	3,430
Hardened die steel (SKD11, SLD, DC11) 55-62HRC	ENMQ100312 ZER (ENMU100312 ZER-HL)	DH102	~50	0.2	~10	1,590	950	~60	0.2	~14	1,270	1,140
			80	0.15	~10	1,390	700	100	0.15	~14	1,110	830
			120	0.1	~10	1,290	650	140	0.1	~14	1,030	770
Grey cast iron (FC250) 160-260HB	ENMU 100412 ZER-PH	JC8118 (JC8050)	~50	0.7	~10	3,980	11,940	~60	1	~14	3,180	14,310
			80	0.7	~10	3,980	11,940	100	0.8	~14	3,180	14,310
			120	0.6	~10	3,580	8,590	140	0.6	~14	2,860	10,300
Nodular cast iron (FCD700) 170-300HB	ENMU 100412 ZER-PH	JC8118 (JC8050)	~50	0.7	~10	3,980	11,940	~60	1	~14	3,180	14,310
			80	0.7	~10	3,980	11,940	100	0.8	~14	3,180	14,310
			120	0.6	~10	3,580	8,590	140	0.6	~14	2,860	10,300
Austenitic stainless steel (SUS304, 316, 317) 17Cr	ENMU 100412 ZER-SL	JC7550 (JC7518)	~50	0.6	~10	2,390	4,780	~60	0.6	~14	1,910	5,730
			80	0.5	~10	2,390	4,780	100	0.5	~14	1,910	5,730
			120	0.5	~10	1,990	3,180	140	0.5	~14	1,590	3,820
Precipitation hardening stainless steel (SUS630)	ENMU100412 ZER-SL ENMU100412 ZER-PH	JC7550 (JC8050)	~50	0.5	~10	1,990	2,790	~60	0.5	~14	1,590	3,340
			80	0.4	~10	1,990	2,790	100	0.4	~14	1,590	3,340
			120	0.4	~10	1,790	2,150	140	0.4	~14	1,430	2,570
Duplex stainless steel (S32750)	ENMU100412 ZER-SL ENMU100412 ZER-PH	JC7550 (JC8050)	~50	0.6	~10	1,990	1,190	~60	0.6	~14	1,590	1,430
			80	0.5	~10	1,990	1,190	100	0.5	~14	1,590	1,430
			120	0.5	~10	1,790	720	140	0.5	~14	1,430	860
Titanium alloy (Ti-6Al-4V) 35-43HRC	ENMU 100412 ZER-SL	DS150 (DS118)	~50	0.5	~10	1,190	1,670	~60	0.5	~14	950	2,000
			80	0.4	~10	1,190	1,670	100	0.4	~14	950	2,000
			120	0.4	~10	990	1,190	140	0.4	~14	800	1,440
Heat resistant alloy (INCO718) 35-43HRC	ENMU 100412 ZER-SL	DS118 (DS150)	~50	0.5	~10	600	360	~60	0.5	~14	480	430
			80	0.3	~10	600	360	100	0.3	~14	480	430
			120	0.2	~10	600	360	140	0.2	~14	480	430

Note

1. Please adjust cutting conditions according to machine rigidity or work rigidity.
2. In case of chatter occurring, recommended to reduce a_p or rpm and keep feed per tooth.
3. a_p should be reduced when using on low rigidity machine.
4. Use air blow.

QM MAX GII**GMX/MXG Type**

■ Recommended cutting conditions

● Modular Head Type + MSN shank

Material	Cat.No.	Grade	Tool dia.(mm)									
			25					25/26				
			3N					4N				
			ℓ (mm)	ap (mm)	ae (mm)	n (min ⁻¹)	Vf (mm/min)	ℓ (mm)	ap (mm)	ae (mm)	n (min ⁻¹)	Vf (mm/min)
Carbon steel (S50C, S55C) below 250HB	ENMU 100412 ZER-PH	JC8050 (JC7560)	~75	0.8	~19	2,290	8,240	~75	0.8	~19	2,290	10,990
			125	0.6	~19	2,290	8,240	125	0.6	~19	2,290	10,990
			175	0.6	~19	2,040	7,340	175	0.6	~19	2,040	9,790
Tool & die steel (SKD61, SKD11) below 255HB	ENMU 100412 ZER-PH	JC8050 (JC7560)	~75	0.8	~19	2,290	8,240	~75	0.8	~19	2,290	10,990
			125	0.6	~19	2,290	8,240	125	0.6	~19	2,290	10,990
			175	0.6	~19	2,040	7,340	175	0.6	~19	2,040	9,790
Mold steel (HPM7, PX5, P20) 30-36 HRC	ENMU 100412 ZER-PH	JC8050 (JC7560)	~75	0.8	~19	2,040	7,340	~75	0.8	~19	2,040	9,790
			125	0.6	~19	2,040	7,340	125	0.6	~19	2,040	9,790
			175	0.6	~19	1,660	5,980	175	0.6	~19	1,660	7,970
Mold steel (NAK80, HPM1, P21) 38-43HRC	ENMU 100412 ZER-PH	JC8118 (JC8050)	~75	0.6	~19	1,210	3,990	~75	0.6	~19	1,210	5,320
			125	0.5	~19	1,080	2,920	125	0.5	~19	1,080	3,890
			175	0.5	~19	1,020	2,750	175	0.5	~19	1,020	3,670
Hardened die steel (SKD61, DAC, DHA) 42-52HRC	ENMU100412 ZER-PH (ENMU100412 ZER-SL)	JC8118 (JC7518)	~75	0.6	~19	1,210	3,990	~75	0.6	~19	1,210	5,320
			125	0.5	~19	1,080	2,920	125	0.5	~19	1,080	3,890
			175	0.5	~19	1,020	2,750	175	0.5	~19	1,020	3,670
Hardened die steel (SKD11, SLD, DC11) 55-62HRC	ENMQ100312 ZER (ENMU100312 ZER-HL)	DH102	~75	0.2	~19	1,020	920	~75	0.2	~19	1,020	1,220
			125	0.15	~19	890	670	125	0.15	~19	890	890
			175	0.1	~19	830	620	175	0.1	~19	830	830
Grey cast iron (FC250) 160-260HB	ENMU 100412 ZER-PH	JC8118 (JC8050)	~75	1	~19	2,550	11,480	~75	1	~19	2,550	15,300
			125	0.8	~19	2,550	11,480	125	0.8	~19	2,550	15,300
			175	0.6	~19	2,290	8,240	175	0.6	~19	2,290	10,990
Nodular cast iron (FCD700) 170-300HB	ENMU 100412 ZER-PH	JC8118 (JC8050)	~75	1	~19	2,550	11,480	~75	1	~19	2,550	15,300
			125	0.8	~19	2,550	11,480	125	0.8	~19	2,550	15,300
			175	0.6	~19	2,290	8,240	175	0.6	~19	2,290	10,990
Austenitic stainless steel (SUS304, 316, 317) 17Cr	ENMU 100412 ZER-SL	JC7550 (JC7518)	~75	0.6	~19	1,530	4,590	~75	0.6	~19	1,530	6,120
			125	0.5	~19	1,530	4,590	125	0.5	~19	1,530	6,120
			175	0.5	~19	1,270	3,050	175	0.5	~19	1,270	4,060
Precipitation hardening stainless steel (SUS630)	ENMU100412 ZER-SL ENMU100412 ZER-PH	JC7550 (JC8050)	~75	0.5	~19	1,270	2,670	~75	0.5	~19	1,270	3,560
			125	0.4	~19	1,270	2,670	125	0.4	~19	1,270	3,560
			175	0.4	~19	1,150	2,070	175	0.4	~19	1,150	2,760
Duplex stainless steel (S32750)	ENMU100412 ZER-SL ENMU100412 ZER-PH	JC7550 (JC8050)	~75	0.6	~19	1,270	1,140	~75	0.6	~19	1,270	1,520
			125	0.5	~19	1,270	1,140	125	0.5	~19	1,270	1,520
			175	0.5	~19	1,150	690	175	0.5	~19	1,150	920
Titanium alloy (Ti-6Al-4V) 35-43HRC	ENMU 100412 ZER-SL	DS150 (DS118)	~75	0.5	~19	760	1,600	~75	0.5	~19	760	2,130
			125	0.4	~19	760	1,600	125	0.4	~19	760	2,130
			175	0.4	~19	640	1,150	175	0.4	~19	640	1,540
Heat resistant alloy (INCO718) 35-43HRC	ENMU 100412 ZER-SL	DS118 (DS150)	~75	0.5	~19	380	340	~75	0.5	~19	380	460
			125	0.3	~19	380	340	125	0.3	~19	380	460
			175	0.2	~19	380	340	175	0.2	~19	380	460

Note

1. Please adjust cutting conditions according to machine rigidity or work rigidity.
2. In case of chatter occurring, recommended to reduce ap or rpm and keep feed per tooth.
3. ap should be reduced when using on low rigidity machine.
4. Use air blow.

QM MAX GII
GMX/MXG Type
■ Recommended cutting conditions
● Modular Head Type + MSN shank

Material	Cat.No.	Grade	Tool dia.(mm)									
			30/32/35					40/42				
			5N					6N				
			ϕ (mm)	a_p (mm)	a_e (mm)	n (min ⁻¹)	V_f (mm/min)	ϕ (mm)	a_p (mm)	a_e (mm)	n (min ⁻¹)	V_f (mm/min)
Carbon steel (S50C, S55C) below 250HB	ENMU 100412 ZER-PH	JC8050 (JC7560)	~90	0.8	~25	1,910	11,460	~120	0.8	~32	1,430	10,300
			150	0.6	~25	1,910	11,460	200	0.6	~32	1,430	10,300
			210	0.6	~25	1,700	10,200	280	0.6	~32	1,270	9,140
Tool & die steel (SKD61, SKD11) below 255HB	ENMU 100412 ZER-PH	JC8050 (JC7560)	~90	0.8	~25	1,910	11,460	~120	0.8	~32	1,430	10,300
			150	0.6	~25	1,910	11,460	200	0.6	~32	1,430	10,300
			210	0.6	~25	1,700	10,200	280	0.6	~32	1,270	9,140
Mold steel (HPM7, PX5, P20) 30-36 HRC	ENMU 100412 ZER-PH	JC8050 (JC7560)	~90	0.8	~25	1,700	10,200	~120	0.8	~32	1,270	9,140
			150	0.6	~25	1,700	10,200	200	0.6	~32	1,270	9,140
			210	0.6	~25	1,380	8,280	280	0.6	~32	1,030	7,420
Mold steel (NAK80, HPM1, P21) 38-43HRC	ENMU 100412 ZER-PH	JC8118 (JC8050)	~90	0.6	~25	1,010	5,560	~120	0.6	~32	760	5,020
			150	0.5	~25	900	4,050	200	0.5	~32	680	3,670
			210	0.5	~25	850	3,830	280	0.5	~32	640	3,460
Hardened die steel (SKD61, DAC, DHA) 42-52HRC	ENMU100412 ZER-PH (ENMU100412 ZER-SL)	JC8118 (JC7518)	~90	0.6	~25	1,010	5,560	~120	0.6	~32	760	5,020
			150	0.5	~25	900	4,050	200	0.5	~32	680	3,670
			210	0.5	~25	850	3,830	280	0.5	~32	640	3,460
Hardened die steel (SKD11, SLD, DC11) 55-62HRC	ENMQ100312 ZER (ENMU100312 ZER-HL)	DH102	~90	0.2	~25	850	1,280	~120	0.2	~32	640	1,150
			150	0.15	~25	740	930	200	0.15	~32	560	840
			210	0.1	~25	690	860	280	0.1	~32	520	780
Grey cast iron (FC250) 160-260HB	ENMU 100412 ZER-PH	JC8118 (JC8050)	~90	1	~25	2,120	15,900	~120	1	~32	1,590	14,310
			150	0.8	~25	2,120	15,900	200	0.8	~32	1,590	14,310
			210	0.6	~25	1,910	11,460	280	0.6	~32	1,430	10,300
Nodular cast iron (FCD700) 170-300HB	ENMU 100412 ZER-PH	JC8118 (JC8050)	~90	1	~25	2,120	15,900	~120	1	~32	1,590	14,310
			150	0.8	~25	2,120	15,900	200	0.8	~32	1,590	14,310
			210	0.6	~25	1,910	11,460	280	0.6	~32	1,430	10,300
Austenitic stainless steel (SUS304, 316, 317) 17Cr	ENMU 100412 ZER-SL	JC7550 (JC7518)	~90	0.6	~25	1,270	6,350	~120	0.6	~32	950	5,700
			150	0.5	~25	1,270	6,350	200	0.5	~32	950	5,700
			210	0.5	~25	1,060	4,240	280	0.5	~32	800	3,840
Precipitation hardening stainless steel (SUS630)	ENMU100412 ZER-SL ENMU100412 ZER-PH	JC7550 (JC8050)	~90	0.5	~25	1,060	3,710	~120	0.5	~32	800	3,360
			150	0.4	~25	1,060	3,710	200	0.4	~32	800	3,360
			210	0.4	~25	950	2,850	280	0.4	~32	720	2,590
Duplex stainless steel (S32750)	ENMU100412 ZER-SL ENMU100412 ZER-PH	JC7550 (JC8050)	~90	0.6	~25	1,060	1,590	~120	0.6	~32	800	1,440
			150	0.5	~25	1,060	1,590	200	0.5	~32	800	1,440
			210	0.5	~25	950	950	280	0.5	~32	720	860
Titanium alloy (Ti-6Al-4V) 35-43HRC	ENMU 100412 ZER-SL	DS150 (DS118)	~90	0.5	~25	640	2,240	~120	0.5	~32	480	2,020
			150	0.4	~25	640	2,240	200	0.4	~32	480	2,020
			210	0.4	~25	530	1,590	280	0.4	~32	400	1,440
Heat resistant alloy (INCO718) 35-43HRC	ENMU 100412 ZER-SL	DS118 (DS150)	~90	0.5	~25	320	480	~120	0.5	~32	240	430
			150	0.3	~25	320	480	200	0.3	~32	240	430
			210	0.2	~25	320	480	280	0.2	~32	240	430

Note

1. Please adjust cutting conditions according to machine rigidity or work rigidity.
2. In case of chatter occurring, recommended to reduce a_p or rpm and keep feed per tooth.
3. a_p should be reduced when using on low rigidity machine.
4. Use air blow.

QM MAX GII**GMX/MXG Type**

■ Recommended cutting conditions

● Endmill Type

Material	Cat.No.	Grade	Tool dia.(mm)									
			16					20				
			2N					3N				
			ϕ (mm)	a_p (mm)	a_e (mm)	n (min ⁻¹)	V_f (mm/min)	ϕ (mm)	a_p (mm)	a_e (mm)	n (min ⁻¹)	V_f (mm/min)
Carbon steel (S50C, S55C) below 250HB	ENMU 100412 ZER-PH	JC8050 (JC7560)	~30	0.7	~10	3,580	8,590					
			30~50	0.6	~10	3,580	8,590	~60	0.6	~14	2,860	10,300
			50~70	0.6	~10	3,180	7,630	60~100	0.6	~14	2,550	9,180
Tool & die steel (SKD61, SKD11) below 255HB	ENMU 100412 ZER-PH	JC8050 (JC7560)	~30	0.7	~10	3,580	8,590					
			30~50	0.6	~10	3,580	8,590	~60	0.6	~14	2,860	10,300
			50~70	0.6	~10	3,180	7,630	60~100	0.6	~14	2,550	9,180
Mold steel (HPM7, PX5, P20) 30-36 HRC	ENMU 100412 ZER-PH	JC8050 (JC7560)	~30	0.7	~10	3,180	7,630					
			30~50	0.6	~10	3,180	7,630	~60	0.6	~14	2,550	9,180
			50~70	0.6	~10	2,590	6,220	60~100	0.6	~14	2,070	7,450
Mold steel (NAK80, HPM1, P21) 38-43HRC	ENMU 100412 ZER-PH	JC8118 (JC8050)	~30	0.6	~10	1,890	4,160					
			30~50	0.5	~10	1,690	3,040	~60	0.5	~14	1,350	3,650
			50~70	0.5	~10	1,590	2,860	60~100	0.5	~14	1,270	3,430
Hardened die steel (SKD61, DAC, DHA) 42-52HRC	ENMU100412 ZER-PH (ENMU100412 ZER-SL)	JC8118 (JC7518)	~30	0.6	~10	1,890	4,160					
			30~50	0.5	~10	1,690	3,040	~60	0.5	~14	1,350	3,650
			50~70	0.5	~10	1,590	2,860	60~100	0.5	~14	1,270	3,430
Hardened die steel (SKD11, SLD, DC11) 55-62HRC	ENMU100312 ZER (ENMU100312 ZER-HL)	DH102	~30	0.2	~10	1,590	950					
			30~50	0.15	~10	1,390	700	~60	0.15	~14	1,110	830
			50~70	0.1	~10	1,290	650	60~100	0.1	~14	1,030	770
Grey cast iron (FC250) 160-260HB	ENMU 100412 ZER-PH	JC8118 (JC8050)	~30	0.7	~10	3,980	11,940					
			30~50	0.7	~10	3,980	11,940	~60	0.8	~14	3,180	14,310
			50~70	0.6	~10	3,580	8,590	60~100	0.6	~14	2,860	10,300
Nodular cast iron (FCD700) 170-300HB	ENMU 100412 ZER-PH	JC8118 (JC8050)	~30	0.7	~10	3,980	11,940					
			30~50	0.7	~10	3,980	11,940	~60	0.8	~14	3,180	14,310
			50~70	0.6	~10	3,580	8,590	60~100	0.6	~14	2,860	10,300
Austenitic stainless steel (SUS304, 316, 317) 17Cr	ENMU 100412 ZER-SL	JC7550 (JC7518)	~30	0.6	~10	2,390	4,780					
			30~50	0.5	~10	2,390	4,780	~60	0.5	~14	1,910	5,730
			50~70	0.5	~10	1,990	3,180	60~100	0.5	~14	1,590	3,820
Precipitation hardening stainless steel (SUS630)	ENMU100412 ZER-SL ENMU100412 ZER-PH	JC7550 (JC8050)	~30	0.5	~10	1,990	2,790					
			30~50	0.4	~10	1,990	2,790	~60	0.4	~14	1,590	3,340
			50~70	0.4	~10	1,790	2,150	60~100	0.4	~14	1,430	2,570
Duplex stainless steel (S32750)	ENMU100412 ZER-SL ENMU100412 ZER-PH	JC7550 (JC8050)	~30	0.6	~10	1,990	1,190					
			30~50	0.5	~10	1,990	1,190	~60	0.5	~14	1,590	1,430
			50~70	0.5	~10	1,790	720	60~100	0.5	~14	1,430	860
Titanium alloy (Ti-6Al-4V) 35-43HRC	ENMU 100412 ZER-SL	DS150 (DS118)	~30	0.5	~10	1,190	1,670					
			30~50	0.4	~10	1,190	1,670	~60	0.4	~14	950	2,000
			50~70	0.4	~10	990	1,190	60~100	0.4	~14	800	1,440
Heat resistant alloy (INCO718) 35-43HRC	ENMU 100412 ZER-SL	DS118 (DS150)	~30	0.5	~10	600	360					
			30~50	0.3	~10	600	360	~60	0.3	~14	480	430
			50~70	0.2	~10	600	360	60~100	0.2	~14	480	430

Note

1. Please adjust cutting conditions according to machine rigidity or work rigidity.
2. In case of chatter occurring, recommended to reduce a_p or rpm and keep feed per tooth.
3. a_p should be reduced when using on low rigidity machine.
4. Use air blow.

QM MAX GII**GMX/MXG Type**

■ Recommended cutting conditions

● Endmill Type

Material	Cat.No.	Grade	Tool dia.(mm)									
			25					32				
			4N					5N				
			ℓ (mm)	a_p (mm)	a_e (mm)	n (min ⁻¹)	V_f (mm/min)	ℓ (mm)	a_p (mm)	a_e (mm)	n (min ⁻¹)	V_f (mm/min)
Carbon steel (S50C, S55C) below 250HB	ENMU 100412 ZER-PH	JC8050 (JC7560)	~70	0.6	~19	2,290	10,990	~90	0.6	~25	1,790	10,740
			70~120	0.6	~19	2,040	9,790	90~140	0.6	~25	1,590	9,540
Tool & die steel (SKD61, SKD11) below 255HB	ENMU 100412 ZER-PH	JC8050 (JC7560)	~70	0.6	~19	2,290	10,990	~90	0.6	~25	1,790	10,740
			70~120	0.6	~19	2,040	9,790	90~140	0.6	~25	1,590	9,540
Mold steel (HPM7, PX5, P20) 30-36 HRC	ENMU 100412 ZER-PH	JC8050 (JC7560)	~70	0.6	~19	2,040	9,790	~90	0.6	~25	1,590	9,540
			70~120	0.6	~19	1,660	7,970	90~140	0.6	~25	1,290	7,740
Mold steel (NAK80, HPM1, P21) 38-43HRC	ENMU 100412 ZER-PH	JC8118 (JC8050)	~70	0.5	~19	1,080	3,890	~90	0.5	~25	850	3,830
			70~120	0.5	~19	1,020	3,670	90~140	0.5	~25	800	3,600
Hardened die steel (SKD61, DAC, DHA) 42-52HRC	ENMU100412 ZER-PH (ENMU100412 ZER-SL)	JC8118 (JC7518)	~70	0.5	~19	1,080	3,890	~90	0.5	~25	850	3,830
			70~120	0.5	~19	1,020	3,670	90~140	0.5	~25	800	3,600
Hardened die steel (SKD11, SLD, DC11) 55-62HRC	ENMQ100312 ZER (ENMU100312 ZER-HL)	DH102	~70	0.15	~19	890	890	~90	0.15	~25	700	880
			70~120	0.1	~19	830	830	90~140	0.1	~25	650	810
Grey cast iron (FC250) 160-260HB	ENMU 100412 ZER-PH	JC8118 (JC8050)	~70	0.8	~19	2,550	15,300	~90	0.8	~25	1,990	14,930
			70~120	0.6	~19	2,290	10,990	90~140	0.6	~25	1,790	10,740
Nodular cast iron (FCD700) 170-300HB	ENMU 100412 ZER-PH	JC8118 (JC8050)	~70	0.8	~19	2,550	15,300	~90	0.8	~25	1,990	14,930
			70~120	0.6	~19	2,290	10,990	90~140	0.6	~25	1,790	10,740
Austenitic stainless steel (SUS304, 316, 317) 17Cr	ENMU 100412 ZER-SL	JC7550 (JC7518)	~70	0.5	~19	1,530	6,120	~90	0.5	~25	1,190	5,950
			70~120	0.5	~19	1,270	4,060	90~140	0.5	~25	990	3,960
Precipitation hardening stainless steel (SUS630)	ENMU100412 ZER-SL ENMU100412 ZER-PH	JC7550 (JC8050)	~70	0.4	~19	1,270	3,560	~90	0.4	~25	990	3,470
			70~120	0.4	~19	1,150	2,760	90~140	0.4	~25	900	2,700
Duplex stainless steel (S32750)	ENMU100412 ZER-SL ENMU100412 ZER-PH	JC7550 (JC8050)	~70	0.5	~19	1,270	1,520	~90	0.5	~25	990	1,490
			70~120	0.5	~19	1,150	920	90~140	0.5	~25	900	900
Titanium alloy (Ti-6Al-4V) 35-43HRC	ENMU 100412 ZER-SL	DS150 (DS118)	~70	0.4	~19	760	2,130	~90	0.4	~25	600	2,100
			70~120	0.4	~19	640	1,540	90~140	0.4	~25	500	1,500
Heat resistant alloy (INCO718) 35-43HRC	ENMU 100412 ZER-SL	DS118 (DS150)	~70	0.3	~19	380	460	~90	0.3	~25	300	450
			70~120	0.2	~19	380	460	90~140	0.2	~25	300	450

Note

1. Please adjust cutting conditions according to machine rigidity or work rigidity.
2. In case of chatter occurring, recommended to reduce a_p or rpm and keep feed per tooth.
3. a_p should be reduced when using on low rigidity machine.
4. Use air blow.

QM MAX GII**GMX/MXG Type**

■ Recommended cutting conditions

● Facemill Type

Material	Cat.No.	Grade	Tool dia.(mm)									
			50/52					63/66				
			7N					7N				
			ℓ (mm)	a _p (mm)	a _e (mm)	n (min ⁻¹)	V _f (mm/min)	ℓ (mm)	a _p (mm)	a _e (mm)	n (min ⁻¹)	V _f (mm/min)
Carbon steel (S50C, S55C) below 250HB	ENMU 100412 ZER-PH	JC8050 (JC7560)	~150	1	~40	1,020	8,570	~150	1	~50	810	6,800
			200	0.8	~40	1,020	8,570	200	0.8	~50	810	6,800
			250	0.6	~40	890	7,480	250	0.6	~50	710	5,960
			300	0.5	~40	830	6,970	300	0.5	~50	660	5,540
			350	0.4	~40	830	6,970	350	0.4	~50	660	5,540
Tool & die steel (SKD61, SKD11) below 255HB	ENMU 100412 ZER-PH	JC8050 (JC7560)	~150	1	~40	1,020	8,570	~150	1	~50	810	6,800
			200	0.8	~40	1,020	8,570	200	0.8	~50	810	6,800
			250	0.6	~40	890	7,480	250	0.6	~50	710	5,960
			300	0.5	~40	830	6,970	300	0.5	~50	660	5,540
			350	0.4	~40	830	6,970	350	0.4	~50	660	5,540
Mold steel (HPM7, PX5, P20) 30-36 HRC	ENMU 100412 ZER-PH	JC8050 (JC7560)	~150	1	~40	1,020	8,570	~150	1	~50	810	6,800
			200	0.8	~40	1,020	8,570	200	0.8	~50	810	6,800
			250	0.6	~40	890	7,480	250	0.6	~50	710	5,960
			300	0.5	~40	830	6,970	300	0.5	~50	660	5,540
			350	0.4	~40	830	6,970	350	0.4	~50	660	5,540
Mold steel (NAK80, HPM1, P21) 38-43HRC	ENMU 100412 ZER-PH	JC8118 (JC8050)	~150	0.8	~40	540	4,160	~150	0.8	~50	430	3,310
			200	0.6	~40	540	4,160	200	0.6	~50	430	3,310
			250	0.4	~40	510	3,210	250	0.4	~50	400	2,520
			300	0.3	~40	480	3,020	300	0.3	~50	380	2,390
			350	0.3	~40	480	2,690	350	0.3	~50	380	2,130
Hardened die steel (SKD61, DAC, DHA) 42-52HRC	ENMU100412 ZER-PH (ENMU100412 ZER-SL)	JC8118 (JC7518)	~150	0.6	~40	540	4,160	~150	0.6	~50	430	3,310
			200	0.4	~40	540	4,160	200	0.4	~50	430	3,310
			250	0.2	~40	510	3,210	250	0.2	~50	400	2,520
			300	0.1	~40	510	3,210	300	0.1	~50	400	2,520
			350	—	—	—	—	350	—	—	—	—
Hardened die steel (SKD11, SLD, DC11) 55-62HRC	ENMQ100312 ZER (ENMU100312 ZER-HL)	DH102	~150	0.2	~40	510	1,070	~150	0.2	~50	400	840
			200	0.15	~40	450	790	200	0.15	~50	350	610
			250	0.1	~40	410	720	250	0.1	~50	330	580
			300	—	—	—	—	300	—	—	—	—
			350	—	—	—	—	350	—	—	—	—
Grey cast iron (FC250) 160-260HB	ENMU 100412 ZER-PH	JC8118 (JC8050)	~150	1	~40	1,150	12,080	~150	1	~50	910	9,560
			200	0.8	~40	1,150	12,080	200	0.8	~50	910	9,560
			250	0.6	~40	1,020	10,710	250	0.6	~50	810	8,510
			300	0.5	~40	950	9,980	300	0.5	~50	760	7,980
			350	0.4	~40	950	7,980	350	0.4	~50	760	6,380
Nodular cast iron (FCD700) 170-300HB	ENMU 100412 ZER-PH	JC8118 (JC8050)	~150	1	~40	1,150	12,080	~150	1	~50	910	9,560
			200	0.8	~40	1,150	12,080	200	0.8	~50	910	9,560
			250	0.6	~40	1,020	10,710	250	0.6	~50	810	8,510
			300	0.5	~40	950	9,980	300	0.5	~50	760	7,980
			350	0.4	~40	950	7,980	350	0.4	~50	760	6,380

Note

1. Please adjust cutting conditions according to machine rigidity or work rigidity.
2. In case of chatter occurring, recommended to reduce a_p or rpm and keep feed per tooth.
3. a_p should be reduced when using on low rigidity machine.
4. Use air blow.

QM MAX GII
GMX/MXG Type
■ Recommended cutting conditions
● Facemill Type

Material	Cat.No.	Grade	Tool dia.(mm)									
			50/52					63/66				
			7N					7N				
			ϕ (mm)	a_p (mm)	a_e (mm)	n (min ⁻¹)	V_f (mm/min)	ϕ (mm)	a_p (mm)	a_e (mm)	n (min ⁻¹)	V_f (mm/min)
Austenitic stainless steel (SUS304, 316, 317) 17Cr	ENMU 100412 ZER-SL	JC8050 (JC7518)	~150	0.8	~40	760	5,320	~150	0.8	~50	610	4,270
			200	0.6	~40	760	5,320	200	0.6	~50	610	4,270
			250	0.4	~40	640	4,480	250	0.4	~50	510	3,570
			300	0.3	~40	640	4,480	300	0.3	~50	510	3,570
			350	0.3	~40	640	3,580	350	0.3	~50	510	2,860
Precipitation hardening stainless steel (SUS630)	ENMU100412 ZER-SL ENMU100412 ZER-PH	JC7550 (JC8050)	~150	0.6	~40	640	3,140	~150	0.6	~50	510	2,500
			200	0.5	~40	640	3,140	200	0.5	~50	510	2,500
			250	0.3	~40	570	2,790	250	0.3	~50	450	2,210
			300	0.2	~40	570	2,790	300	0.2	~50	450	2,210
			350	0.2	~40	570	2,390	350	0.2	~50	450	1,890
Duplex stainless steel (S32750)	ENMU100412 ZER-SL ENMU100412 ZER-PH	JC7550 (JC8050)	~150	0.8	~40	640	1,340	~150	0.8	~50	510	1,070
			200	0.6	~40	640	1,340	200	0.6	~50	510	1,070
			250	0.4	~40	570	1,200	250	0.4	~50	450	950
			300	0.3	~40	570	1,200	300	0.3	~50	450	950
			350	0.3	~40	570	800	350	0.3	~50	450	630
Titanium alloy (Ti-6Al-4V) 35-43HRC	ENMU 100412 ZER-SL	DS150 (DS118)	~150	0.7	~40	380	1,860	~150	0.7	~50	300	1,470
			200	0.5	~40	380	1,860	200	0.5	~50	300	1,470
			250	0.3	~40	320	1,570	250	0.3	~50	250	1,230
			300	0.3	~40	320	1,570	300	0.3	~50	250	1,230
			350	0.3	~40	320	1,340	350	0.3	~50	250	1,050
Heat resistant alloy (INCO718) 35-43HRC	ENMU 100412 ZER-SL	DS118 (DS150)	~150	0.7	~40	190	400	~150	0.7	~50	150	320
			200	0.5	~40	190	400	200	0.5	~50	150	320
			250	0.3	~40	160	340	250	0.3	~50	130	270
			300	0.2	~40	160	340	300	0.2	~50	130	270
			350	0.2	~40	130	270	350	0.2	~50	100	210

Note

1. Please adjust cutting conditions according to machine rigidity or work rigidity.
2. In case of chatter occurring, recommended to reduce a_p or rpm and keep feed per tooth.
3. a_p should be reduced when using on low rigidity machine.
4. Use air blow.

QM MAX**MQX/QXP Type**

QM *Quick & Mini* **MAX**

New generation high feed mill "QM MAX"

Modular Head
φ16~φ42

Facemill
φ40~φ66

G-Body

Endmill
φ16~φ40



Low cutting force geometry

Unique 3D geometry insert provides stable cutting and less power consumption.

Multi - flutes specification

High speed and high efficient machining.

Vibration free

Control vibration with combination of MSN carbide shank holder

QM MAX **MQX/QXP Type**

Insert Line-Up

High feed insert



EPMT100312ZER EPMT100312ZER

High feed insert for unfavorable conditions



EPMW100312ZER EPMW100312ZTR EPMW100312ZTR

For high hardened steel



EPHW100316ZTR

Shoulder insert for aluminum



ZPMT1003...ZER-NL
(R0.4, 0.8, 2.0)

Shoulder insert for general steel



ZPMT1003...ZER-PL
(R0.4, 0.8, 2.0)

Shoulder insert for Ti alloy



ZPMT1003...ZER-SL
(R0.4, 0.8, 2.0)

"Mirror Insert" for finishing side & bottom face



YPHW1003...ZER-... **CBN insert**
YPHW100308ZTR-F1

A variety of inserts all fit into the same body.
Multi-purpose cutter that can high feed, square up and finish.

QM MAX **MQX/QXP Type**

■ **Facemill Type**



Through coolant hole



● **Highfeed**

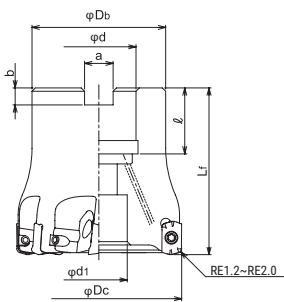

● **Shoulder milling**

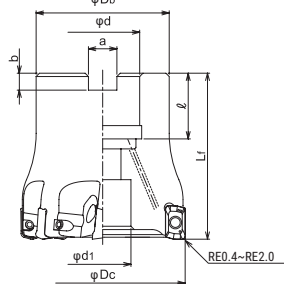

● **High feed (QXP-8066R)**

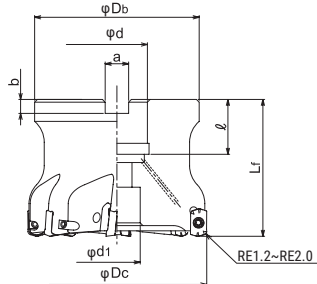

● **Shoulder milling (QXP-8066R)**

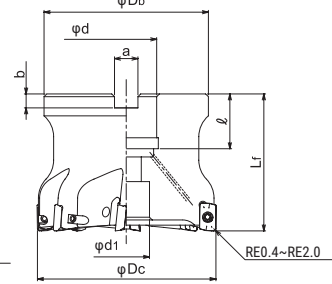

Cat.No	Stock	No. of inserts	Dimensions (mm)								Inserts
			φDc	Lf	φDb	φd	φd1	a	b	ℓ	
QXP-6040R-16	●	6	40	45	35	16	14	8.4	5.6	18	EP**1003**Z*R; ZPMT1003**ZER**; YPHW1003**Z*R**
QXP-7040R-16	●	7									
QXP-7050R-22	●	8	50	50	40	22	17	10.4	6.3	20	
QXP-8050R-22	●										
QXP-8052R-22	●										
QXP-8063R-22	●				48	27	20	12.4	7	22	
QXP-8066R-27	●										

Screw	Torque(N.m)	Wrench
DSW-2563H	1.1	A-08

QM MAX **MQX/QXP Type**

■ Endmill Shank Type

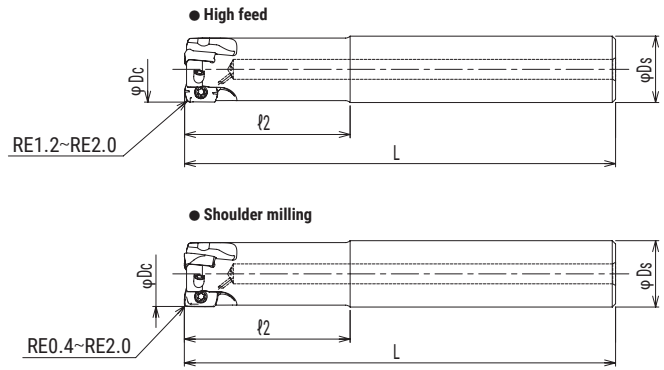
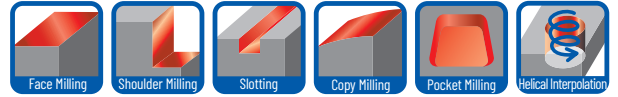

Cat.No	Stock	No. of inserts	Dimensions (mm)					Parts		Inserts
			φDc	ℓ2	L	φD1	φDs	Screws	Wrench	
QXPS2016S16+A	●	2	16	30	100	15	16	TSW-2556H	A-08	EP**1003**Z*R; ZPMT1003**ZER-**; YPHW1003**Z*R-**
QXPS3020S20+A	●	3	20	50	130	18.85	20			
QXPS4025S25+A	●	4	25	60	140	23.6	25	DSW-2563H		

Screw	Torque(N.m)
TSW-2556H	1.1
DSW-2563H	

QM MAX **MQX/QXP Type**

■ **Modular Head Type**

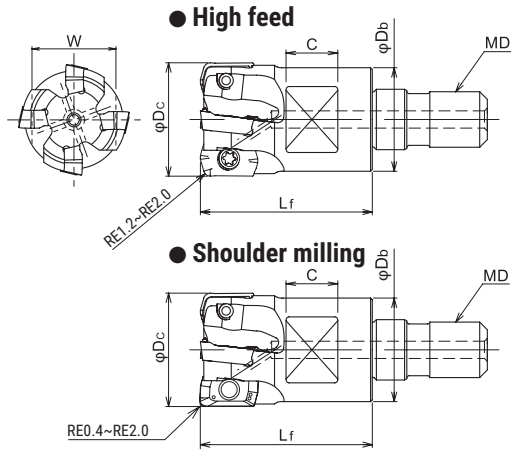
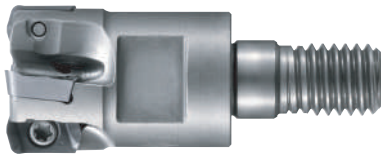
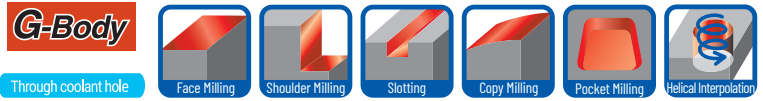

Cat.No	Stock	No. of inserts	Dimensions (mm)						Parts		Inserts
			φDc	Lf	φDb	MD	C	W	Screws	Wrench	
MQX-2016-M8	●	2	16	23	14	M8	8	12	TSW-2556H	A-08	EP**1003**Z*R; ZPMT1003**ZER-**; YPHW1003**Z*R-**
MQX-2017-M8	●		17			M8					
MQX-3020-M10	●	3	20	30	18	M10	9	14			
MQX-4020-M10	●					M10					
MQX-4021-M10	●	4	21	35	22.5	M12	10	17			
MQX-4025-M12	●					M12					
MQX-5025-M12	●	5	25	43	23.6	M12	12	22			
MQX-4026-M12	●					M12					
MQX-5026-M12	●	4	26	43	27	M16	14	26			
MQX-5028-M12	●					M16					
MQX-5030-M16	●	5	30	43	29	M16	14	26			
MQX-5032-M16	●					M16					
MQX-6032-M16	●	6	32	43	29	M16	14	26			
MQX-5035-M16	●					M16					
MQX-6035-M16	●	5	35	43	32	M16	14	26			
MQX-6040-M16	●					M16					
MQX-6040-M16	●	6	40	43	32	M16	14	26			
MQX-7040-M16	●					M16					
MQX-6042-M16	●	7	42	43	32	M16	14	26			
MQX-6042-M16	●					M16					

Screw	Torque(N.m)
TSW-2556H	1.1
DSW-2563H	

QM MAX **MQX/QXP Type**

Insert

High feed insert
(EPMT1003 * * ZER)

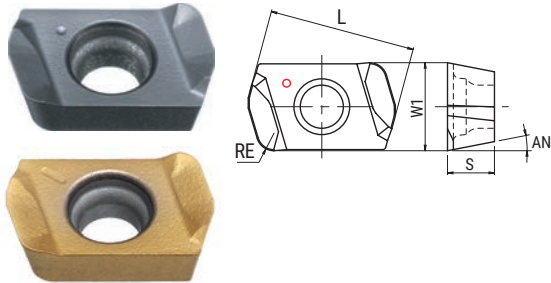

Shoulder insert for general steel
(ZPMT1003 * * ZER-PL)

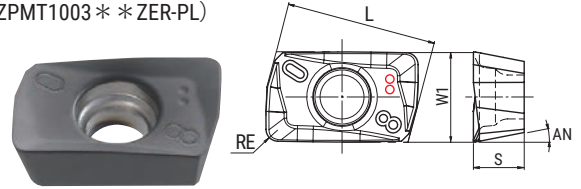

Shoulder insert for Ti alloy
(ZPMT1003 * * ZER-SL)

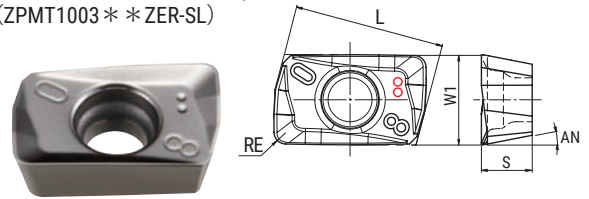

High feed insert for unfavorable conditions
(EPMW100312ZER)

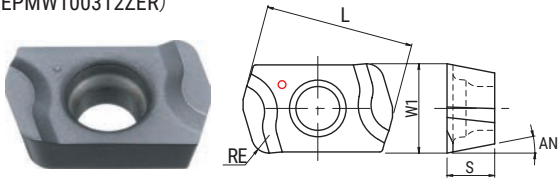

"Mirror Insert" for finishing side & bottom face
(YPHW1003 * * ZER-15) (YPHW100308ZTR-F1) (YPHW100308ZER-F)

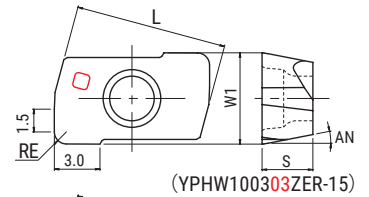

High feed insert for unfavorable conditions
(EPMW100312ZTR)

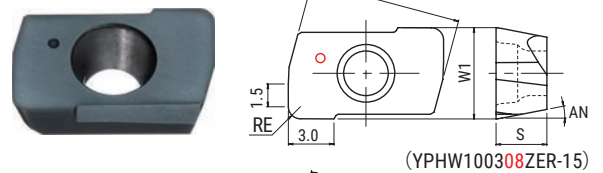
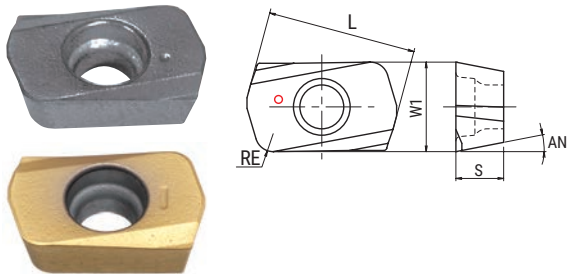

For high hardened steel
(EPHW100316ZTR)

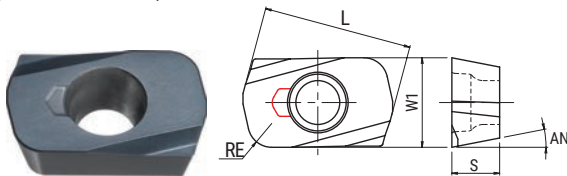

CBN insert

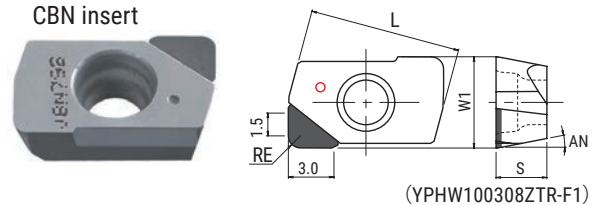

Shoulder insert for aluminum
(ZPMT1003 * * ZER-NL)

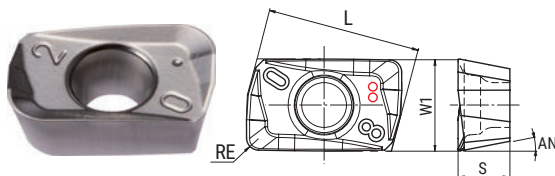

"Mirror Insert" for finishing side & bottom face
(YPHW100320ZER-24)

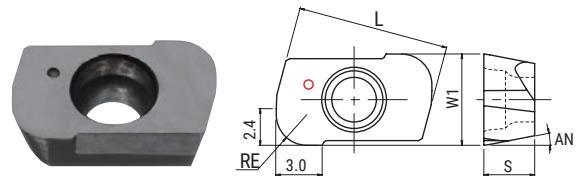

QM MAX **MQX/QXP Type**

■ **Insert**

Type	Cat.No.	Tolerance	PVD coating								Uncoated	Cermet	CBN	Dimensions (mm)				
			JC8118	DH102	JC7518	JC7560	JC8015	JC8050	DS118	DS150				FC18	CX75	JBN795	L	S
High feed insert	EPMT100312ZER	M	●			●		●	●	●				10	3.2	6	1.2	11°
	EPMT100320ZER	M	●											10	3.2	6	2.0	11°
High feed insert for unfavorable conditions	EPMW100312ZER	M	●					●						10	3.2	6	1.2	11°
	EPMW100312ZTR	M	●			●		●						10	3.2	6	1.2	11°
For high hardened steel	EPHW100316ZTR	H	●	●										10	3.2	6	1.6	11°
Shoulder insert for aluminum	ZPMT100304ZER-NL	M									●			10.08	3.4	6	0.4	11°
	ZPMT100308ZER-NL	M									●			10.08	3.4	6	0.8	11°
	ZPMT100320ZER-NL	M									●			10.08	3.4	6	2.0	11°
Shoulder insert for general steel	ZPMT100304ZER-PL	M	●	●				●				●		10.08	3.4	6	0.4	11°
	ZPMT100308ZER-PL	M	●	●				●				●		10.08	3.4	6	0.8	11°
	ZPMT100320ZER-PL	M	●	●				●				●		10.08	3.4	6	2.0	11°
Shoulder insert for Ti alloy	ZPMT100304ZER-SL	M			●				●					10.08	3.4	6	0.4	11°
	ZPMT100308ZER-SL	M			●				●					10.08	3.4	6	0.8	11°
	ZPMT100320ZER-SL	M			●				●					10.08	3.4	6	2.0	11°
"Mirror Insert" for finishing side & bottom face	YPHW100303ZER-15	H		●			●					●		10.06	3.35	6	0.3	11°
	YPHW100308ZER-15	H		●								●		10.06	3.35	6	0.8	11°
	YPHW100308ZER-F	H					●							10.06	3.35	6	0.8	11°
	YPHW100308ZTR-F1	H										●		10.06	3.35	6	0.8	11°
	YPHW100320ZER-24	H		●			●							10.06	3.35	6	2.0	11°

GRADE MARKING



JC8118 / DS118

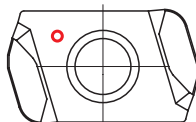

JC8050 / JC7560 / DS150

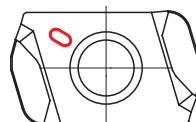

QM MAX

MQX/QXP Type

■ Insert selection guide

Material	Carbon steel (S50C, S55C) below 250HB						Tool & die steel (SKD61, SKD11) below 255HB						Mold steel (HPM7, PX5, P20) 30-36HRC						Mold steel (NAK80, HPM1, P21) 38-43HRC					
	Cat.No.	Grade					Cat.No.	Grade					Cat.No.	Grade					Cat.No.	Grade				
EPMT1003**ZER	☆	☆	☆				☆	☆	☆				☆	☆	☆				☆	☆				
EPMW100312ZER																			○					
EPMW100312ZTR	○	○	◎				○	○	◎				○	○	◎				◎	○				
EPHW100316ZTR																								

Material	Hardened die steel (SKD61, DAC, DHA) 42-52 HRC						Hardened die steel (SKD11, SLD, DC11) 55-62HRC						Grey cast iron (FC, FCD) below 300HB						Stainless steel (SUS304) below 250HB					
	Cat.No.	Grade					Cat.No.	Grade					Cat.No.	Grade					Cat.No.	Grade				
EPMT1003**ZER	☆						×	×					○						◎	○				
EPMW100312ZER	○						○						◎						●					
EPMW100312ZTR	●						●						●	○										
EPHW100316ZTR	◎									◎														

Material	Titanium alloy (Ti-6Al-4V)						Heat resistant alloy (INCO718)					
	Cat.No.	Grade					Cat.No.	Grade				
EPMT1003**ZER	○	○	●		○	◎	◎	○	○		○	○
EPMW100312ZER		●						●				
EPMW100312ZTR												
EPHW100316ZTR												

- EPMT Type : with chip breaker
- EPMW Type : without chip breaker
- EPMW Type : without chip breaker

- ◎ : First choice
- : For general milling
- : For unstable milling
- ☆ : For light cutting force
- × : Not recommended

■ Definition of corner shape for programming

• EPMT/W Type (RE=R1.2)

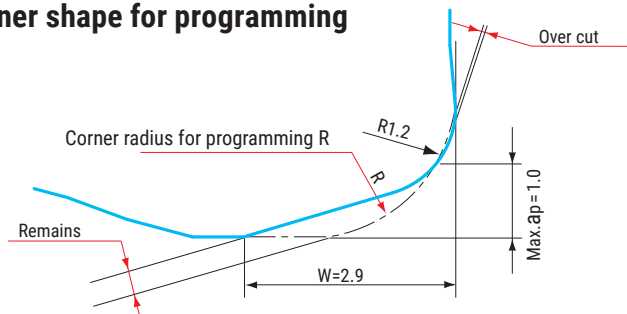

Corner radius for programming R	Over cut	Remains
R1.0	0	0.57
R1.5 (Std.)	0	0.45
R2.0	0.04	0.33
R2.5	0.21	0.21
R3.0	0.40	0.09

• EPMT Type (RE=R2.0)

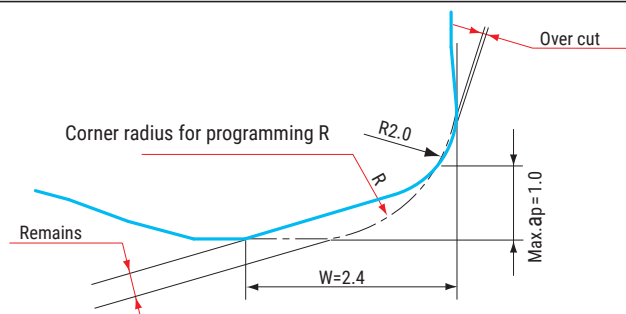

Corner radius for programming R	Over cut	Remains
R1.0	0	0.51
R1.5	0	0.31
R2.0 (Std.)	0	0.13
R2.5	0.12	0.04
R3.0	0.32	0

• EPHW Type

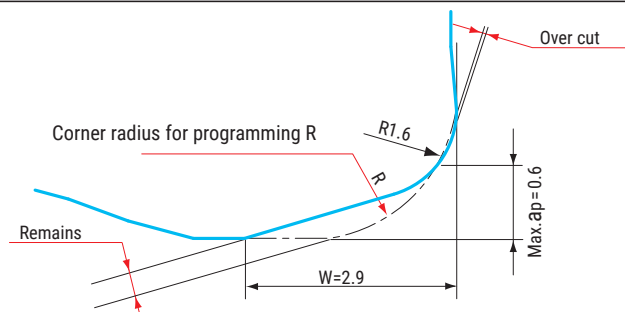

Corner radius for programming R	Over cut	Remains
R1.0	0	0.42
R1.5 (Std.)	0	0.33
R2.0	0.01	0.23
R2.5	0.17	0.14
R3.0	0.37	0.05

QM MAX **MQX/QXP Type**

■ **Recommended Data for Profile Milling**

Ramping

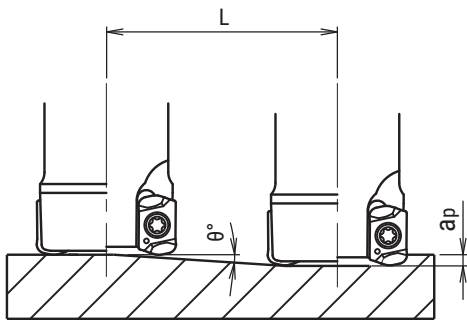

Helical interpolation

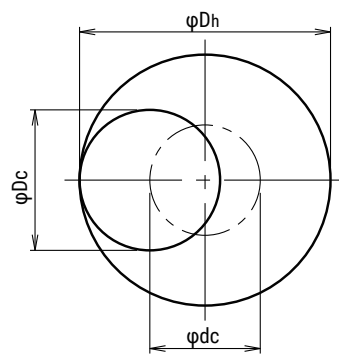

- Calculation of tool pass dia.

$$\varphi_{dc} = \varphi_{Dh} - \varphi_{Dc}$$

Tool pass dia. Bore dia. Tool Dia.

- Depth of cut per one circuit should not exceed max. depth of cut Ap
- Down cutting is recommended, tool pass rotation should be counterclockwise

- In case of ramping and helical interpolation, apply 70% or less feed (Vf) from standard cutting condition table
- In case of drilling, apply 50% or less Z axis feed (F) from standard cutting condition table
- Long consecutive chips may result in case of drilling, confirm safe operating conditions

■ **EPM*100312ZER**

Cat.No.	Tool dia.	Effective Cutting dia.	Max.depth of cut : ap	Ramping		Helical interpolation		Max.drilling depth Z(mm)
				Max.ramping angle θ	Max.depth of cut (ap) Total cutting length L (mm)	Min.Bore dia.	Max.Bore dia.	
QXP-*040R-16	40	34.1	1	0.5	114.6	70	78	0.6
QXP-*050R-**	50	44.1	1	0.4	143.2	90	98	0.6
QXP-8052R-22	52	46.1	1	0.35	163.7	94	102	0.6
QXP-8063R-**	63	57.1	1	0.3	191	116	124	0.6
QXP-8066R-**	66	60.1	1	0.3	191	122	130	0.6
QXP-2016-30-S16	16	10.2	0.8	1.8	25.5	22	30	0.6
QXP-3020-50-S20	20	14.1	0.8	1.4	32.7	30	38	0.6
QXP-4025-60-S25	25	19.1	0.8	1	45.8	40	48	0.6
QXP-5032-70-S32	32	26.1	0.8	0.7	65.5	54	62	0.5
QXP-6040-45-S32	40	34.1	0.8	0.5	91.7	70	78	0.6
MQX-*016-M8	16	10.2	0.8	1.8	25.5	22	30	0.6
MQX-*017-M8	17	11.2	0.8	1.6	28.6	24	32	0.6
MQX-*020-M10	20	14.1	0.8	1.4	32.7	30	38	0.6
MQX-*021-M10	21	15.1	0.8	1.3	35.3	32	40	0.6
MQX-*025-M12	25	19.1	0.8	1	45.8	40	48	0.6
MQX-*026-M12	26	20.1	0.8	0.95	48.2	42	50	0.6
MQX-*028-M12	28	22.1	0.8	0.85	53.9	46	54	0.6
MQX-*030-M16	30	24.1	0.8	0.8	57.3	50	58	0.5
MQX-*032-M16	32	26.1	0.8	0.7	65.5	54	62	0.5
MQX-*035-M16	35	29.1	0.8	0.6	76.4	60	68	0.5
MQX-*040-M16	40	34.1	0.8	0.5	91.7	70	78	0.6
MQX-*042-M16	42	36.2	0.8	0.45	101.9	74	82	0.6

QM MAX

MQX/QXP Type

■ Recommended Data for Profile Milling

■ **EPMT100320ZER**

Cat.No.	Tool dia.	Effective Cutting dia.	Max.depth of cut : ap	Ramping		Helical interpolation		Max.drilling depth Z(mm)
				Max.ramping angle θ	Max.depth of cut (ap) Total cutting length L (mm)	Min.Bore dia.	Max.Bore dia.	
QXP- *040R-16	40	35.1	1	0.55	104.2	72	78	0.7
QXP- *050R- * *	50	45.1	1	0.4	143.2	92	98	0.7
QXP-8052R-22	52	47.2	1	0.4	143.2	96	102	0.7
QXP-8063R- * *	63	58.2	1	0.3	191	118	124	0.7
QXP-8066R- * *	66	61.2	1	0.3	191	124	130	0.7
QXP-2016-30-S16	16	11.2	0.8	2.3	19.9	24	30	0.7
QXP-3020-50-S20	20	15.1	0.8	1.5	30.6	32	38	0.7
QXP-4025-60-S25	25	20.1	0.8	1.1	41.7	42	48	0.6
QXP-5032-70-S32	32	27.1	0.8	0.75	61.1	56	62	0.6
QXP-6040-45-S32	40	35.1	0.8	0.55	83.3	72	78	0.7
MQX- *016-M8	16	11.2	0.8	2.3	19.9	24	30	0.7
MQX- *017-M8	17	12.2	0.8	2	22.9	26	32	0.7
MQX- *020-M10	20	15.1	0.8	1.5	30.6	32	38	0.7
MQX- *021-M10	21	16.1	0.8	1.4	32.7	34	40	0.7
MQX- *025-M12	25	20.1	0.8	1.1	41.7	42	48	0.6
MQX- *026-M12	26	21.1	0.8	1	45.8	44	50	0.6
MQX- *028-M12	28	23.1	0.8	0.9	50.9	48	54	0.6
MQX- *030-M16	30	25.1	0.8	0.85	53.9	52	58	0.6
MQX- *032-M16	32	27.1	0.8	0.75	61.1	56	62	0.6
MQX- *035-M16	35	30.1	0.8	0.65	70.5	62	68	0.6
MQX- *040-M16	40	35.1	0.8	0.55	83.3	72	78	0.7
MQX- *042-M16	42	37.1	0.8	0.55	83.3	76	82	0.7

■ **EPMW100312ZTR**

Cat.No.	Tool dia.	Effective Cutting dia.	Max.depth of cut : ap	Ramping		Helical interpolation		Max.drilling depth Z(mm)
				Max.ramping angle θ	Max.depth of cut (ap) Total cutting length L (mm)	Min.Bore dia.	Max.Bore dia.	
QXP- *040R-16	40	34.1	1	0.4	143.2	70	78	0.6
QXP- *050R- * *	50	44.1	1	0.3	191	90	98	0.6
QXP-8052R-22	52	46.1	1	0.25	229.2	94	102	0.6
QXP-8063R- * *	63	57.1	1	0.2	286.5	116	124	0.6
QXP-8066R- * *	66	60.1	1	0.2	286.5	122	130	0.6
QXP-2016-30-S16	16	10.2	0.8	1.7	27	22	30	0.6
QXP-3020-50-S20	20	14.1	0.8	1.3	35.3	30	38	0.6
QXP-4025-60-S25	25	19.1	0.8	0.9	50.9	40	48	0.6
QXP-5032-70-S32	32	26.1	0.8	0.6	76.4	54	62	0.5
QXP-6040-45-S32	40	34.1	0.8	0.4	114.6	70	78	0.6
MQX- *016-M8	16	10.2	0.8	1.7	27	22	30	0.6
MQX- *017-M8	17	11.2	0.8	1.5	30.6	24	32	0.6
MQX- *020-M10	20	14.1	0.8	1.3	35.3	30	38	0.6
MQX- *021-M10	21	15.1	0.8	1.2	38.2	32	40	0.6
MQX- *025-M12	25	19.1	0.8	0.9	50.9	40	48	0.6
MQX- *026-M12	26	20.1	0.8	0.85	53.9	42	50	0.6
MQX- *028-M12	28	22.1	0.8	0.75	61.1	46	54	0.6
MQX- *030-M16	30	24.1	0.8	0.7	65.5	50	58	0.5
MQX- *032-M16	32	26.1	0.8	0.6	76.4	54	62	0.5
MQX- *035-M16	35	29.1	0.8	0.5	91.7	60	68	0.5
MQX- *040-M16	40	34.1	0.8	0.4	114.6	70	78	0.6
MQX- *042-M16	42	36.2	0.8	0.35	131	74	82	0.6

QM MAX**MQX/QXP Type****EPHW100316ZTR**

Cat.No.	Tool dia.	Effective Cutting dia.	Max.depth of cut : ap	Ramping		Helical interpolation		Max.drilling depth Z(mm)
				Max.ramping angle θ	Max.depth of cut (ap) Total cutting length L (mm)	Min.Bore dia.	Max.Bore dia.	
QXP-*040R-16	40	34.1	0.6	0.3	114.6	70	78	0.6
QXP-*050R-**	50	44.1	0.6	0.2	171.9	90	98	0.6
QXP-8052R-22	52	46.1	0.6	0.2	171.9	94	102	0.6
QXP-8063R-**	63	57.1	0.6	0.15	229.2	116	124	0.6
QXP-8066R-**	66	60.1	0.6	0.15	229.2	122	130	0.6
QXP-2016-30-S16	16	10.2	0.6	1.1	31.2	22	30	0.6
QXP-3020-50-S20	20	14.1	0.6	0.8	43	30	38	0.6
QXP-4025-60-S25	25	19.1	0.6	0.55	62.5	40	48	0.6
QXP-5032-70-S32	32	26.1	0.6	0.4	85.9	54	62	0.5
QXP-6040-45-S32	40	34.1	0.6	0.3	114.6	70	78	0.6
MQX-*016-M8	16	10.2	0.6	1.1	31.2	22	30	0.6
MQX-*017-M8	17	11.2	0.6	1	34.4	24	32	0.6
MQX-*020-M10	20	14.1	0.6	0.8	43	30	38	0.6
MQX-*021-M10	21	15.1	0.6	0.7	49.1	32	40	0.6
MQX-*025-M12	25	19.1	0.6	0.55	62.5	40	48	0.6
MQX-*026-M12	26	20.1	0.6	0.5	68.8	42	50	0.6
MQX-*028-M12	28	22.1	0.6	0.45	76.4	46	54	0.6
MQX-*030-M16	30	24.1	0.6	0.4	85.9	50	58	0.5
MQX-*032-M16	32	26.1	0.6	0.4	85.9	54	62	0.5
MQX-*035-M16	35	29.1	0.6	0.35	98.2	60	68	0.5
MQX-*040-M16	40	34.1	0.6	0.3	114.6	70	78	0.6
MQX-*042-M16	42	36.2	0.6	0.25	137.5	74	82	0.6

ZPMT100304ZER-**

Cat.No.	Tool dia.	Effective Cutting dia.	Max.depth of cut : ap	Ramping		Helical interpolation		Max.drilling depth Z(mm)
				Max.ramping angle θ	Max.depth of cut (ap) Total cutting length L (mm)	Min.Bore dia.	Max.Bore dia.	
QXP-*040R-16	40	39	1	0.95	60.3	75.6	78.4	0.6
QXP-*050R-**	50	49	1	0.7	81.8	95.6	98.4	0.6
QXP-8052R-22	52	51	1	0.65	88.1	99.6	102.4	0.6
QXP-8063R-**	63	62	1	0.55	104.2	121.6	124.4	0.6
QXP-8066R-**	66	65	1	0.5	114.6	127.6	130.4	0.6
QXP-2016-30-S16	16	15	0.8	3	15.3	27.6	30.4	0.6
QXP-3020-50-S20	20	19	0.8	2.4	19.1	35.6	38.4	0.6
QXP-4025-60-S25	25	24	0.8	1.7	27	45.6	48.4	0.6
QXP-5032-70-S32	32	31	0.8	1.2	38.2	59.6	62.4	0.5
QXP-6040-45-S32	40	39	0.8	0.95	48.2	75.6	78.4	0.6
MQX-*016-M8	16	15	0.8	3	15.3	27.6	30.4	0.6
MQX-*017-M8	17	16	0.8	3.2	14.3	29.6	32.4	0.6
MQX-*020-M10	20	19	0.8	2.4	19.1	35.6	38.4	0.6
MQX-*021-M10	21	20	0.8	2.2	20.8	37.6	40.4	0.6
MQX-*025-M12	25	24	0.8	1.7	27	45.6	48.4	0.6
MQX-*026-M12	26	25	0.8	1.6	28.6	47.6	50.4	0.6
MQX-*028-M12	28	27	0.8	1.5	30.6	51.6	54.4	0.6
MQX-*030-M16	30	29	0.8	1.3	35.3	55.6	58.4	0.5
MQX-*032-M16	32	31	0.8	1.2	38.2	59.6	62.4	0.5
MQX-*035-M16	35	34	0.8	1.1	41.7	65.6	68.4	0.5
MQX-*040-M16	40	39	0.8	0.95	48.2	75.6	78.4	0.6
MQX-*042-M16	42	41	0.8	0.85	53.9	79.6	82.4	0.6

QM MAX **MQX/QXP Type**

■ **Recommended Data for Profile Milling**

■ **ZPMT100308ZER-****

Cat.No.	Tool dia.	Effective Cutting dia.	Max.depth of cut : ap	Ramping		Helical interpolation		Max.drilling depth Z(mm)
				Max.ramping angle θ	Max.depth of cut (ap) Total cutting length L (mm)	Min.Bore dia.	Max.Bore dia.	
QXP- * 040R-16	40	38.2	1	0.95	60.3	74.8	77.6	0.6
QXP- * 050R- * *	50	48.2	1	0.7	81.8	94.8	97.6	0.6
QXP-8052R-22	52	50.2	1	0.65	88.1	98.8	101.6	0.6
QXP-8063R- * *	63	61.2	1	0.55	104.2	120.8	123.6	0.6
QXP-8066R- * *	66	64.2	1	0.5	114.6	126.8	129.6	0.6
QXP-2016-30-S16	16	14.2	0.8	3	15.3	26.8	29.6	0.6
QXP-3020-50-S20	20	18.2	0.8	2.4	19.1	34.8	37.6	0.6
QXP-4025-60-S25	25	23.2	0.8	1.7	27	44.8	47.6	0.6
QXP-5032-70-S32	32	30.2	0.8	1.2	38.2	58.8	61.6	0.5
QXP-6040-45-S32	40	38.2	0.8	0.95	48.2	74.8	77.6	0.6
MQX- * 016-M8	16	14.2	0.8	3	15.3	26.8	29.6	0.6
MQX- * 017-M8	17	15.2	0.8	3.2	14.3	28.8	31.6	0.6
MQX- * 020-M10	20	18.2	0.8	2.4	19.1	34.8	37.6	0.6
MQX- * 021-M10	21	19.2	0.8	2.2	20.8	36.8	39.6	0.6
MQX- * 025-M12	25	23.2	0.8	1.7	27	44.8	47.6	0.6
MQX- * 026-M12	26	24.2	0.8	1.6	28.6	46.8	49.6	0.6
MQX- * 028-M12	28	26.2	0.8	1.5	30.6	50.8	53.6	0.6
MQX- * 030-M16	30	28.2	0.8	1.3	35.3	54.8	57.6	0.5
MQX- * 032-M16	32	30.2	0.8	1.2	38.2	58.8	61.6	0.5
MQX- * 035-M16	35	33.2	0.8	1.1	41.7	64.8	67.6	0.5
MQX- * 040-M16	40	38.2	0.8	0.95	48.2	74.8	77.6	0.6
MQX- * 042-M16	42	40.2	0.8	0.85	53.9	78.8	81.6	0.6

■ **ZPMT100320ZER-****

Cat.No.	Tool dia.	Effective Cutting dia.	Max.depth of cut : ap	Ramping		Helical interpolation		Max.drilling depth Z(mm)
				Max.ramping angle θ	Max.depth of cut (ap) Total cutting length L (mm)	Min.Bore dia.	Max.Bore dia.	
QXP- * 040R-16	40	35.8	1	0.95	60.3	70	75.2	0.6
QXP- * 050R- * *	50	45.8	1	0.7	81.8	90	95.2	0.6
QXP-8052R-22	52	47.8	1	0.65	88.1	94	99.2	0.6
QXP-8063R- * *	63	58.8	1	0.55	104.2	116	121.2	0.6
QXP-8066R- * *	66	61.8	1	0.5	114.6	122	127.2	0.6
QXP-2016-30-S16	16	11.8	0.8	3	15.3	22	27.2	0.6
QXP-3020-50-S20	20	15.8	0.8	2.4	19.1	30	35.2	0.6
QXP-4025-60-S25	25	20.8	0.8	1.7	27	40	45.2	0.6
QXP-5032-70-S32	32	27.8	0.8	1.2	38.2	54	59.2	0.5
QXP-6040-45-S32	40	35.8	0.8	0.95	48.2	70	75.2	0.6
MQX- * 016-M8	16	11.8	0.8	3	15.3	22	27.2	0.6
MQX- * 017-M8	17	12.8	0.8	3.2	14.3	24	29.2	0.6
MQX- * 020-M10	20	15.8	0.8	2.4	19.1	30	35.2	0.6
MQX- * 021-M10	21	16.8	0.8	2.2	20.8	32	37.2	0.6
MQX- * 025-M12	25	20.8	0.8	1.7	27	40	45.2	0.6
MQX- * 026-M12	26	21.8	0.8	1.6	28.6	42	47.2	0.6
MQX- * 028-M12	28	23.8	0.8	1.5	30.6	46	51.2	0.6
MQX- * 030-M16	30	25.8	0.8	1.3	35.3	50	55.2	0.5
MQX- * 032-M16	32	27.8	0.8	1.2	38.2	54	59.2	0.5
MQX- * 035-M16	35	30.8	0.8	1.1	41.7	60	65.2	0.5
MQX- * 040-M16	40	35.8	0.8	0.95	48.2	70	75.2	0.6
MQX- * 042-M16	42	37.8	0.8	0.85	53.9	74	79.2	0.6

QM MAX**MQX/QXP Type****YPHW100303ZER-15**

Cat.No.	Tool dia.	Effective Cutting dia.	Max.depth of cut : ap	Ramping		Helical interpolation		Max.drilling depth Z(mm)
				Max.ramping angle θ	Max.depth of cut (ap) Total cutting length L (mm)	Min.Bore dia.	Max.Bore dia.	
QXP- *040R-16	40	39.3	0.3	1	17.2	77	78.7	0.3
QXP- *050R- * *	50	49.3	0.3	0.75	22.9	97	98.7	0.3
QXP-8052R-22	52	51.3	0.3	0.7	24.6	101	102.7	0.3
QXP-8063R- * *	63	62.3	0.3	0.6	28.6	123	124.7	0.3
QXP-8066R- * *	66	65.3	0.3	0.55	31.3	129	130.7	0.3
QXP-2016-30-S16	16	15.3	0.3	1.3	13.2	29	30.7	0.2
QXP-3020-50-S20	20	19.3	0.3	2.1	8.2	37	38.7	0.3
QXP-4025-60-S25	25	24.3	0.3	1.8	9.5	47	48.7	0.3
QXP-5032-70-S32	32	31.3	0.3	1.3	13.2	61	62.7	0.3
QXP-6040-45-S32	40	39.3	0.3	1	17.2	77	78.7	0.3
MQX- *016-M8	16	15.3	0.3	1.3	13.2	29	30.7	0.2
MQX- *017-M8	17	16.3	0.3	1.7	10.1	31	32.7	0.3
MQX- *020-M10	20	19.3	0.3	2.1	8.2	37	38.7	0.3
MQX- *021-M10	21	20.3	0.3	2.4	7.2	39	40.7	0.3
MQX- *025-M12	25	24.3	0.3	1.8	9.5	47	48.7	0.3
MQX- *026-M12	26	25.3	0.3	1.7	10.1	49	50.7	0.3
MQX- *028-M12	28	27.3	0.3	1.6	10.7	53	54.7	0.3
MQX- *030-M16	30	29.3	0.3	1.4	12.3	57	58.7	0.3
MQX- *032-M16	32	31.3	0.3	1.3	13.2	61	62.7	0.3
MQX- *035-M16	35	34.3	0.3	1.2	14.3	67	68.7	0.3
MQX- *040-M16	40	39.3	0.3	1	17.2	77	78.7	0.3
MQX- *042-M16	42	41.3	0.3	0.9	19.1	81	82.7	0.3

YPHW100308ZER-15

Cat.No.	Tool dia.	Effective Cutting dia.	Max.depth of cut : ap	Ramping		Helical interpolation		Max.drilling depth Z(mm)
				Max.ramping angle θ	Max.depth of cut (ap) Total cutting length L (mm)	Min.Bore dia.	Max.Bore dia.	
QXP- *040R-16	40	38.3	0.3	1	17.2	75	77.7	0.3
QXP- *050R- * *	50	48.3	0.3	0.75	22.9	95	97.7	0.3
QXP-8052R-22	52	50.3	0.3	0.7	24.6	99	101.7	0.3
QXP-8063R- * *	63	61.3	0.3	0.6	28.6	121	123.7	0.3
QXP-8066R- * *	66	64.3	0.3	0.55	31.3	127	129.7	0.3
QXP-2016-30-S16	16	14.3	0.3	1.4	12.3	27	29.7	0.2
QXP-3020-50-S20	20	18.3	0.3	2.2	7.8	35	37.7	0.3
QXP-4025-60-S25	25	23.3	0.3	1.9	9	45	47.7	0.3
QXP-5032-70-S32	32	30.3	0.3	1.4	12.3	59	61.7	0.3
QXP-6040-45-S32	40	38.3	0.3	1	17.2	75	77.7	0.3
MQX- *016-M8	16	14.3	0.3	1.4	12.3	27	29.7	0.2
MQX- *017-M8	17	15.3	0.3	1.8	9.5	29	31.7	0.3
MQX- *020-M10	20	18.3	0.3	2.2	7.8	35	37.7	0.3
MQX- *021-M10	21	19.3	0.3	2.5	6.9	37	39.7	0.3
MQX- *025-M12	25	23.3	0.3	1.9	9	45	47.7	0.3
MQX- *026-M12	26	24.3	0.3	1.8	9.5	47	49.7	0.3
MQX- *028-M12	28	26.3	0.3	1.7	10.1	51	53.7	0.3
MQX- *030-M16	30	28.3	0.3	1.5	11.5	55	57.7	0.3
MQX- *032-M16	32	30.3	0.3	1.4	12.3	59	61.7	0.3
MQX- *035-M16	35	33.3	0.3	1.2	14.3	65	67.7	0.3
MQX- *040-M16	40	38.3	0.3	1	17.2	75	77.7	0.3
MQX- *042-M16	42	40.3	0.3	0.9	19.1	79	81.7	0.3

QM MAX**MQX/QXP Type**

■ Recommended Data for Profile Milling

■ **YPHW100320ZER-24**

Cat.No.	Tool dia.	Effective Cutting dia.	Max.depth of cut : ap	Ramping		Helical interpolation		Max.drilling depth Z(mm)
				Max.ramping angle θ	Max.depth of cut (ap) Total cutting length L (mm)	Min.Bore dia.	Max.Bore dia.	
QXP- *040R-16	40	35.9	0.3	1.1	15.6	70.2	75.3	0.3
QXP- *050R- * *	50	45.9	0.3	0.9	19.1	90.2	95.3	0.3
QXP-8052R-22	52	47.9	0.3	0.85	20.2	94.2	99.3	0.3
QXP-8063R- * *	63	58.9	0.3	0.65	26.4	116.2	121.3	0.3
QXP-8066R- * *	66	61.9	0.3	0.65	26.4	122.2	127.3	0.3
QXP-2016-30-S16	16	11.9	0.3	1.9	9	22.2	27.3	0.3
QXP-3020-50-S20	20	15.9	0.3	2.5	6.9	30.2	35.3	0.3
QXP-4025-60-S25	25	20.9	0.3	2.2	7.8	40.2	45.3	0.3
QXP-5032-70-S32	32	27.9	0.3	1.5	11.5	54.2	59.3	0.3
QXP-6040-45-S32	40	35.9	0.3	1.1	15.6	70.2	75.3	0.3
MQX- *016-M8	16	11.9	0.3	1.9	9	22.2	27.3	0.3
MQX- *017-M8	17	12.9	0.3	2.2	7.8	24.2	29.3	0.3
MQX- *020-M10	20	15.9	0.3	2.5	6.9	30.2	35.3	0.3
MQX- *021-M10	21	16.9	0.3	2.8	6.1	32.2	37.3	0.3
MQX- *025-M12	25	20.9	0.3	2.2	7.8	40.2	45.3	0.3
MQX- *026-M12	26	21.9	0.3	2	8.6	42.2	47.3	0.3
MQX- *028-M12	28	23.9	0.3	1.8	9.5	46.2	51.3	0.3
MQX- *030-M16	30	25.9	0.3	1.6	10.7	50.2	55.3	0.3
MQX- *032-M16	32	27.9	0.3	1.5	11.5	54.2	59.3	0.3
MQX- *035-M16	35	30.9	0.3	1.4	12.3	60.2	65.3	0.3
MQX- *040-M16	40	35.9	0.3	1.1	15.6	70.2	75.3	0.3
MQX- *042-M16	42	37.9	0.3	1.1	15.6	74.2	79.3	0.3

QM MAX**MQX/QXP Type**

■ Recommended cutting conditions

● MQX Type (EPMT/W insert) + MSN shank

①

Material	Grade	Tool dia.(mm)														
		16/17					20					20/21				
		2N					3N					4N				
		ℓ (mm)	ap (mm)	ae (mm)	n (min ⁻¹)	Vf (mm/min)	ℓ (mm)	ap (mm)	ae (mm)	n (min ⁻¹)	Vf (mm/min)	ℓ (mm)	ap (mm)	ae (mm)	n (min ⁻¹)	Vf (mm/min)
Carbon steel (S50C, S55C) below 250HB	JC7560 (JC8050)	~70	0.6	~10	3,600	4,900	~70	0.6	~14	2,850	5,800	~70	0.6	~14	2,850	7,700
	(JC8118)	120	0.5	~10	3,600	4,500	120	0.5	~14	2,850	5,300	120	0.5	~14	2,850	7,000
		160	0.35	~10	3,000	4,200	190	0.35	~14	2,400	4,900	190	0.35	~14	2,400	6,500
Tool & die steel (SKD61, SKD11) below 255HB	JC7560 (JC8050)	~70	0.6	~10	3,600	4,900	~70	0.6	~14	2,850	5,800	~70	0.6	~14	2,850	7,700
	(JC8118)	120	0.5	~10	3,600	4,500	120	0.5	~14	2,850	5,300	120	0.5	~14	2,850	7,000
		160	0.35	~10	3,000	4,200	190	0.35	~14	2,400	4,900	190	0.35	~14	2,400	6,500
Mold steel (HPM7, PX5, P20) 30-36 HRC	JC8118 (JC7560)	~70	0.6	~10	3,600	4,900	~70	0.6	~14	2,850	5,800	~70	0.6	~14	2,850	7,700
	(JC8050)	120	0.5	~10	3,600	4,500	120	0.5	~14	2,850	5,300	120	0.5	~14	2,850	7,000
		160	0.35	~10	3,000	4,200	190	0.35	~14	2,400	4,900	190	0.35	~14	2,400	6,500
Mold steel (NAK80, HPM1, P21) 38-43HRC	JC8118 (JC8050)	~70	0.5	~10	1,900	2,600	~70	0.5	~14	1,500	3,050	~70	0.5	~14	1,500	4,050
		120	0.3	~10	1,900	2,400	120	0.3	~14	1,500	2,800	120	0.3	~14	1,500	3,700
		160	0.2	~10	1,600	2,200	190	0.2	~14	1,250	2,600	190	0.2	~14	1,250	3,400
Hardened die steel (SKD61, DAC, DHA) 42-52HRC	JC8118 (JC8050)	~70	0.4	~10	1,400	1,400	~70	0.4	~14	1,100	1,650	~70	0.4	~14	1,100	2,200
		120	0.3	~10	1,400	1,400	120	0.3	~14	1,100	1,650	120	0.3	~14	1,100	2,200
		160	—	—	—	—	190	—	—	—	—	190	—	—	—	—
Hardened die steel (SKD11, SL, DC11) 55-62HRC	JC8118 EPMWType	~70	0.15	~10	600	180	~70	0.15	~14	500	230	~70	0.15	~14	500	300
		120	0.1	~10	600	180	120	0.1	~14	500	230	120	0.1	~14	500	300
		160	—	—	—	—	190	—	—	—	—	190	—	—	—	—
Gery & Nodular cast iron (FC, FCD) below 300HB	JC8118 (JC7560)	~70	0.8	~10	3,000	5,000	~70	0.8	~14	2,400	6,000	~70	0.8	~14	2,400	8,000
		120	0.6	~10	3,000	4,500	120	0.6	~14	2,400	5,400	120	0.6	~14	2,400	7,200
		160	0.5	~10	2,200	3,750	190	0.5	~14	1,750	4,500	190	0.5	~14	1,750	6,000
Stainless steel (SUS304) below 250HB	JC8050 (JC7560)	~70	0.6	~10	3,100	4,200	~70	0.6	~14	2,500	5,100	~70	0.6	~14	2,500	6,800
		120	0.5	~10	3,000	4,000	120	0.5	~14	2,400	4,900	120	0.5	~14	2,400	6,500
		160	0.35	~10	3,000	4,000	190	0.35	~14	2,400	4,900	190	0.35	~14	2,400	6,500
Titanium alloy (Ti-6Al-4V)	DS150 (DS118)	~70	0.5	~10	1,200	960	~70	0.5	~14	950	1,140	~70	0.5	~14	950	1,500
	(JC8050)	120	0.3	~10	1,200	960	120	0.3	~14	950	1,140	120	0.3	~14	950	1,500
		160	0.2	~10	1,200	960	190	0.2	~14	950	1,140	190	0.2	~14	950	1,500
Heat resistant alloy (INCO718)	JC8118 (DS118)	~70	0.5	~10	630	380	~70	0.5	~14	500	450	~70	0.5	~14	500	600
	(DS150)	120	0.3	~10	630	380	120	0.3	~14	500	450	120	0.3	~14	500	600
		160	0.2	~10	630	380	190	0.2	~14	500	450	190	0.2	~14	500	600

Note

1. Please adjust cutting conditions according to machine rigidity or work rigidity.
2. In case of chatter occurring, recommended to reduce ap or rpm and keep feed per tooth.
3. ap should be reduced when using on low rigidity machine.
4. Use air blow.
5. When using ZPMT100320ZER-PL insert for High feed milling, reduce cutting conditions above by 10-30%.
6. When using Endmill type, reduce cutting conditions above by 10-20%.

QM MAX **MQX/QXP Type**

- Recommended cutting conditions
- MQX Type (EPMT/W insert) + MSN shank

1

Material	Grade	Tool dia.(mm)									
		25/26					25/26/28				
		4N					5N				
		ℓ (mm)	ap (mm)	ae (mm)	n (min ⁻¹)	Vf (mm/min)	ℓ (mm)	ap (mm)	ae (mm)	n (min ⁻¹)	Vf (mm/min)
Carbon steel (S50C, S55C) below 250HB	JC7560 (JC8050) (JC8118)	~90	0.8	~19	2,300	6,200	~90	0.8	~19	2,300	7,700
		140	0.6	~19	2,300	5,600	140	0.6	~19	2,300	7,000
		210	0.4	~19	1,900	5,200	210	0.4	~19	1,900	6,500
Tool & die steel (SKD61, SKD11) below 255HB	JC7560 (JC8050) (JC8118)	~90	0.8	~19	2,300	6,200	~90	0.8	~19	2,300	7,700
		140	0.6	~19	2,300	5,600	140	0.6	~19	2,300	7,000
		210	0.4	~19	1,900	5,200	210	0.4	~19	1,900	6,500
Mold steel (HPM7, PX5, P20) 30-36 HRC	JC8118 (JC7560) (JC8050)	~90	0.8	~19	2,300	6,200	~90	0.8	~19	2,300	7,700
		140	0.6	~19	2,300	5,600	140	0.6	~19	2,300	7,000
		210	0.4	~19	1,900	5,200	210	0.4	~19	1,900	6,500
Mold steel (NAK80, HPM1, P21) 38-43HRC	JC8118 (JC8050)	~90	0.6	~19	1,200	3,250	~90	0.6	~19	1,200	4,050
		140	0.4	~19	1,200	3,000	140	0.4	~19	1,200	3,700
		210	0.3	~19	1,000	2,700	210	0.3	~19	1,000	3,400
Hardened die steel (SKD61, DAC, DHA) 42-52HRC	JC8118 (JC8050)	~90	0.4	~19	900	1,800	~90	0.4	~19	900	2,250
		140	0.3	~19	900	1,800	140	0.3	~19	900	2,250
		210	—	—	—	—	210	—	—	—	—
Hardened die steel (SKD11, SLD, DC11) 55-62HRC	JC8118 EPMWType	~90	0.15	~19	400	240	~90	0.15	~19	400	300
		140	0.1	~19	400	240	140	0.1	~19	400	300
		210	—	—	—	—	210	—	—	—	—
Gery & Nodular cast iron (FC, FCD) below 300HB	JC8118 (JC7560)	~90	0.8	~19	1,900	6,400	~90	0.8	~19	1,900	8,000
		140	0.6	~19	1,900	5,800	140	0.6	~19	1,900	7,200
		210	0.5	~19	1,600	4,800	210	0.5	~19	1,600	6,000
Stainless steel (SUS304) below 250HB	JC8050 (JC7560)	~90	0.8	~19	2,000	5,450	~90	0.8	~19	2,000	6,800
		140	0.6	~19	2,000	5,200	140	0.6	~19	2,000	6,500
		210	0.35	~19	1,900	4,950	210	0.35	~19	1,900	6,200
Titanium alloy (Ti-6Al-4V)	DS150 (DS118) (JC8050)	~90	0.5	~19	750	1,200	~90	0.5	~19	750	1,500
		140	0.3	~19	750	1,200	140	0.3	~19	750	1,500
		210	0.2	~19	750	1,200	210	0.2	~19	750	1,500
Heat resistant alloy (INCO718)	JC8118 (DS118) (DS150)	~90	0.5	~19	400	480	~90	0.5	~19	400	600
		140	0.3	~19	400	480	140	0.3	~19	400	600
		210	0.2	~19	400	480	210	0.2	~19	400	600

Note

1. Please adjust cutting conditions according to machine rigidity or work rigidity.
2. In case of chatter occurring, recommended to reduce ap or rpm and keep feed per tooth.
3. ap should be reduced when using on low rigidity machine.
4. Use air blow.
5. When using ZPMT100320ZER-PL insert for High feed milling, reduce cutting conditions above by 10-30%.
6. When using Endmill type, reduce cutting conditions above by 10-20%.

QM MAX**MQX/QXP Type**

■ Recommended cutting conditions

● MQX Type (EPMT/W insert) + MSN shank

①

Material	Grade	Tool dia.(mm)									
		30/32/35					32/35				
		5N					6N				
		ϕ (mm)	a_p (mm)	a_e (mm)	n (min ⁻¹)	V_f (mm/min)	ϕ (mm)	a_p (mm)	a_e (mm)	n (min ⁻¹)	V_f (mm/min)
Carbon steel (S50C, S55C) below 250HB	JC7560	~100	0.8	~25	1,900	6,350	~100	0.8	~25	1,900	7,600
	(JC8050)	150	0.6	~25	1,800	6,000	150	0.6	~25	1,800	7,200
	(JC8118)	210	0.4	~25	1,500	5,000	210	0.4	~25	1,500	6,000
Tool & die steel (SKD61, SKD11) below 255HB	JC7560	~100	0.8	~25	1,900	6,350	~100	0.8	~25	1,900	7,600
	(JC8050)	150	0.6	~25	1,800	6,000	150	0.6	~25	1,800	7,200
	(JC8118)	210	0.4	~25	1,500	5,000	210	0.4	~25	1,500	6,000
Mold steel (HPM7, PX5, P20) 30-36 HRC	JC8118	~100	0.8	~25	1,900	6,350	~100	0.8	~25	1,900	7,600
	(JC7560)	150	0.6	~25	1,800	6,000	150	0.6	~25	1,800	7,200
	(JC8050)	210	0.4	~25	1,500	5,000	210	0.4	~25	1,500	6,000
Mold steel (NAK80, HPM1, P21) 38-43HRC	JC8118	~100	0.6	~25	950	3,200	~100	0.6	~25	950	3,800
	(JC7560)	150	0.4	~25	950	3,200	150	0.4	~25	950	3,800
	(JC8050)	210	0.3	~25	800	2,650	210	0.3	~25	800	3,200
Hardened die steel (SKD61, DAC, DHA) 42-52HRC	JC8118	~100	0.4	~25	700	1,750	~100	0.4	~25	700	2,100
	(JC8050)	150	0.3	~25	700	1,750	150	0.3	~25	700	2,100
		210	—	—	—	—	210	—	—	—	—
Hardened die steel (SKD11, SL, DC11) 55-62HRC	JC8118	~100	0.15	~25	300	250	~100	0.15	~25	300	300
	(JC7560)	150	0.1	~25	300	250	150	0.1	~25	300	300
	EPMTType	210	—	—	—	—	210	—	—	—	—
Grey & Nodular cast iron (FC, FCD) below 300HB	JC8118	~100	1	~25	1,500	6,250	~100	1	~25	1,500	7,500
	(JC7560)	150	0.8	~25	1,500	5,750	150	0.8	~25	1,500	6,900
		210	0.6	~25	1,250	4,850	210	0.6	~25	1,250	5,800
Stainless steel (SUS304) below 250HB	JC8050	~100	0.8	~25	1,700	5,700	~100	0.8	~25	1,700	6,800
	(JC7560)	150	0.6	~25	1,600	5,350	150	0.6	~25	1,600	6,400
		210	0.35	~25	1,500	5,000	210	0.35	~25	1,500	6,000
Titanium alloy (Ti-6Al-4V)	DS150	~100	0.5	~25	600	1,250	~100	0.5	~25	600	1,500
	(DS118)	150	0.3	~25	600	1,250	150	0.3	~25	600	1,500
	(JC8050)	210	0.2	~25	600	1,250	210	0.2	~25	600	1,500
Heat resistant alloy (INCO718)	JC8118	~100	0.5	~25	300	500	~100	0.5	~25	300	580
	(DS118)	150	0.3	~25	300	500	150	0.3	~25	300	580
	(DS150)	210	0.2	~25	300	500	210	0.2	~25	300	580

Note

1. Please adjust cutting conditions according to machine rigidity or work rigidity.
2. In case of chatter occurring, recommended to reduce a_p or rpm and keep feed per tooth.
3. a_p should be reduced when using on low rigidity machine.
4. Use air blow.
5. When using ZPMT100320ZER-PL insert for High feed milling, reduce cutting conditions above by 10-30%.
6. When using Endmill type, reduce cutting conditions above by 10-20%.

QM MAX

MQX/QXP Type

- Recommended cutting conditions
- MQX Type (EPMT/W insert) + MSN shank

1

Material	Grade	Tool dia.(mm)									
		40/42					40				
		6N					7N				
		ℓ (mm)	ap (mm)	ae (mm)	n (min ⁻¹)	Vf (mm/min)	ℓ (mm)	ap (mm)	ae (mm)	n (min ⁻¹)	Vf (mm/min)
Carbon steel (S50C, S55C) below 250HB	JC7560	~100	0.8	~32	1,500	6,300	~100	0.8	~32	1,500	7,500
	(JC8050)	150	0.6	~32	1,400	5,900	150	0.6	~32	1,400	7,000
	(JC8118)	210	0.4	~32	1,200	5,000	210	0.4	~32	1,200	6,000
Tool & die steel (SKD61, SKD11) below 255HB	JC7560	~100	0.8	~32	1,500	6,300	~100	0.8	~32	1,500	7,500
	(JC8050)	150	0.6	~32	1,400	5,900	150	0.6	~32	1,400	7,000
	(JC8118)	210	0.4	~32	1,200	5,000	210	0.4	~32	1,200	6,000
Mold steel (HPM7, PX5, P20) 30-36 HRC	JC8118	~100	0.8	~32	1,500	6,300	~100	0.8	~32	1,500	7,500
	(JC7560)	150	0.6	~32	1,400	5,900	150	0.6	~32	1,400	7,000
	(JC8050)	210	0.4	~32	1,200	5,000	210	0.4	~32	1,200	6,000
Mold steel (NAK80, HPM1, P21) 38-43HRC	JC8118	~100	0.6	~32	750	3,000	~100	0.6	~32	750	3,500
	(JC8050)	150	0.4	~32	750	3,000	150	0.4	~32	750	3,500
		210	0.3	~32	620	2,500	210	0.3	~32	620	2,900
Hardened die steel (SKD61, DAC, DHA) 42-52HRC	JC8118	~100	0.4	~32	550	1,650	~100	0.4	~32	550	1,900
	(JC8050)	150	0.3	~32	550	1,650	150	0.3	~32	550	1,900
		210	—	—	—	—	210	—	—	—	—
Hardened die steel (SKD11, SLD, DC11) 55-62HRC	JC8118	~100	0.15	~32	250	240	~100	0.15	~32	250	280
	EPMTType	150	0.1	~32	250	240	150	0.1	~32	250	280
		210	—	—	—	—	210	—	—	—	—
Gery & Nodular cast iron (FC, FCD) below 300HB	JC8118	~100	1	~32	1,200	6,150	~100	1	~32	1,200	7,200
	(JC7560)	150	0.8	~32	1,200	5,650	150	0.8	~32	1,200	6,600
		210	0.6	~32	1,000	4,700	210	0.6	~32	1,000	5,500
Stainless steel (SUS304) below 250HB	JC8050	~100	0.8	~32	1,350	5,850	~100	0.8	~32	1,350	6,800
	(JC7560)	150	0.6	~32	1,300	5,550	150	0.6	~32	1,300	6,500
		210	0.35	~32	1,200	5,150	210	0.35	~32	1,200	6,000
Titanium alloy (Ti-6Al-4V)	DS150	~100	0.5	~32	480	1,150	~100	0.5	~32	480	1,350
	(DS118)	150	0.3	~32	480	1,150	150	0.3	~32	480	1,350
	(JC8050)	210	0.2	~32	480	1,150	210	0.2	~32	480	1,350
Heat resistant alloy (INCO718)	JC8118	~100	0.5	~32	250	450	~100	0.5	~32	250	520
	(DS118)	150	0.3	~32	250	450	150	0.3	~32	250	520
	(DS150)	210	0.2	~32	250	450	210	0.2	~32	250	520

Note

1. Please adjust cutting conditions according to machine rigidity or work rigidity.
2. In case of chatter occurring, recommended to reduce ap or rpm and keep feed per tooth.
3. ap should be reduced when using on low rigidity machine.
4. Use air blow.
5. When using ZPMT100320ZER-PL insert for High feed milling, reduce cutting conditions above by 10-30%.
6. When using Endmill type, reduce cutting conditions above by 10-20%.

QM MAX**MQX/QXP Type**

■ Recommended cutting conditions

● QXP Type (EPMT/W insert)

①

Material	Grade	protrusion length ℓ (mm)	Tool dia.(mm)							
			40							
			6N				7N			
			a _p (mm)	a _e (mm)	n (min ⁻¹)	V _f (mm/min)	a _p (mm)	a _e (mm)	n (min ⁻¹)	V _f (mm/min)
Carbon steel (S50C, S55C) below 250HB	JC7560 (JC8050) (JC8118)	~150	0.8	~32	1,250	6,000	0.8	~32	1,250	7,000
		200	0.6	~32	1,100	5,300	0.6	~32	1,100	6,200
		250	0.5	~32	1,000	4,800	0.5	~32	1,000	5,600
		300	—	—	—	—	—	—	—	—
		350	—	—	—	—	—	—	—	—
Tool & die steel (SKD61, SKD11) below 255HB	JC7560 (JC8050) (JC8118)	~150	0.8	~32	1,250	6,000	0.8	~32	1,250	7,000
		200	0.6	~32	1,100	5,300	0.6	~32	1,100	6,200
		250	0.5	~32	1,000	4,800	0.5	~32	1,000	5,600
		300	—	—	—	—	—	—	—	—
		350	—	—	—	—	—	—	—	—
Mold steel (HPM7, PX5, P20) 30-36 HRC	JC8118 (JC7560) (JC8050)	~150	0.8	~32	1,250	6,000	0.8	~32	1,250	7,000
		200	0.6	~32	1,100	5,300	0.6	~32	1,100	6,200
		250	0.5	~32	1,000	4,800	0.5	~32	1,000	5,600
		300	—	—	—	—	—	—	—	—
		350	—	—	—	—	—	—	—	—
Mold steel (NAK80, HPM1, P21) 38-43HRC	JC8118 (JC8050)	~150	0.6	~32	680	2,850	0.6	~32	680	3,300
		200	0.4	~32	640	2,650	0.4	~32	640	3,100
		250	0.3	~32	600	2,500	0.3	~32	600	2,900
		300	—	—	—	—	—	—	—	—
		350	—	—	—	—	—	—	—	—
Hardened die steel (SKD61, DAC, DHA) 42-52HRC	JC8118 (JC8050)	~150	0.4	~32	520	1,550	0.4	~32	520	1,800
		200	0.2	~32	520	1,550	0.2	~32	520	1,800
		250	—	—	—	—	—	—	—	—
		300	—	—	—	—	—	—	—	—
		350	—	—	—	—	—	—	—	—
Hardened die steel (SKD11, SLD, DC11) 55-62HRC	JC8118 EPMWType	~150	0.15	~32	240	230	0.15	~32	240	270
		200	0.1	~32	220	210	0.1	~32	220	250
		250	—	—	—	—	—	—	—	—
		300	—	—	—	—	—	—	—	—
		350	—	—	—	—	—	—	—	—
Gery & Nodular Cast iron (FC, FCD) below 300HB	JC8118 (JC7560)	~150	0.8	~32	1,100	6,600	0.8	~32	1,100	7,700
		200	0.6	~32	1,000	6,000	0.6	~32	1,000	7,000
		250	0.5	~32	900	5,400	0.5	~32	900	6,300
		300	—	—	—	—	—	—	—	—
		350	—	—	—	—	—	—	—	—
Stainless steel (SUS304) below 250HB	JC8050 (JC7560)	~150	0.6	~32	1,200	5,400	0.6	~32	1,200	6,300
		200	0.4	~32	1,100	4,950	0.4	~32	1,100	5,800
		250	0.3	~32	1,000	4,450	0.3	~32	1,000	5,200
		300	—	—	—	—	—	—	—	—
		350	—	—	—	—	—	—	—	—
Titanium alloy (Ti-6Al-4V)	DS150 (DS118) (JC8050)	~150	0.6	~32	480	1,150	0.6	~32	480	1,350
		200	0.4	~32	440	1,050	0.4	~32	440	1,230
		250	0.3	~32	440	1,050	0.3	~32	440	1,230
		300	—	—	—	—	—	—	—	—
		350	—	—	—	—	—	—	—	—
Heat resistant alloy (INCO718)	JC8118 (DS118) (DS150)	~150	0.6	~32	240	430	0.6	~32	240	500
		200	0.4	~32	200	360	0.4	~32	200	420
		250	0.3	~32	200	360	0.3	~32	200	420
		300	—	—	—	—	—	—	—	—
		350	—	—	—	—	—	—	—	—

QM MAX

MQX/QXP Type

■ Recommended cutting conditions

● QXP Type (EPMT/W insert)

①

Material	Grade	protrusion length l _p (mm)	Tool dia. (mm)							
			50				50/52			
			7N				8N			
			a _p (mm)	a _e (mm)	n (min ⁻¹)	V _f (mm/min)	a _p (mm)	a _e (mm)	n (min ⁻¹)	V _f (mm/min)
Carbon steel (S50C, S55C) below 250HB	JC7560 (JC8050) (JC8118)	~150	1	~40	1,000	6,300	1	~40	1,000	7,200
		200	0.8	~40	1,000	5,950	0.8	~40	1,000	6,800
		250	0.6	~40	900	5,350	0.6	~40	900	6,100
		300	0.5	~40	800	4,750	0.5	~40	800	5,450
		350	0.4	~40	800	4,750	0.4	~40	800	5,450
Tool & die steel (SKD61, SKD11) below 255HB	JC7560 (JC8050) (JC8118)	~150	1	~40	1,000	6,300	1	~40	1,000	7,200
		200	0.8	~40	1,000	5,950	0.8	~40	1,000	6,800
		250	0.6	~40	900	5,350	0.6	~40	900	6,100
		300	0.5	~40	800	4,750	0.5	~40	800	5,450
		350	0.4	~40	800	4,750	0.4	~40	800	5,450
Mold steel (HPM7, PX5, P20) 30-36 HRC	JC8118 (JC7560) (JC8050)	~150	1	~40	1,000	6,300	1	~40	1,000	7,200
		200	0.8	~40	1,000	5,950	0.8	~40	1,000	6,800
		250	0.6	~40	900	5,350	0.6	~40	900	6,100
		300	0.5	~40	800	4,750	0.5	~40	800	5,450
		350	0.4	~40	800	4,750	0.4	~40	800	5,450
Mold steel (NAK80, HPM1, P21) 38-43HRC	JC8118 (JC8050)	~150	0.8	~40	540	2,600	0.8	~40	540	3,000
		200	0.6	~40	540	2,600	0.6	~40	540	3,000
		250	0.4	~40	510	2,500	0.4	~40	510	2,850
		300	0.3	~40	480	2,350	0.3	~40	480	2,700
		350	0.3	~40	480	2,000	0.3	~40	480	2,300
Hardened die steel (SKD61, DAC, DHA) 42-52HRC	JC8118 (JC8050)	~150	0.6	~40	400	1,400	0.6	~40	400	1,600
		200	0.4	~40	400	1,400	0.4	~40	400	1,600
		250	0.2	~40	400	1,400	0.2	~40	400	1,600
		300	—	—	—	—	—	—	—	—
		350	—	—	—	—	—	—	—	—
Hardened die steel (SKD11, SLD, DC11) 55-62HRC	JC8118 EPMTType	~150	0.15	~40	190	210	0.15	~40	190	240
		200	0.15	~40	170	190	0.15	~40	170	220
		250	0.1	~40	170	190	0.1	~40	170	220
		300	—	—	—	—	—	—	—	—
		350	—	—	—	—	—	—	—	—
Gery & Nodular Cast iron (FC, FCD) below 300HB	JC8118 (JC7560)	~150	1	~40	900	7,500	1	~40	900	8,600
		200	0.8	~40	900	6,300	0.8	~40	900	7,200
		250	0.6	~40	850	5,950	0.6	~40	850	6,800
		300	0.5	~40	800	5,600	0.5	~40	800	6,400
		350	0.4	~40	800	5,600	0.4	~40	800	6,400
Stainless steel (SUS304) below 250HB	JC8050 (JC7560)	~150	0.8	~40	950	5,600	0.8	~40	950	6,400
		200	0.6	~40	950	5,000	0.6	~40	950	5,700
		250	0.4	~40	900	4,700	0.4	~40	900	5,400
		300	0.3	~40	900	4,700	0.3	~40	900	5,400
		350	0.3	~40	850	4,450	0.3	~40	850	5,100
Titanium alloy (Ti-6Al-4V)	DS150 (DS118) (JC8050)	~150	0.8	~40	380	1,050	0.8	~40	380	1,220
		200	0.6	~40	380	1,050	0.6	~40	380	1,220
		250	0.4	~40	350	980	0.4	~40	350	1,120
		300	0.3	~40	350	980	0.3	~40	350	1,120
		350	0.3	~40	320	890	0.3	~40	320	1,020
Heat resistant alloy (INCO718)	JC8118 (DS118) (DS150)	~150	0.8	~40	190	390	0.8	~40	190	450
		200	0.6	~40	190	390	0.6	~40	190	450
		250	0.4	~40	160	330	0.4	~40	160	380
		300	0.3	~40	160	330	0.3	~40	160	380
		350	0.3	~40	130	270	0.3	~40	130	310

QM MAX**MQX/QXP Type**

■ Recommended cutting conditions

● QXP Type (EPMT/W insert)

①

Material	Grade	protrusion length l (mm)	Tool dia.(mm)			
			63/66			
			8N			
			a_p (mm)	a_e (mm)	n (min ⁻¹)	V_f (mm/min)
Carbon steel (S50C, S55C) below 250HB	JC7560 (JC8050) (JC8118)	~200	1	~50	800	5,750
		250	0.8	~50	800	5,450
		300	0.6	~50	720	4,900
		350	0.5	~50	640	4,350
		400	0.4	~50	640	4,350
Tool & die steel (SKD61, SKD11) below 255HB	JC7560 (JC8050) (JC8118)	~200	1	~50	800	5,750
		250	0.8	~50	800	5,450
		300	0.6	~50	720	4,900
		350	0.5	~50	640	4,350
		400	0.4	~50	640	4,350
Mold steel (HPM7, PX5, P20) 30-36 HRC	JC8118 (JC7560) (JC8050)	~200	1	~50	800	5,750
		250	0.8	~50	800	5,450
		300	0.6	~50	720	4,900
		350	0.5	~50	640	4,350
		400	0.4	~50	640	4,350
Mold steel (NAK80, HPM1, P21) 38-43HRC	JC8118 (JC8050)	~200	0.8	~50	430	2,400
		250	0.6	~50	430	2,400
		300	0.4	~50	410	2,300
		350	0.3	~50	370	2,100
		400	0.3	~50	370	1,800
Hardened die steel (SKD61, DAC, DHA) 42-52HRC	JC8118 (JC8050)	~200	0.6	~50	320	1,300
		250	0.4	~50	320	1,300
		300	0.2	~50	320	1,300
		350	—	—	—	—
		400	—	—	—	—
Hardened die steel (SKD11, SLD, DC11) 55-62HRC	JC8118 EPMWType	~200	0.15	~50	150	190
		250	0.15	~50	130	170
		300	0.1	~50	130	170
		350	—	—	—	—
		400	—	—	—	—
Grey & Nodular cast iron (FC, FCD) below 300HB	JC8118 (JC7560)	~200	1	~50	720	6,900
		250	0.8	~50	720	5,750
		300	0.6	~50	680	5,450
		350	0.5	~50	640	5,100
		400	0.4	~50	640	5,100
Stainless steel (SUS304) below 250HB	JC8050 (JC7560)	~200	0.8	~50	750	5,050
		250	0.6	~50	750	4,500
		300	0.4	~50	710	4,250
		350	0.3	~50	710	4,250
		400	0.3	~50	670	4,000
Titanium alloy (Ti-6Al-4V)	DS150 (DS118) (JC8050)	~200	0.8	~50	300	960
		250	0.6	~50	300	960
		300	0.4	~50	280	900
		350	0.3	~50	280	900
		400	0.3	~50	250	800
Heat resistant alloy (INCO718)	JC8118 (DS118) (DS150)	~200	0.8	~50	150	350
		250	0.6	~50	150	350
		300	0.4	~50	130	310
		350	0.3	~50	130	310
		400	0.3	~50	100	240

Note

1. Please adjust cutting conditions according to machine rigidity or work rigidity.
2. In case of chatter occurring, recommended to reduce a_p or rpm and keep feed per tooth.
3. a_p should be reduced when using on low rigidity machine.
4. Use air blow.
5. When using ZPMT100320ZER-PL insert for High feed milling, reduce cutting conditions by 10-30%.

QM MAX

MQX/QXP Type

- Recommended cutting conditions
- MQX Type (EPHW insert) + MSN shank

2

Material	Grade	Tool dia.(mm)														
		16 / 17					20					20 / 21				
		2N					3N					4N				
		r (mm)	ap (mm)	ae (mm)	n (min ⁻¹)	Vf (mm/min)	r (mm)	ap (mm)	ae (mm)	n (min ⁻¹)	Vf (mm/min)	r (mm)	ap (mm)	ae (mm)	n (min ⁻¹)	Vf (mm/min)
Hardened die steel (SKD61, DAC, DHA) 42-52HRC	JC8118	~70	0.30	~10	1,790	2,860	~80	0.30	~14	1,430	3,430	~80	0.30	~14	1,430	4,570
		100	0.25	~10	1,610	2,060	120	0.25	~14	1,290	2,480	120	0.25	~14	1,290	3,300
		130	0.20	~10	1,430	1,370	160	0.20	~14	1,140	1,640	160	0.20	~14	1,140	2,190
Hardened die steel (SKD11, SLD, DC11) 55-62HRC	DH102	~70	0.20	~10	1,590	950	~80	0.20	~14	1,270	1,140	~80	0.20	~14	1,270	1,520
		100	0.15	~10	1,430	770	120	0.15	~14	1,140	920	120	0.15	~14	1,140	1,230
		130	0.10	~10	1,270	610	160	0.10	~14	1,020	730	160	0.10	~14	1,020	980

Material	Grade	Tool dia.(mm)									
		25 / 26					25 / 26 / 28				
		4N					5N				
		r (mm)	ap (mm)	ae (mm)	n (min ⁻¹)	Vf (mm/min)	r (mm)	ap (mm)	ae (mm)	n (min ⁻¹)	Vf (mm/min)
Hardened die steel (SKD61, DAC, DHA) 42-52HRC	JC8118	~100	0.30	~18	1,150	3,680	~100	0.30	~18	1,150	4,600
		150	0.25	~18	1,040	2,660	150	0.25	~18	1,040	3,330
		200	0.20	~18	920	1,770	200	0.20	~18	920	2,210
Hardened die steel (SKD11, SLD, DC11) 55-62HRC	DH102	~100	0.20	~18	1,020	1,220	~100	0.20	~18	1,020	1,530
		150	0.15	~18	920	990	150	0.15	~18	920	1,240
		200	0.10	~18	820	790	200	0.10	~18	820	980

Note

1. Please adjust cutting conditions according to machine rigidity or work rigidity.
2. In case of chatter occurring, recommended to reduce ap or rpm and keep feed per tooth.
3. ap should be reduced when using on low rigidity machine.
4. Use air blow.

QM MAX**MQX/QXP Type**

■ Recommended cutting conditions

● MQX Type (EPHW insert) + MSN shank

2

Material	Grade	Tool dia.(mm)									
		30 / 32 / 35					32 / 35				
		5N					6N				
		r (mm)	a _p (mm)	a _e (mm)	n (min ⁻¹)	V _f (mm/min)	r (mm)	a _p (mm)	a _e (mm)	n (min ⁻¹)	V _f (mm/min)
Hardened die steel (SKD61, DAC, DHA) 42-52HRC	JC8118	~130	0.30	~24	900	3,600	~130	0.30	~24	900	4,320
		190	0.25	~24	810	2,590	190	0.25	~24	810	3,110
		250	0.20	~24	720	1,730	250	0.20	~24	720	2,070
Hardened die steel (SKD11, SLD, DC11) 55-62HRC	DH102	~130	0.20	~24	800	1,200	~130	0.20	~24	800	1,440
		190	0.15	~24	720	970	190	0.15	~24	720	1,160
		250	0.10	~24	640	770	250	0.10	~24	640	920

Material	Grade	Tool dia.(mm)									
		40 / 42					40				
		6N					7N				
		r (mm)	a _p (mm)	a _e (mm)	n (min ⁻¹)	V _f (mm/min)	r (mm)	a _p (mm)	a _e (mm)	n (min ⁻¹)	V _f (mm/min)
Hardened die steel (SKD61, DAC, DHA) 42-52HRC	JC8118	~130	0.30	~32	720	3,460	~130	0.30	~32	720	4,030
		190	0.25	~32	650	2,500	190	0.25	~32	650	2,910
		250	0.20	~32	580	1,670	250	0.20	~32	580	1,950
Hardened die steel (SKD11, SLD, DC11) 55-62HRC	DH102	~130	0.20	~32	640	1,150	~130	0.20	~32	640	1,340
		190	0.15	~32	580	940	190	0.15	~32	580	1,100
		250	0.10	~32	510	740	250	0.10	~32	510	860

Note

1. Please adjust cutting conditions according to machine rigidity or work rigidity.
2. In case of chatter occurring, recommended to reduce a_p or rpm and keep feed per tooth.
3. a_p should be reduced when using on low rigidity machine.
4. Use air blow.

QM MAX
MQX/QXP Type
■ Recommended cutting conditions
● QXP Type (EPHW insert)
2

Material	Grade	Tool dia.(mm)									
		40									
		6N					7N				
		r (mm)	a_p (mm)	a_e (mm)	n (min ⁻¹)	V_f (mm/min)	r (mm)	a_p (mm)	a_e (mm)	n (min ⁻¹)	V_f (mm/min)
Hardened die steel (SKD61, DAC, DHA) 42-52HRC	JC8118	~100	0.30	~32	720	3,460	~100	0.30	~32	720	4,030
		150	0.25	~32	650	2,500	150	0.25	~32	650	2,910
		200	0.20	~32	580	1,670	200	0.20	~32	580	1,950
		250	0.10	~32	580	1,670	250	0.10	~32	580	1,950
Hardened die steel (SKD11, SLD, DC11) 55-62HRC	DH102	~100	0.20	~32	640	1,150	~100	0.20	~32	640	1,340
		150	0.15	~32	580	940	150	0.15	~32	580	1,100
		200	0.10	~32	510	740	200	0.10	~32	510	860
		250	-	-	-	-	250	-	-	-	-

Material	Grade	Tool dia.(mm)									
		50					50 / 52				
		7N					8N				
		r (mm)	a_p (mm)	a_e (mm)	n (min ⁻¹)	V_f (mm/min)	r (mm)	a_p (mm)	a_e (mm)	n (min ⁻¹)	V_f (mm/min)
Hardened die steel (SKD61, DAC, DHA) 42-52HRC	JC8118	~150	0.30	~40	570	3,190	~100	0.30	~40	570	3,650
		200	0.25	~40	510	2,280	150	0.25	~40	510	2,610
		250	0.20	~40	460	1,550	200	0.20	~40	460	1,770
		300	0.10	~40	460	1,550	250	0.10	~40	460	1,770
Hardened die steel (SKD11, SLD, DC11) 55-62HRC	DH102	~150	0.20	~40	510	1,070	~100	0.20	~40	510	1,220
		200	0.15	~40	460	870	150	0.15	~40	460	990
		250	0.10	~40	410	690	200	0.10	~40	410	790
		300	-	-	-	-	250	-	-	-	-
						300					

Material	Grade	Tool dia.(mm)									
		63 / 66									
		8N									
		r (mm)	a_p (mm)	a_e (mm)	n (min ⁻¹)	V_f (mm/min)					
Hardened die steel (SKD61, DAC, DHA) 42-52HRC	JC8118	~200	0.30	~50	450	2,880					
		250	0.25	~50	410	2,100					
		300	0.20	~50	360	1,380					
		350	0.10	~50	360	1,380					
Hardened die steel (SKD11, SLD, DC11) 55-62HRC	DH102	~200	0.20	~50	400	960					
		250	0.15	~50	360	780					
		300	0.10	~50	320	610					
		350	-	-	-	-					

Note

1. Please adjust cutting conditions according to machine rigidity or work rigidity.
2. In case of chatter occurring, recommended to reduce a_p or rpm and keep feed per tooth.
3. a_p should be reduced when using on low rigidity machine.
4. Use air blow.

QM MAX**MQX/QXP Type**

■ Recommended cutting conditions

● MQX Type (ZPMT-PL /NL/ SL insert)

3

Material	Chipbreaker	Grade	Tool dia. (mm)														
			16 / 17					20					20 / 21				
			2N					3N					4N				
			r (mm)	a _p (mm)	a _p ×a _e (mm ²)	n (min ⁻¹)	V _f (mm/min)	r (mm)	a _p (mm)	a _p ×a _e (mm ²)	n (min ⁻¹)	V _f (mm/min)	r (mm)	a _p (mm)	a _p ×a _e (mm ²)	n (min ⁻¹)	V _f (mm/min)
Carbon steel (S50C, S55C) below 250HB	PL	JC8050 (JC8118) (CX75)	~80	≤5.0	≤12.8	3,180	950	~100	≤5.0	≤16.0	2,550	1,150	~100	≤5.0	≤16.0	2,550	1,530
			120	≤3.0	≤6.4	2,860	770	150	≤3.0	≤8.0	2,300	930	150	≤3.0	≤8.0	2,300	1,240
			160	≤2.0	≤3.2	2,540	610	190	≤2.0	≤4.0	2,040	730	190	≤2.0	≤4.0	2,040	980
Tool & die steel (SKD61, SKD11) below 255HB	PL	JC8050 (JC8118)	~80	≤5.0	≤12.8	2,980	890	~100	≤5.0	≤16.0	2,390	1,080	~100	≤5.0	≤16.0	2,390	1,430
			120	≤3.0	≤6.4	2,680	720	150	≤3.0	≤8.0	2,150	870	150	≤3.0	≤8.0	2,150	1,160
			160	≤2.0	≤3.2	2,380	570	190	≤2.0	≤4.0	1,910	690	190	≤2.0	≤4.0	1,910	920
Mold steel (HPM7, PX5, P20) 30-36 HRC	PL	JC8118 (JC8050)	~80	≤5.0	≤12.8	2,980	890	~100	≤5.0	≤16.0	2,390	1,080	~100	≤5.0	≤16.0	2,390	1,430
			120	≤3.0	≤6.4	2,680	720	150	≤3.0	≤8.0	2,150	870	150	≤3.0	≤8.0	2,150	1,160
			160	≤2.0	≤3.2	2,380	570	190	≤2.0	≤4.0	1,910	690	190	≤2.0	≤4.0	1,910	920
Mold steel (NAK80, HPM1, P21) 38-43HRC	PL	JC8118 (JC8050)	~80	≤4.0	≤9.6	2,390	570	~100	≤4.0	≤12.0	1,910	690	~100	≤4.0	≤12.0	1,910	920
			120	≤2.5	≤4.8	2,150	470	150	≤2.5	≤6.0	1,720	570	150	≤2.5	≤6.0	1,720	760
			160	≤2.0	≤2.4	1,910	380	190	≤2.0	≤3.0	1,530	460	190	≤2.0	≤3.0	1,530	610
Hardened die steel (SKD61, DAC, DHA) 42-52HRC	PL	JC8118 (DH102)	~80	≤3.5	≤8.0	1,990	480	~100	≤3.5	≤10.0	1,590	570	~100	≤3.5	≤10.0	1,590	760
			120	≤2.5	≤4.0	1,790	390	150	≤2.5	≤5.0	1,430	460	150	≤2.5	≤5.0	1,430	620
			160	≤1.2	≤2.0	1,590	300	190	≤1.2	≤2.5	1,270	360	190	≤1.2	≤2.5	1,270	480
Hardened die steel (SKD11, SLD, DC11) 55-62HRC	PL	DH102	~80	≤2.5	≤6.4	1,390	280	~100	≤2.5	≤8.0	1,110	330	~100	≤2.5	≤8.0	1,110	440
			120	≤1.5	≤3.2	1,250	230	150	≤1.5	≤4.0	1,000	270	150	≤1.5	≤4.0	1,000	360
			160	-	-	-	-	190	-	-	-	-	190	-	-	-	-
Grey & Nodular cast iron (FC, FCD) below 300HB	PL	JC8118 (DH102)	~80	≤5.0	≤16.0	2,980	1,190	~100	≤5.0	≤20.0	2,390	1,430	~100	≤5.0	≤20.0	2,390	1,910
			120	≤4.0	≤8.0	2,680	960	150	≤4.0	≤10.0	2,150	1,160	150	≤4.0	≤10.0	2,150	1,550
			160	≤3.0	≤4.0	2,380	760	190	≤3.0	≤5.0	1,910	920	190	≤3.0	≤5.0	1,910	1,220
Stainless steel (SUS304) below 250HB	PL (SL)	JC8050 (JC8118) (JC7518)	~80	≤5.0	≤12.8	2,980	890	~100	≤5.0	≤16.0	2,390	1,080	~100	≤5.0	≤16.0	2,390	1,430
			120	≤3.0	≤6.4	2,680	720	150	≤3.0	≤8.0	2,150	870	150	≤3.0	≤8.0	2,150	1,160
			160	≤2.0	≤3.2	2,380	570	190	≤2.0	≤4.0	1,910	690	190	≤2.0	≤4.0	1,910	920
Titanium alloy (Ti-6Al-4V)	SL	DS118 (JC7518)	~80	≤5.0	≤9.6	1,190	360	~100	≤5.0	≤12.0	950	430	~100	≤5.0	≤12.0	950	570
			120	≤3.0	≤4.8	1,070	290	150	≤3.0	≤6.0	860	350	150	≤3.0	≤6.0	860	460
			160	≤2.0	≤2.4	950	230	190	≤2.0	≤3.0	760	270	190	≤2.0	≤3.0	760	360
Heat resistant alloy (INCO718)	SL	DS118 (JC7518)	~80	≤5.0	≤9.6	600	180	~100	≤5.0	≤12.0	480	220	~100	≤5.0	≤12.0	480	290
			120	≤3.0	≤4.8	540	140	150	≤3.0	≤6.0	430	170	150	≤3.0	≤6.0	430	230
			160	≤2.0	≤2.4	480	110	190	≤2.0	≤3.0	380	140	190	≤2.0	≤3.0	380	180
Aluminium alloy below 50-110HB	NL	FC18	~80	≤5.0	≤32.0	12,000	4,800	~100	≤5.0	≤40.0	9,550	5,730	~100	≤5.0	≤40.0	9,550	7,640
			120	≤4.0	≤16.0	9,000	3,240	150	≤4.0	≤20.0	7,160	3,870	150	≤4.0	≤20.0	7,160	5,160
			160	≤3.0	≤8.0	6,000	1,920	190	≤3.0	≤10.0	4,780	2,290	190	≤3.0	≤10.0	4,780	3,060

Note

1. Please adjust cutting conditions according to machine rigidity or work rigidity.
2. In case of chatter occurring, recommended to reduce a_p or rpm and keep feed per tooth.
3. a_p should be reduced when using on low rigidity machine.
4. Use air blow.
5. Please scan QR code below for cutting conditions when using ZPMT-PL/NL/SL for side & bottom finishing.



QM MAX **MQX/QXP Type**

- Recommended cutting conditions
- MQX Type (ZPMT-PL /NL/ SL insert)

3

Material	Chipbreaker	Grade	Tool dia.(mm)									
			25 / 26					25 / 26 / 28				
			4N					5N				
			r (mm)	ap (mm)	ap×ae (mm ²)	n (min ⁻¹)	Vf (mm/min)	r (mm)	ap (mm)	ap×ae (mm ²)	n (min ⁻¹)	Vf (mm/min)
Carbon steel (S50C, S55C) below 250HB	PL	JC8050 (JC8118) (CX75)	~120	≤5.0	≤20.0	2,040	1,220	~120	≤5.0	≤20.0	2,040	1,530
			190	≤3.0	≤10.0	1,840	990	190	≤3.0	≤10.0	1,840	1,240
			235	≤2.0	≤5.0	1,630	780	235	≤2.0	≤5.0	1,630	980
Tool & die steel (SKD61, SKD11) below 255HB	PL	JC8050 (JC8118)	~120	≤5.0	≤20.0	1,910	1,150	~120	≤5.0	≤20.0	1,910	1,430
			190	≤3.0	≤10.0	1,720	930	190	≤3.0	≤10.0	1,720	1,160
			235	≤2.0	≤5.0	1,530	730	235	≤2.0	≤5.0	1,530	920
Mold steel (HPM7, PX5, P20) 30-36 HRC	PL	JC8118 (JC8050)	~120	≤5.0	≤20.0	1,910	1,150	~120	≤5.0	≤20.0	1,910	1,430
			190	≤3.0	≤10.0	1,720	930	190	≤3.0	≤10.0	1,720	1,160
			235	≤2.0	≤5.0	1,530	730	235	≤2.0	≤5.0	1,530	920
Mold steel (NAK80, HPM1, P21) 38-43HRC	PL	JC8118 (JC8050)	~120	≤4.0	≤15.0	1,530	740	~120	≤4.0	≤15.0	1,530	920
			190	≤2.5	≤7.5	1,380	610	190	≤2.5	≤7.5	1,380	760
			235	≤1.5	≤3.8	1,220	490	235	≤1.5	≤3.8	1,220	610
Hardened die steel (SKD61, DAC, DHA) 42-52HRC	PL	JC8118 (DH102)	~120	≤3.5	≤12.5	1,270	610	~120	≤3.5	≤12.5	1,270	760
			190	≤2.5	≤6.2	1,140	490	190	≤2.5	≤6.2	1,140	620
			235	≤1.2	≤3.2	1,020	390	235	≤1.2	≤3.2	1,020	490
Hardened die steel (SKD11, SLD, DC11) 55-62HRC	PL	DH102	~120	≤2.5	≤10.0	890	360	~120	≤2.5	≤10.0	890	440
			190	≤1.5	≤5.0	800	290	190	≤1.5	≤5.0	800	360
			235	-	-	-	-	235	-	-	-	-
Grey & Nodular Cast iron (FC, FCD) below 300HB	PL	JC8118 (DH102)	~120	≤5.0	≤25.0	1,910	1,530	~120	≤5.0	≤25.0	1,910	1,910
			190	≤4.0	≤12.5	1,720	1,240	190	≤4.0	≤12.5	1,720	1,550
			235	≤3.0	≤6.2	1,530	980	235	≤3.0	≤6.2	1,530	1,220
Stainless steel (SUS304) below 250HB	PL (SL)	JC8050 (JC8118) (JC7518)	~120	≤5.0	≤20.0	1,910	1,150	~120	≤5.0	≤20.0	1,910	1,430
			190	≤3.0	≤10.0	1,720	930	190	≤3.0	≤10.0	1,720	1,160
			235	≤2.0	≤5.0	1,530	730	235	≤2.0	≤5.0	1,530	920
Titanium alloy (Ti-6Al-4V)	SL	DS118 (JC7518)	~120	≤5.0	≤15.0	760	460	~120	≤5.0	≤15.0	760	570
			190	≤3.0	≤7.5	680	370	190	≤3.0	≤7.5	680	460
			235	≤2.0	≤3.8	610	290	235	≤2.0	≤3.8	610	370
Heat resistant alloy (INCO718)	SL	DS118 (JC7518)	~120	≤5.0	≤15.0	380	230	~120	≤5.0	≤15.0	380	280
			190	≤3.0	≤7.5	340	180	190	≤3.0	≤7.5	340	230
			235	≤2.0	≤3.8	300	140	235	≤2.0	≤3.8	300	180
Aluminium alloy below 50-110HB	NL	FC18	~120	≤5.0	≤50.0	7,640	6,110	~120	≤5.0	≤50.0	7,640	7,640
			190	≤4.0	≤25.0	5,730	4,120	190	≤4.0	≤25.0	5,730	5,160
			235	≤3.0	≤12.5	3,820	2,440	235	≤3.0	≤12.5	3,820	3,060

Note

1. Please adjust cutting conditions according to machine rigidity or work rigidity.
2. In case of chatter occurring, recommended to reduce ap or rpm and keep feed per tooth.
3. ap should be reduced when using on low rigidity machine.
4. Use air blow.
5. Please scan QR code below for cutting conditions when using ZPMT-PL/NL/SL for side & bottom finishing.



QM MAX**MQX/QXP Type**

■ Recommended cutting conditions

● MQX Type (ZPMT-PL /NL/ SL insert)

3

Material	Chipbreaker	Grade	Tool dia.(mm)									
			30 / 32 / 35					32 / 35				
			5N					6N				
			r (mm)	a _p (mm)	a _p ×a _e (mm ²)	n (min ⁻¹)	V _f (mm/min)	r (mm)	a _p (mm)	a _p ×a _e (mm ²)	n (min ⁻¹)	V _f (mm/min)
Carbon steel (S50C, S55C) below 250HB	PL	JC8050 (JC8118) (CX75)	~160	≦5.0	≦24.0	1,590	1,190	~160	≦5.0	≦24.0	1,590	1,430
			240	≦3.0	≦12.0	1,430	960	240	≦3.0	≦12.0	1,430	1,160
			290	≦2.0	≦6.0	1,270	760	290	≦2.0	≦6.0	1,270	910
Tool & die steel (SKD61, SKD11) below 255HB	PL	JC8050 (JC8118)	~160	≦5.0	≦24.0	1,490	1,120	~160	≦5.0	≦24.0	1,490	1,340
			240	≦3.0	≦12.0	1,340	900	240	≦3.0	≦12.0	1,340	1,080
			290	≦2.0	≦6.0	1,190	710	290	≦2.0	≦6.0	1,190	860
Mold steel (HPM7, PX5, P20) 30-36 HRC	PL	JC8118 (JC8050)	~160	≦5.0	≦24.0	1,490	1,120	~160	≦5.0	≦24.0	1,490	1,340
			240	≦3.0	≦12.0	1,340	900	240	≦3.0	≦12.0	1,340	1,080
			290	≦2.0	≦6.0	1,190	710	290	≦2.0	≦6.0	1,190	860
Mold steel (NAK80, HPM1, P21) 38-43HRC	PL	JC8118 (JC8050)	~160	≦4.0	≦18.0	1,200	720	~160	≦4.0	≦18.0	1,200	860
			240	≦2.5	≦9.0	1,080	600	240	≦2.5	≦9.0	1,080	710
			290	≦2.0	≦4.5	960	480	290	≦2.0	≦4.5	960	580
Hardened die steel (SKD61, DAC, DHA) 42-52HRC	PL	JC8118 (DH102)	~160	≦3.5	≦15.0	1,000	600	~160	≦3.5	≦15.0	1,000	720
			240	≦2.5	≦7.5	900	490	240	≦2.5	≦7.5	900	580
			290	≦1.2	≦3.8	800	380	290	≦2.0	≦3.8	800	460
Hardened die steel (SKD11, SLD, DC11) 55-62HRC	PL	DH102	~160	≦2.5	≦12.0	700	350	~160	≦2.5	≦12.0	700	420
			240	≦1.5	≦6.0	630	280	240	≦1.5	≦6.0	630	340
			290	-	-	-	-	290	-	-	-	-
Grey & Nodular Cast iron (FC, FCD) below 300HB	PL	JC8118 (DH102)	~160	≦5.0	≦30.0	1,490	1,490	~160	≦5.0	≦30.0	1,490	1,790
			240	≦4.0	≦15.0	1,340	1,210	240	≦4.0	≦15.0	1,340	1,450
			290	≦3.0	≦7.5	1,190	950	290	≦3.0	≦7.5	1,190	1,140
Stainless steel (SUS304) below 250HB	PL (SL)	JC8050 (JC8118) (JC7518)	~160	≦5.0	≦24.0	1,490	1,120	~160	≦5.0	≦24.0	1,490	1,340
			240	≦3.0	≦12.0	1,340	900	240	≦3.0	≦12.0	1,340	1,080
			290	≦2.0	≦6.0	1,190	710	290	≦2.0	≦6.0	1,190	860
Titanium alloy (Ti-6Al-4V)	SL	DS118 (JC7518)	~160	≦5.0	≦18.0	600	450	~160	≦5.0	≦18.0	600	540
			240	≦3.0	≦9.0	540	360	240	≦3.0	≦9.0	540	440
			290	≦2.0	≦4.5	480	290	290	≦2.0	≦4.5	480	340
Heat resistant alloy (INCO718)	SL	DS118 (JC7518)	~160	≦5.0	≦18.0	300	230	~160	≦5.0	≦18.0	300	270
			240	≦3.0	≦9.0	270	180	240	≦3.0	≦9.0	270	220
			290	≦2.0	≦4.5	240	140	290	≦2.0	≦4.5	240	170
Aluminium alloy below 50-110HB	NL	FC18	~160	≦5.0	≦64.0	5,970	5,970	~160	≦5.0	≦64.0	5,970	7,160
			240	≦4.0	≦32.0	4,480	4,030	240	≦4.0	≦32.0	4,480	4,840
			290	≦3.0	≦16.0	2,990	2,390	290	≦3.0	≦16.0	2,990	2,870

Note

1. Please adjust cutting conditions according to machine rigidity or work rigidity.
2. In case of chatter occurring, recommended to reduce a_p or rpm and keep feed per tooth.
3. a_p should be reduced when using on low rigidity machine.
4. Use air blow.
5. Please scan QR code below for cutting conditions when using ZPMT-PL/NL/SL for side & bottom finishing.



QM MAX **MQX/QXP Type**

- Recommended cutting conditions
- MQX Type (ZPMT-PL /NL/ SL insert)

3

Material	Chipbreaker	Grade	Tool dia.(mm)									
			40 / 42					40				
			6N					7N				
			r (mm)	ap (mm)	ap×ae (mm ²)	n (min ⁻¹)	Vf (mm/min)	r (mm)	ap (mm)	ap×ae (mm ²)	n (min ⁻¹)	Vf (mm/min)
Carbon steel (S50C, S55C) below 250HB	PL	JC8050 (JC8118) (CX75)	~160	≤5.0	≤32.0	1,270	1,140	~160	≤5.0	≤32.0	1,270	1,330
			240	≤3.0	≤16.0	1,140	920	240	≤3.0	≤16.0	1,140	1,080
			290	≤2.0	≤8.0	1,020	730	290	≤2.0	≤8.0	1,020	860
Tool & die steel (SKD61, SKD11) below 255HB	PL	JC8050 (JC8118)	~160	≤5.0	≤32.0	1,190	1,070	~160	≤5.0	≤32.0	1,190	1,250
			240	≤3.0	≤16.0	1,070	870	240	≤3.0	≤16.0	1,070	1,010
			290	≤2.0	≤8.0	950	680	290	≤2.0	≤8.0	950	800
Mold steel (HPM7, PX5, P20) 30-36 HRC	PL	JC8118 (JC8050)	~160	≤5.0	≤32.0	1,190	1,070	~160	≤5.0	≤32.0	1,190	1,250
			240	≤3.0	≤16.0	1,070	870	240	≤3.0	≤16.0	1,070	1,010
			290	≤2.0	≤8.0	950	680	290	≤2.0	≤8.0	950	800
Mold steel (NAK80, HPM1, P21) 38-43HRC	PL	JC8118 (JC8050)	~160	≤4.0	≤24.0	950	680	~160	≤4.0	≤24.0	950	800
			240	≤2.5	≤12.0	860	570	240	≤2.5	≤12.0	860	660
			290	≤2.0	≤6.0	760	460	290	≤2.0	≤6.0	760	530
Hardened die steel (SKD61, DAC, DHA) 42-52HRC	PL	JC8118 (DH102)	~160	≤3.5	≤20.0	800	580	~160	≤3.5	≤20.0	800	670
			240	≤2.5	≤10.0	720	470	240	≤2.5	≤10.0	720	540
			290	≤1.2	≤5.0	640	370	290	≤1.2	≤5.0	640	430
Hardened die steel (SKD11, SLD, DC11) 55-62HRC	PL	DH102	~160	≤2.5	≤16.0	560	340	~160	≤2.5	≤16.0	560	390
			240	≤1.5	≤8.0	500	270	240	≤1.5	≤8.0	500	310
			290	-	-	-	-	290	-	-	-	-
Grey & Nodular cast iron (FC, FCD) below 300HB	PL	JC8118 (DH102)	~160	≤5.0	≤40.0	1,190	1,430	~160	≤5.0	≤40.0	1,190	1,670
			240	≤4.0	≤20.0	1,070	1,160	240	≤4.0	≤20.0	1,070	1,350
			290	≤3.0	≤10.0	950	910	290	≤3.0	≤10.0	950	1,060
Stainless steel (SUS304) below 250HB	PL (SL)	JC8050 (JC8118) (JC7518)	~160	≤5.0	≤32.0	1,190	1,070	~160	≤5.0	≤32.0	1,190	1,250
			240	≤3.0	≤16.0	1,070	870	240	≤3.0	≤16.0	1,070	1,010
			290	≤2.0	≤8.0	950	680	290	≤2.0	≤8.0	950	800
Titanium alloy (Ti-6Al-4V)	SL	DS118 (JC7518)	~160	≤5.0	≤24.0	480	430	~160	≤5.0	≤24.0	480	500
			240	≤3.0	≤12.0	430	350	240	≤3.0	≤12.0	430	410
			290	≤2.0	≤6.0	380	270	290	≤2.0	≤6.0	380	320
Heat resistant alloy (INCO718)	SL	DS118 (JC7518)	~160	≤5.0	≤24.0	240	220	~160	≤5.0	≤24.0	240	250
			240	≤3.0	≤12.0	220	180	240	≤3.0	≤12.0	220	210
			290	≤2.0	≤6.0	190	140	290	≤2.0	≤6.0	190	160
Aluminium alloy below 50-110HB	NL	FC18	~160	≤5.0	≤80.0	4,780	5,740	~160	≤5.0	≤80.0	4,780	6,690
			240	≤4.0	≤40.0	3,580	3,870	240	≤4.0	≤40.0	3,580	4,510
			290	≤3.0	≤20.0	2,390	2,290	290	≤3.0	≤20.0	2,390	2,680

Note

1. Please adjust cutting conditions according to machine rigidity or work rigidity.
2. In case of chatter occurring, recommended to reduce ap or rpm and keep feed per tooth.
3. ap should be reduced when using on low rigidity machine.
4. Use air blow.
5. Please scan QR code below for cutting conditions when using ZPMT-PL/NL/SL for side & bottom finishing.



QM MAX**MQX/QXP Type**

- Recommended cutting conditions
- QXP Type (ZPMT-PL /NL/ SL insert)

3

Material	Chipbreaker	Grade	Tool dia.(mm)									
			40									
			6N					7N				
			r (mm)	a _p (mm)	a _p ×a _e (mm ²)	n (min ⁻¹)	V _f (mm/min)	r (mm)	a _p (mm)	a _p ×a _e (mm ²)	n (min ⁻¹)	V _f (mm/min)
Carbon steel (S50C, S55C) below 250HB	PL	JC8050 (JC8118) (CX75)	~150	≦5.0	≦32.0	1,270	1,140	~150	≦5.0	≦32.0	1,270	1,330
			200	≦3.0	≦16.0	1,140	920	200	≦3.0	≦16.0	1,140	1,080
			250	≦2.0	≦8.0	1,020	730	250	≦2.0	≦8.0	1,020	860
Tool & die steel (SKD61, SKD11) below 255HB	PL	JC8050 (JC8118)	~150	≦5.0	≦32.0	1,190	1,070	~150	≦5.0	≦32.0	1,190	1,250
			200	≦3.0	≦16.0	1,070	870	200	≦3.0	≦16.0	1,070	1,010
			250	≦2.0	≦8.0	950	680	250	≦2.0	≦8.0	950	800
Mold steel (HPM7, PX5, P20) 30-36 HRC	PL	JC8118 (JC8050)	~150	≦5.0	≦32.0	1,190	1,070	~150	≦5.0	≦32.0	1,190	1,250
			200	≦3.0	≦16.0	1,070	870	200	≦3.0	≦16.0	1,070	1,010
			250	≦2.0	≦8.0	950	680	250	≦2.0	≦8.0	950	800
Mold steel (NAK80, HPM1, P21) 38-43HRC	PL	JC8118 (JC8050)	~150	≦4.0	≦24.0	950	680	~150	≦4.0	≦24.0	950	800
			200	≦2.5	≦12.0	860	570	200	≦2.5	≦12.0	860	660
			250	≦2.0	≦6.0	760	460	250	≦2.0	≦6.0	760	530
Hardened die steel (SKD61, DAC, DHA) 42-52HRC	PL	JC8118 (DH102)	~150	≦3.5	≦20.0	800	580	~150	≦3.5	≦20.0	800	670
			200	≦2.5	≦10.0	720	470	200	≦2.5	≦10.0	720	540
			250	≦1.2	≦5.0	640	370	250	≦1.2	≦5.0	640	430
Hardened die steel (SKD11, SLD, DC11) 55-62HRC	PL	DH102	~150	≦2.5	≦16.0	560	340	~150	≦2.5	≦16.0	560	390
			200	≦1.5	≦8.0	500	270	200	≦1.5	≦8.0	500	310
			250	-	-	-	-	250	-	-	-	-
Grey & Nodular cast iron (FC, FCD) below 300HB	PL	JC8118 (DH102)	~150	≦5.0	≦40.0	1,190	1,430	~150	≦5.0	≦40.0	1,190	1,670
			200	≦4.0	≦20.0	1,070	1,160	200	≦4.0	≦20.0	1,070	1,350
			250	≦3.0	≦10.0	950	910	250	≦3.0	≦10.0	950	1,060
Stainless steel (SUS304) below 250HB	PL (SL)	JC8050 (JC8118) (JC7518)	~150	≦5.0	≦32.0	1,190	1,070	~150	≦5.0	≦32.0	1,190	1,250
			200	≦3.0	≦16.0	1,070	870	200	≦3.0	≦16.0	1,070	1,010
			250	≦2.0	≦8.0	950	680	250	≦2.0	≦8.0	950	800
Titanium alloy (Ti-6Al-4V)	SL	DS118 (JC7518)	~150	≦5.0	≦24.0	480	430	~150	≦5.0	≦24.0	480	500
			200	≦3.0	≦12.0	430	350	200	≦3.0	≦12.0	430	410
			250	≦2.0	≦6.0	380	270	250	≦2.0	≦6.0	380	320
Heat resistant alloy (INCO718)	SL	DS118 (JC7518)	~150	≦5.0	≦24.0	240	220	~150	≦5.0	≦24.0	240	250
			200	≦3.0	≦12.0	220	180	200	≦3.0	≦12.0	220	210
			250	≦2.0	≦6.0	190	140	250	≦2.0	≦6.0	190	160
Aluminium alloy below 50-110HB	NL	FC18	~150	≦5.0	≦80.0	4,780	5,740	~150	≦5.0	≦80.0	4,780	6,690
			200	≦4.0	≦40.0	3,580	3,870	200	≦4.0	≦40.0	3,580	4,510
			250	≦3.0	≦20.0	2,390	2,290	250	≦3.0	≦20.0	2,390	2,680

Note

1. Please adjust cutting conditions according to machine rigidity or work rigidity.
2. In case of chatter occurring, recommended to reduce a_p or rpm and keep feed per tooth.
3. a_p should be reduced when using on low rigidity machine.
4. Use air blow.
5. Please scan QR code below for cutting conditions when using ZPMT-PL/NL/SL for side & bottom finishing.



QM MAX **MQX/QXP Type**

- Recommended cutting conditions
- QXP Type (ZPMT-PL /NL/ SL insert)

3

Material	Chipbreaker	Grade	Tool dia.(mm)									
			50					50 / 52				
			7N					8N				
			r (mm)	ap (mm)	ap×ae (mm ²)	n (min ⁻¹)	Vf (mm/min)	r (mm)	ap (mm)	ap×ae (mm ²)	n (min ⁻¹)	Vf (mm/min)
Carbon steel (S50C, S55C) below 250HB	PL	JC8050 (JC8118) (CX75)	~200	≦5.0	≦40.0	1,020	1,070	~200	≦5.0	≦40.0	1,020	1,220
			250	≦3.0	≦20.0	920	870	250	≦3.0	≦20.0	920	990
			300	≦2.0	≦10.0	820	690	300	≦2.0	≦10.0	820	790
Tool & die steel (SKD61, SKD11) below 255HB	PL	JC8050 (JC8118)	~200	≦5.0	≦40.0	950	1,000	~200	≦5.0	≦40.0	950	1,140
			250	≦3.0	≦20.0	860	810	250	≦3.0	≦20.0	860	930
			300	≦2.0	≦10.0	760	640	300	≦2.0	≦10.0	760	730
Mold steel (HPM7, PX5, P20) 30-36 HRC	PL	JC8118 (JC8050)	~200	≦5.0	≦40.0	950	1,000	~200	≦5.0	≦40.0	950	1,140
			250	≦3.0	≦20.0	860	810	250	≦3.0	≦20.0	860	930
			300	≦2.0	≦10.0	760	640	300	≦2.0	≦10.0	760	730
Mold steel (NAK80, HPM1, P21) 38-43HRC	PL	JC8118 (JC8050)	~200	≦4.0	≦30.0	760	640	~200	≦4.0	≦30.0	760	730
			250	≦2.5	≦15.0	680	520	250	≦2.5	≦15.0	680	600
			300	≦2.0	≦7.5	610	430	300	≦2.0	≦7.5	610	490
Hardened die steel (SKD61, DAC, DHA) 42-52HRC	PL	JC8118 (DH102)	~200	≦3.5	≦25.0	640	540	~200	≦3.5	≦25.0	640	610
			250	≦2.0	≦12.5	580	440	250	≦2.0	≦12.5	580	500
			300	≦1.2	≦6.0	510	340	300	≦1.2	≦6.0	510	390
Hardened die steel (SKD11, SLD, DC11) 55-62HRC	PL	DH102	~200	≦2.5	≦20.0	450	320	~200	≦2.5	≦20.0	450	360
			250	≦1.5	≦10.0	400	250	250	≦1.5	≦10.0	400	290
			300	≦1.0	≦5.0	360	200	300	≦1.0	≦5.0	360	230
Gery & Nodular cast iron (FC, FCD) below 300HB	PL	JC8118 (DH102)	~200	≦5.0	≦50.0	950	1,330	~200	≦5.0	≦50.0	950	1,520
			250	≦4.0	≦25.0	860	1,080	250	≦4.0	≦25.0	860	1,240
			300	≦3.0	≦12.5	760	850	300	≦3.0	≦12.5	760	970
Stainless steel (SUS304) below 250HB	PL (SL)	JC8050 (JC8118) (JC7518)	~200	≦5.0	≦40.0	950	1,000	~200	≦5.0	≦40.0	950	1,140
			250	≦3.0	≦20.0	860	810	250	≦3.0	≦20.0	860	930
			300	≦2.0	≦10.0	760	640	300	≦2.0	≦10.0	760	730
Titanium alloy (Ti-6Al-4V)	SL	DS118 (JC7518)	~200	≦5.0	≦30.0	380	400	~200	≦5.0	≦30.0	380	460
			250	≦3.0	≦15.0	340	320	250	≦3.0	≦15.0	340	370
			300	≦2.0	≦7.5	300	250	300	≦2.0	≦7.5	300	290
Heat resistant alloy (INCO718)	SL	DS118 (JC7518)	~200	≦5.0	≦30.0	190	200	~200	≦5.0	≦30.0	190	230
			250	≦3.0	≦15.0	170	160	250	≦3.0	≦15.0	170	180
			300	≦2.0	≦7.5	150	130	300	≦2.0	≦7.5	150	140
Aluminium alloy below 50-110HB	NL	FC18	~200	≦5.0	≦100.0	3,820	5,350	~200	≦5.0	≦100.0	3,820	6,110
			250	≦4.0	≦50.0	2,860	3,600	250	≦4.0	≦50.0	2,860	4,120
			300	≦3.0	≦25.0	1,910	2,140	300	≦3.0	≦25.0	1,910	2,440

Note

1. Please adjust cutting conditions according to machine rigidity or work rigidity.
2. In case of chatter occurring, recommended to reduce ap or rpm and keep feed per tooth.
3. ap should be reduced when using on low rigidity machine.
4. Use air blow.
5. Please scan QR code below for cutting conditions when using ZPMT-PL/NL/SL for side & bottom finishing.



QM MAX**MQX/QXP Type**

- Recommended cutting conditions
- QXP Type (ZPMT-PL /NL/ SL insert)

3

Material	Chipbreaker	Grade	Tool dia.(mm)						
			63/66						
			8N						
			r (mm)	ap (mm)	ap×ae (mm ²)	n (min ⁻¹)	Vf (mm/min)		
Carbon steel (S50C, S55C) below 250HB	PL	JC8050 (JC8118) (CX75)	~250	≤5.0	≤50.0	810	970		
			300	≤3.0	≤25.0	730	790		
			350	≤2.0	≤12.5	650	620		
Tool & die steel (SKD61, SKD11) below 255HB	PL	JC8050 (JC8118)	~250	≤5.0	≤50.0	760	910		
			300	≤3.0	≤25.0	680	730		
			350	≤2.0	≤12.5	610	580		
Mold steel (HPM7, PX5, P20) 30-36 HRC	PL	JC8118 (JC8050)	~250	≤5.0	≤50.0	760	910		
			300	≤3.0	≤25.0	680	730		
			350	≤2.0	≤12.5	610	580		
Mold steel (NAK80, HPM1, P21) 38-43HRC	PL	JC8118 (JC8050)	~250	≤4.0	≤38.0	610	590		
			300	≤2.5	≤19.0	550	480		
			350	≤2.0	≤9.5	490	390		
Hardened die steel (SKD61, DAC, DHA) 42-52HRC	PL	JC8118 (DH102)	~250	≤3.5	≤32.0	500	480		
			300	≤2.5	≤16.0	450	390		
			350	≤1.5	≤7.5	400	310		
Hardened die steel (SKD11, SLD, DC11) 55-62HRC	PL	DH102	~250	≤2.5	≤25.0	350	280		
			300	≤1.5	≤12.5	320	230		
			350	≤1.0	≤6.5	280	180		
Grey & Nodular cast iron (FC, FCD) below 300HB	PL	JC8118 (DH102)	~250	≤5.0	≤64.0	760	1,220		
			300	≤4.0	≤32.0	680	980		
			350	≤3.0	≤16.0	610	780		
Stainless steel (SUS304) below 250HB	PL (SL)	JC8050 (JC8118) (JC7518)	~250	≤5.0	≤50.0	760	910		
			300	≤3.0	≤25.0	680	730		
			350	≤2.0	≤12.5	610	580		
Titanium alloy (Ti-6Al-4V)	SL	DS118 (JC7518)	~250	≤5.0	≤38.0	300	360		
			300	≤3.0	≤19.0	270	290		
			350	≤2.0	≤9.5	240	230		
Heat resistant alloy (INCO718)	SL	DS118 (JC7518)	~250	≤5.0	≤38.0	150	180		
			300	≤3.0	≤19.0	140	150		
			350	≤2.0	≤9.5	120	110		
Aluminium alloy below 50-110HB	NL	FC18	~250	≤5.0	≤128.0	3,030	4,850		
			300	≤4.0	≤63.0	2,270	3,270		
			350	≤3.0	≤31.5	1,520	1,940		

Note

1. Please adjust cutting conditions according to machine rigidity or work rigidity.
2. In case of chatter occurring, recommended to reduce ap or rpm and keep feed per tooth.
3. ap should be reduced when using on low rigidity machine.
4. Use air blow.
5. Please scan QR code below for cutting conditions when using ZPMT-PL/NL/SL for side & bottom finishing.



QM MAX

MQX/QXP Type

■ Recommended cutting conditions

● MQX Type (YPHW-15 /-F insert) - Vertical side finishing (UP&DOWN milling)

4

Material	Grade	Tool dia.(mm)														
		16/17					20					20/21				
		2N					3N					4N				
		ℓ (mm)	Pr (mm)	ae (mm)	n (min ⁻¹)	Vf (mm/min)	ℓ (mm)	Pr (mm)	ae (mm)	n (min ⁻¹)	Vf (mm/min)	ℓ (mm)	Pr (mm)	ae (mm)	n (min ⁻¹)	Vf (mm/min)
Carbon steel (S50C, S55C) below 250HB	JC8015 (DH102)	~70	0.5	<0.2	8,950	2,680	~70	0.6	<0.2	7,160	3,220	~70	0.6	<0.2	7,160	4,290
		120	0.5	<0.2	6,960	1,390	120	0.6	<0.2	7,160	2,790	120	0.6	<0.2	7,160	3,720
		160	0.5	<0.2	6,960	1,110	190	0.6	<0.2	5,570	1,670	190	0.6	<0.2	5,570	2,230
Tool & die steel (SKD61, SKD11) below 255HB	JC8015 (DH102)	~70	0.5	<0.2	7,960	2,390	~70	0.6	<0.2	6,370	3,220	~70	0.6	<0.2	6,370	4,290
		120	0.5	<0.2	5,970	1,190	120	0.6	<0.2	6,370	2,480	120	0.6	<0.2	6,370	3,310
		160	0.5	<0.2	5,970	960	190	0.6	<0.2	4,770	1,430	190	0.6	<0.2	4,770	1,910
Mold steel (HPM7, PX5, P20) 30-36 HRC	JC8015 (DH102)	~70	0.5	<0.2	6,960	1,670	~70	0.6	<0.2	5,570	2,000	~70	0.6	<0.2	5,570	2,670
		120	0.5	<0.2	4,970	840	120	0.6	<0.2	5,570	1,670	120	0.6	<0.2	5,570	2,230
		160	0.5	<0.2	4,970	700	190	0.6	<0.2	3,980	960	190	0.6	<0.2	3,980	1,280
Mold steel (NAK80, HPM1, P21) 38-43HRC	JC8015 (DH102)	~70	0.5	<0.2	4,980	1,200	~70	0.6	<0.2	3,980	1,430	~70	0.6	<0.2	3,980	1,910
		120	0.5	<0.2	3,560	600	120	0.6	<0.2	3,980	1,190	120	0.6	<0.2	3,980	1,590
		160	0.5	<0.2	3,560	500	190	0.6	<0.2	2,840	690	190	0.6	<0.2	2,840	920
Hardened die steel (SKD61, DAC, DHA) 42-52HRC	DH102 (JC8015)	~70	0.5	<0.15	3,380	680	~70	0.6	<0.15	2,710	810	~70	0.6	<0.15	2,710	1,080
		120	0.5	<0.15	2,400	340	120	0.6	<0.15	2,710	670	120	0.6	<0.15	2,710	890
		160	0.5	<0.15	2,400	280	190	0.6	<0.15	1,940	390	190	0.6	<0.15	1,940	520
Grey & Nodular cast iron (FC, FCD) below 300HB	JC8015 (DH102)	~70	0.5	<0.2	10,900	3,270	~70	0.6	<0.2	8,750	3,940	~70	0.6	<0.2	8,750	5,250
		120	0.5	<0.2	8,950	2,150	120	0.6	<0.2	7,160	2,580	120	0.6	<0.2	7,160	3,440
		160	0.5	<0.2	8,950	1,790	190	0.6	<0.2	7,160	2,150	190	0.6	<0.2	7,160	2,870

Note

1. Please adjust cutting conditions according to machine rigidity or work rigidity.
2. In case of chatter occurring, recommended to reduce ap or rpm and keep feed per tooth.
3. ap should be reduced when using on low rigidity machine.
4. Use air blow.

QM MAX**MQX/QXP Type**

■ Recommended cutting conditions

● MQX Type (YPHW-15 /-F insert) - Vertical side finishing (UP&DOWN milling)

4

Material	Grade	Tool dia.(mm)														
		25/26					25/26/28					30/32/35				
		4N					5N					5N				
		ℓ (mm)	Pf (mm)	ae (mm)	n (min ⁻¹)	Vf (mm/min)	ℓ (mm)	Pf (mm)	ae (mm)	n (min ⁻¹)	Vf (mm/min)	ℓ (mm)	Pf (mm)	ae (mm)	n (min ⁻¹)	Vf (mm/min)
Carbon steel (S50C, S55C) below 250HB	JC8015 (DH102)	~90	0.7	<0.2	5,730	4,120	~90	0.7	<0.2	5,730	6,210	~100	0.8	<0.2	4,480	4,030
		140	0.7	<0.2	5,730	3,440	140	0.7	<0.2	5,730	4,300	150	0.8	<0.2	4,480	4,030
		210	0.7	<0.2	4,460	2,140	210	0.7	<0.2	4,460	2,680	210	0.8	<0.2	3,480	2,610
Tool & die steel (SKD61, SKD11) below 255HB	JC8015 (DH102)	~90	0.7	<0.2	5,090	3,660	~90	0.7	<0.2	5,090	4,580	~100	0.8	<0.2	3,980	3,580
		140	0.7	<0.2	5,090	3,050	140	0.7	<0.2	5,090	3,810	150	0.8	<0.2	3,980	3,580
		210	0.7	<0.2	3,820	1,830	210	0.7	<0.2	3,820	2,290	210	0.8	<0.2	2,980	1,740
Mold steel (HPM7, PX5, P20) 30-36 HRC	JC8015 (DH102)	~90	0.7	<0.2	4,460	2,680	~90	0.7	<0.2	4,460	3,350	~100	0.8	<0.2	3,480	2,610
		140	0.7	<0.2	4,460	2,140	140	0.7	<0.2	4,460	2,680	150	0.8	<0.2	3,480	2,610
		210	0.7	<0.2	3,180	1,270	210	0.7	<0.2	3,180	1,590	210	0.8	<0.2	2,490	1,250
Mold steel (NAK80, HPM1, P21) 38-43HRC	JC8015 (DH102)	~90	0.7	<0.2	3,180	1,530	~90	0.7	<0.2	3,180	1,910	~100	0.8	<0.2	2,490	1,500
		140	0.7	<0.2	3,180	1,220	140	0.7	<0.2	3,180	1,520	150	0.8	<0.2	2,490	1,500
		210	0.7	<0.2	2,270	730	210	0.7	<0.2	2,270	910	210	0.8	<0.2	1,780	720
Hardened die steel (SKD61, DAC, DHA) 42-52HRC	DH102 (JC8015)	~90	0.7	<0.15	2,160	860	~90	0.7	<0.15	2,160	1,080	~100	0.8	<0.15	1,690	850
		140	0.7	<0.15	2,160	690	140	0.7	<0.15	2,160	860	150	0.8	<0.15	1,690	850
		210	0.7	<0.15	1,540	410	210	0.7	<0.15	1,540	510	210	0.8	<0.15	1,210	410
Grey & Nodular cast iron (FC, FCD) below 300HB	JC8015 (DH102)	~90	0.7	<0.2	7,000	4,200	~90	0.7	<0.2	7,000	5,250	~100	0.8	<0.2	5,470	4,100
		140	0.7	<0.2	5,730	2,750	140	0.7	<0.2	5,730	3,440	150	0.8	<0.2	5,470	4,100
		210	0.7	<0.2	5,730	2,290	210	0.7	<0.2	5,730	2,860	210	0.8	<0.2	4,480	2,240

Note

1. Please adjust cutting conditions according to machine rigidity or work rigidity.
2. In case of chatter occurring, recommended to reduce ap or rpm and keep feed per tooth.
3. ap should be reduced when using on low rigidity machine.
4. Use air blow.

QM MAX**MQX/QXP Type**

■ Recommended cutting conditions

● MQX Type (YPHW-15 /-F insert) - Vertical side finishing (UP&DOWN milling)

4

Material	Grade	Tool dia.(mm)														
		32/35					40/42					40				
		6N					6N					7N				
		ℓ (mm)	Pf (mm)	ae (mm)	n (min ⁻¹)	Vf (mm/min)	ℓ (mm)	Pf (mm)	ae (mm)	n (min ⁻¹)	Vf (mm/min)	ℓ (mm)	Pf (mm)	ae (mm)	n (min ⁻¹)	Vf (mm/min)
Carbon steel (S50C, S55C) below 250HB	JC8015 (DH102)	~100	0.8	<0.2	4,480	4,830	~100	0.88	<0.2	3,580	3,870	~100	0.88	<0.2	3,580	4,520
		150	0.8	<0.2	4,480	4,830	150	0.88	<0.2	3,580	3,870	150	0.88	<0.2	3,580	4,520
		210	0.8	<0.2	3,480	3,130	210	0.88	<0.2	2,790	2,010	210	0.88	<0.2	2,790	2,350
Tool & die steel (SKD61, SKD11) below 255HB	JC8015 (DH102)	~100	0.8	<0.2	3,980	4,300	~100	0.88	<0.2	3,180	3,430	~100	0.88	<0.2	3,180	4,000
		150	0.8	<0.2	3,980	4,300	150	0.88	<0.2	3,180	3,430	150	0.88	<0.2	3,180	4,000
		210	0.8	<0.2	2,980	2,090	210	0.88	<0.2	2,390	1,720	210	0.88	<0.2	2,390	2,010
Mold steel (HPM7, PX5, P20) 30-36 HRC	JC8015 (DH102)	~100	0.8	<0.2	3,480	3,130	~100	0.88	<0.2	2,790	2,510	~100	0.88	<0.2	2,790	2,930
		150	0.8	<0.2	3,480	3,130	150	0.88	<0.2	2,790	2,510	150	0.88	<0.2	2,790	2,930
		210	0.8	<0.2	2,490	1,500	210	0.88	<0.2	1,990	1,430	210	0.88	<0.2	1,990	1,670
Mold steel (NAK80, HPM1, P21) 38-43HRC	JC8015 (DH102)	~100	0.8	<0.2	2,490	1,800	~100	0.88	<0.2	1,990	1,430	~100	0.88	<0.2	1,990	1,670
		150	0.8	<0.2	2,490	1,800	150	0.88	<0.2	1,990	1,430	150	0.88	<0.2	1,990	1,670
		210	0.8	<0.2	1,780	860	210	0.88	<0.2	1,420	820	210	0.88	<0.2	1,420	960
Hardened die steel (SKD61, DAC, DHA) 42-52HRC	DH102 (JC8015)	~100	0.8	<0.15	1,690	1,020	~100	0.88	<0.15	1,350	810	~100	0.88	<0.15	1,350	950
		150	0.8	<0.15	1,690	1,020	150	0.88	<0.15	1,350	810	150	0.88	<0.15	1,350	950
		210	0.8	<0.15	1,210	490	210	0.88	<0.15	960	460	210	0.88	<0.15	960	540
Grey & Nodular cast iron (FC, FCD) below 300HB	JC8015 (DH102)	~100	0.8	<0.2	5,470	4,920	~100	0.88	<0.2	4,380	3,940	~100	0.88	<0.2	4,380	4,600
		150	0.8	<0.2	5,470	4,920	150	0.88	<0.2	4,380	3,940	150	0.88	<0.2	4,380	4,600
		210	0.8	<0.2	4,480	2,690	210	0.88	<0.2	3,580	2,580	210	0.88	<0.2	3,580	3,010

Note

1. Please adjust cutting conditions according to machine rigidity or work rigidity.
2. In case of chatter occurring, recommended to reduce ap or rpm and keep feed per tooth.
3. ap should be reduced when using on low rigidity machine.
4. Use air blow.

QM MAX**MQX/QXP Type**

■ Recommended cutting conditions

● QXP Type (YPHW-15 /-F insert) - Vertical side finishing (UP&DOWN milling)

4

Material	Grade	Tool dia.(mm)									
		40									
		6N					7N				
ℓ (mm)	P_f (mm)	a_e (mm)	n (min ⁻¹)	V_f (mm/min)	ℓ (mm)	P_f (mm)	a_e (mm)	n (min ⁻¹)	V_f (mm/min)		
Carbon steel (S50C, S55C) below 250HB	JC8015 (DH102)	~150	0.88	<0.2	3,580	3,870	~150	0.88	<0.2	3,580	4,520
		200	0.88	<0.2	3,580	3,870	200	0.88	<0.2	3,580	4,520
		250	0.88	<0.2	3,580	3,220	250	0.88	<0.2	3,580	3,760
		300	0.88	<0.2	2,790	2,010	300	0.88	<0.2	2,790	2,350
		350	-	-	-	-	350	-	-	-	-
Tool & die steel (SKD61, SKD11) below 255HB	JC8015 (DH102)	~150	0.88	<0.2	3,180	3,430	~150	0.88	<0.2	3,180	4,000
		200	0.88	<0.2	3,180	3,430	200	0.88	<0.2	3,180	4,000
		250	0.88	<0.2	3,180	2,860	250	0.88	<0.2	3,180	3,340
		300	0.88	<0.2	2,390	1,720	300	0.88	<0.2	2,390	2,010
		350	-	-	-	-	350	-	-	-	-
Mold steel (HPM7, PX5, P20) 30-36 HRC	JC8015 (DH102)	~150	0.88	<0.2	2,790	2,510	~150	0.88	<0.2	2,790	2,930
		200	0.88	<0.2	2,790	2,510	200	0.88	<0.2	2,790	2,930
		250	0.88	<0.2	2,790	2,010	250	0.88	<0.2	2,790	2,350
		300	0.88	<0.2	1,990	1,190	300	0.88	<0.2	1,990	1,390
		350	-	-	-	-	350	-	-	-	-
Mold steel (NAK80, HPM1, P21) 38-43HRC	JC8015 (DH102)	~150	0.88	<0.2	1,990	1,430	~150	0.88	<0.2	1,990	1,670
		200	0.88	<0.2	1,990	1,430	200	0.88	<0.2	1,990	1,670
		250	0.88	<0.2	1,990	1,150	250	0.88	<0.2	1,990	1,340
		300	0.88	<0.2	1,420	680	300	0.88	<0.2	1,420	790
		350	-	-	-	-	350	-	-	-	-
Hardened die steel (SKD61, DAC, DHA) 42-52HRC	DH102 (JC8015)	~150	0.88	<0.15	1,350	810	~150	0.88	<0.15	1,350	950
		200	0.88	<0.15	1,350	810	200	0.88	<0.15	1,350	950
		250	0.88	<0.15	1,350	650	250	0.88	<0.15	1,350	760
		300	0.88	<0.15	960	390	300	0.88	<0.15	960	460
		350	-	-	-	-	350	-	-	-	-
Grey & Nodular cast iron (FC, FCD) below 300HB	JC8015 (DH102)	~150	0.88	<0.2	4,380	3,940	~150	0.88	<0.2	4,380	4,600
		200	0.88	<0.2	4,380	3,940	200	0.88	<0.2	4,380	4,600
		250	0.88	<0.2	3,580	2,580	250	0.88	<0.2	3,580	3,010
		300	0.88	<0.2	3,580	2,150	300	0.88	<0.2	3,580	2,510
		350	-	-	-	-	350	-	-	-	-

Note

1. Please adjust cutting conditions according to machine rigidity or work rigidity.
2. In case of chatter occurring, recommended to reduce a_p or rpm and keep feed per tooth.
3. a_p should be reduced when using on low rigidity machine.
4. Use air blow.

QM MAX**MQX/QXP Type**

■ Recommended cutting conditions

● QXP Type (YPHW-15 /-F insert) - Vertical side finishing (UP & DOWN milling)

4

Material	Grade	Tool dia.(mm)									
		50					50/52				
		7N					8N				
ℓ (mm)	P_f (mm)	a_e (mm)	n (min ⁻¹)	V_f (mm/min)	ℓ (mm)	P_f (mm)	a_e (mm)	n (min ⁻¹)	V_f (mm/min)	V_f (mm/min)	
Carbon steel (S50C, S55C) below 255HB	JC8015 (DH102)	~150	1	<0.2	2,860	3,600	~150	1	<0.2	2,860	4,110
		200	1	<0.2	2,860	3,600	200	1	<0.2	2,860	4,110
		250	1	<0.2	2,860	3,600	250	1	<0.2	2,860	4,110
		300	1	<0.2	2,860	3,000	300	1	<0.2	2,860	3,430
		350	1	<0.2	2,860	3,000	350	1	<0.2	2,860	3,430
Tool & die steel (SKD61, SKD11) below 255HB	JC8015 (DH102)	~150	1	<0.2	2,550	3,210	~150	1	<0.2	2,550	3,670
		200	1	<0.2	2,550	3,210	200	1	<0.2	2,550	3,670
		250	1	<0.2	2,550	3,210	250	1	<0.2	2,550	3,670
		300	1	<0.2	2,550	2,680	300	1	<0.2	2,550	3,060
		350	1	<0.2	2,550	2,680	350	1	<0.2	2,550	3,060
Mold steel (HPM7, PX5, P20) 30-36 HRC	JC8015 (DH102)	~150	1	<0.2	2,230	2,340	~150	1	<0.2	2,230	2,670
		200	1	<0.2	2,230	2,340	200	1	<0.2	2,230	2,670
		250	1	<0.2	2,230	2,340	250	1	<0.2	2,230	2,670
		300	1	<0.2	2,230	1,870	300	1	<0.2	2,230	2,140
		350	1	<0.2	2,230	1,870	350	1	<0.2	2,230	2,140
Mold steel (NAK80, HPM1, P21) 38-43HRC	JC8015 (DH102)	~150	1	<0.2	1,590	1,340	~150	1	<0.2	1,590	1,530
		200	1	<0.2	1,590	1,340	200	1	<0.2	1,590	1,530
		250	1	<0.2	1,590	1,340	250	1	<0.2	1,590	1,530
		300	1	<0.2	1,590	1,070	300	1	<0.2	1,590	1,220
		350	1	<0.2	1,590	1,070	350	1	<0.2	1,590	1,220
Hardened die steel (SKD61, DAC, DHA) 42-52HRC	DH102 (JC8015)	~150	1	<0.15	1,080	760	~150	1	<0.15	1,080	870
		200	1	<0.15	1,080	760	200	1	<0.15	1,080	870
		250	1	<0.15	1,080	760	250	1	<0.15	1,080	870
		300	1	<0.15	1,080	610	300	1	<0.15	1,080	700
		350	1	<0.15	1,080	610	350	1	<0.15	1,080	700
Grey & Nodular cast iron (FC, FCD) below 300HB	JC8015 (DH102)	~150	1	<0.2	3,500	3,680	~150	1	<0.2	3,500	4,210
		200	1	<0.2	3,500	3,680	200	1	<0.2	3,500	4,210
		250	1	<0.2	3,500	3,680	250	1	<0.2	3,500	4,210
		300	1	<0.2	2,860	2,400	300	1	<0.2	2,860	2,740
		350	1	<0.2	2,860	2,400	350	1	<0.2	2,860	2,740

Note

1. Please adjust cutting conditions according to machine rigidity or work rigidity.
2. In case of chatter occurring, recommended to reduce a_p or rpm and keep feed per tooth.
3. a_p should be reduced when using on low rigidity machine.
4. Use air blow.

QM MAX**MQX/QXP Type**

■ Recommended cutting conditions

● QXP Type (YPHW-15 /-F insert) - Vertical side finishing (UP & DOWN milling)

4

Material	Grade	Tool dia.(mm)									
		63/66									
		8N									
φ (mm)	Pf (mm)	ae (mm)	n (min ⁻¹)	Vf (mm/min)							
Carbon steel (S50C, S55C) below 250HB	JC8015 (DH102)	~200	1.12	<0.2	2,270	3,260					
		250	1.12	<0.2	2,270	3,260					
		300	1.12	<0.2	2,270	3,260					
		350	1.12	<0.2	2,270	2,720					
		400	1.12	<0.2	2,270	2,720					
Tool & die steel (SKD61, SKD11) below 255HB	JC8015 (DH102)	~200	1.12	<0.2	2,020	2,910					
		250	1.12	<0.2	2,020	2,910					
		300	1.12	<0.2	2,020	2,910					
		350	1.12	<0.2	2,020	2,420					
		400	1.12	<0.2	2,020	2,420					
Mold steel (HPM7, PX5, P20) 30-36 HRC	JC8015 (DH102)	~200	1.12	<0.2	1,770	2,120					
		250	1.12	<0.2	1,770	2,120					
		300	1.12	<0.2	1,770	2,120					
		350	1.12	<0.2	1,770	1,700					
		400	1.12	<0.2	1,770	1,700					
Mold steel (NAK80, HPM1, P21) 38-43HRC	JC8015 (DH102)	~200	1.12	<0.2	1,260	1,210					
		250	1.12	<0.2	1,260	1,210					
		300	1.12	<0.2	1,260	1,210					
		350	1.12	<0.2	1,260	970					
		400	1.12	<0.2	1,260	970					
Hardened die steel (SKD61, DAC, DHA) 42-52HRC	DH102 (JC8015)	~200	1.12	<0.15	860	690					
		250	1.12	<0.15	860	690					
		300	1.12	<0.15	860	690					
		350	1.12	<0.15	860	550					
		400	1.12	<0.15	860	550					
Grey & Nodular cast iron (FC, FCD) below 300HB	JC8015 (DH102)	~200	1.12	<0.2	2,780	3,340					
		250	1.12	<0.2	2,780	3,340					
		300	1.12	<0.2	2,780	3,340					
		350	1.12	<0.2	2,270	2,180					
		400	1.12	<0.2	2,270	2,180					

Note

1. Please adjust cutting conditions according to machine rigidity or work rigidity.
2. In case of chatter occurring, recommended to reduce ap or rpm and keep feed per tooth.
3. ap should be reduced when using on low rigidity machine.
4. Use air blow.

QM MAX**MQX/QXP Type**

■ Recommended cutting conditions

● MQX Type (YPHW-15 /-F insert) - Side finishing

4

Material	Grade	Tool dia.(mm)														
		16/17					20					20/21				
		2N					3N					4N				
		ℓ (mm)	ap (mm)	ae (mm)	n (min ⁻¹)	Vf (mm/min)	ℓ (mm)	ap (mm)	ae (mm)	n (min ⁻¹)	Vf (mm/min)	ℓ (mm)	ap (mm)	ae (mm)	n (min ⁻¹)	Vf (mm/min)
Carbon steel (S50C, S55C) below 250HB	CX75 (JC8015) (DH102)	~70	1.5	<0.2	12,900	3,870	~70	1.5	<0.2	10,300	4,640	~70	1.5	<0.2	10,300	6,190
		120	1	<0.2	8,950	2,150	120	1	<0.2	7,160	2,580	120	1	<0.2	7,160	3,440
		160	0.7	<0.2	8,950	1,790	190	0.7	<0.2	7,160	2,150	190	0.7	<0.2	7,160	2,870
Tool & die steel (SKD61, SKD11) below 255HB	CX75 (JC8015) (DH102)	~70	1.5	<0.2	8,950	2,680	~70	1.5	<0.2	7,160	3,220	~70	1.5	<0.2	7,160	4,290
		120	1	<0.2	8,950	2,150	120	1	<0.2	7,160	2,580	120	1	<0.2	7,160	3,440
		160	0.7	<0.2	6,960	1,390	190	0.7	<0.2	5,570	1,670	190	0.7	<0.2	5,570	2,230
Mold steel (HPM7, PX5, P20) 30-36 HRC	JC8015 (DH102)	~70	1.5	<0.2	8,950	2,680	~70	1.5	<0.2	7,160	3,220	~70	1.5	<0.2	7,160	4,290
		120	1	<0.2	8,950	2,150	120	1	<0.2	7,160	2,580	120	1	<0.2	7,160	3,440
		160	0.7	<0.2	6,960	1,390	190	0.7	<0.2	5,570	1,670	190	0.7	<0.2	5,570	2,230
Mold steel (NAK80, HPM1, P21) 38-43HRC	JC8015 (DH102)	~70	1.5	<0.2	7,960	1,910	~70	1.5	<0.2	6,370	2,290	~70	1.5	<0.2	6,370	3,050
		120	1	<0.2	6,960	1,390	120	1	<0.2	5,570	1,670	120	1	<0.2	5,570	2,230
		160	0.7	<0.2	6,960	1,110	190	0.7	<0.2	5,570	1,340	190	0.7	<0.2	5,570	1,790
Hardened die steel (SKD61, DAC, DHA) 42-52HRC	JC8015 (DH102)	~70	1.5	<0.2	3,980	800	~70	1.5	<0.2	3,180	950	~70	1.5	<0.2	3,180	1,270
		120	1	<0.2	3,380	540	120	1	<0.2	2,710	630	120	1	<0.2	2,710	840
		160	-	-	-	-	190	-	-	-	-	190	-	-	-	-
Hardened die steel (SKD11, SLD, DC11) 55-62HRC	DH102	~70	1	<0.2	3,580	720	~70	1	<0.2	2,860	860	~70	1	<0.2	2,860	1,150
		120	0.7	<0.2	2,980	480	120	0.7	<0.2	2,390	570	120	0.7	<0.2	2,390	760
		160	-	-	-	-	190	-	-	-	-	190	-	-	-	-
Grey & Nodular cast iron (FC, FCD) below 300HB	JC8015 (DH102)	~70	1.5	<0.2	10,900	3,270	~70	1.5	<0.2	8,750	3,940	~70	1.5	<0.2	8,750	5,250
		120	1	<0.2	8,950	2,150	120	1	<0.2	7,160	2,580	120	1	<0.2	7,160	3,440
		160	0.7	<0.2	8,950	1,790	190	0.7	<0.2	7,160	2,150	190	0.7	<0.2	7,160	2,870
Stainless steel (SUS304) below 250HB	JC8015 (DH102)	~70	1.5	<0.2	8,950	2,680	~70	1.5	<0.2	7,160	3,220	~70	1.5	<0.2	7,160	4,290
		120	1	<0.2	8,950	2,150	120	1	<0.2	7,160	2,580	120	1	<0.2	7,160	3,440
		160	0.7	<0.2	6,960	1,390	190	0.7	<0.2	5,570	1,670	190	0.7	<0.2	5,570	2,230
Titanium alloy (Ti-6Al-4V)	JC8015 (DH102)	~70	1.5	<0.2	1,790	430	~70	1.5	<0.2	1,430	520	~70	1.5	<0.2	1,430	690
		120	1	<0.2	1,390	280	120	1	<0.2	1,110	330	120	1	<0.2	1,110	440
		160	0.7	<0.2	1,390	220	190	0.7	<0.2	1,110	270	190	0.7	<0.2	1,110	360

Note

1. Please adjust cutting conditions according to machine rigidity or work rigidity.
2. In case of chatter occurring, recommended to reduce ap or rpm and keep feed per tooth.
3. ap should be reduced when using on low rigidity machine.
4. Use air blow.

QM MAX**MQX/QXP Type**

■ Recommended cutting conditions

● MQX Type (YPHW-15 /-F insert) - Side finishing

4

Material	Grade	Tool dia.(mm)									
		25/26					25/26/28				
		4N					5N				
		ℓ (mm)	a _p (mm)	a _e (mm)	n (min ⁻¹)	V _f (mm/min)	ℓ (mm)	a _p (mm)	a _e (mm)	n (min ⁻¹)	V _f (mm/min)
Carbon steel (S50C, S55C) below 250HB	CX75 (JC8015) (DH102)	~90	1.5	<0.2	8,280	4,970	~90	1.5	<0.2	8,280	6,210
		140	1	<0.2	5,730	2,750	140	1	<0.2	5,730	3,440
		210	0.7	<0.2	5,730	2,290	210	0.7	<0.2	5,730	2,860
Tool & die steel (SKD61, SKD11) below 255HB	CX75 (JC8015) (DH102)	~90	1.5	<0.2	5,730	3,440	~90	1.5	<0.2	5,730	4,300
		140	1	<0.2	5,730	2,750	140	1	<0.2	5,730	3,440
		210	0.7	<0.2	4,460	1,780	210	0.7	<0.2	4,460	2,230
Mold steel (HPM7, PX5, P20) 30-36 HRC	JC8015 (DH102)	~90	1.5	<0.2	5,730	3,440	~90	1.5	<0.2	5,730	4,300
		140	1	<0.2	5,730	2,750	140	1	<0.2	5,730	3,440
		210	0.7	<0.2	4,460	1,780	210	0.7	<0.2	4,460	2,230
Mold steel (NAK80, HPM1, P21) 38-43HRC	JC8015 (DH102)	~90	1.5	<0.2	5,090	2,440	~90	1.5	<0.2	5,090	3,050
		140	1	<0.2	4,460	1,780	140	1	<0.2	4,460	2,230
		210	0.7	<0.2	4,460	1,430	210	0.7	<0.2	4,460	1,790
Hardened die steel (SKD61, DAC, DHA) 42-52HRC	JC8015 (DH102)	~90	1.5	<0.2	2,550	1,020	~90	1.5	<0.2	2,550	1,280
		140	1	<0.2	2,160	690	140	1	<0.2	2,160	860
		210	-	-	-	-	210	-	-	-	-
Hardened die steel (SKD11, SLD, DC11) 55-62HRC	DH102	~90	1	<0.2	2,290	920	~90	1	<0.2	2,290	1,150
		140	0.7	<0.2	1,910	610	140	0.7	<0.2	1,910	760
		210	-	-	-	-	210	-	-	-	-
Grey & Nodular cast iron (FC, FCD) below 300HB	JC8015 (DH102)	~90	1.5	<0.2	7,000	4,200	~90	1.5	<0.2	7,000	5,250
		140	1	<0.2	5,730	2,750	140	1	<0.2	5,730	3,440
		210	0.7	<0.2	5,730	2,290	210	0.7	<0.2	5,730	2,860
Stainless steel (SUS304) below 250HB	JC8015 (DH102)	~90	1.5	<0.2	5,730	3,440	~90	1.5	<0.2	5,730	4,300
		140	1	<0.2	5,730	2,750	140	1	<0.2	5,730	3,440
		210	0.7	<0.2	4,460	1,780	210	0.7	<0.2	4,460	2,230
Titanium alloy (Ti-6Al-4V)	JC8015 (DH102)	~90	1.5	<0.2	1,150	550	~90	1.5	<0.2	1,150	690
		140	1	<0.2	890	360	140	1	<0.2	890	450
		210	0.7	<0.2	890	280	210	0.7	<0.2	890	350

Note

1. Please adjust cutting conditions according to machine rigidity or work rigidity.
2. In case of chatter occurring, recommended to reduce a_p or rpm and keep feed per tooth.
3. a_p should be reduced when using on low rigidity machine.
4. Use air blow.

QM MAX**MQX/QXP Type**

- Recommended cutting conditions
- MQX Type (YPHW-15 /-F insert) - Side finishing

4

Material	Grade	Tool dia.(mm)									
		30/32/35					32/35				
		5N					6N				
		ℓ (mm)	a _p (mm)	a _e (mm)	n (min ⁻¹)	V _f (mm/min)	ℓ (mm)	a _p (mm)	a _e (mm)	n (min ⁻¹)	V _f (mm/min)
Carbon steel (S50C, S55C) below 250HB	CX75 (JC8015) (DH102)	~100	1.5	<0.2	6,470	4,850	~100	1.5	<0.2	6,470	5,820
		150	1.2	<0.2	4,480	2,690	150	1.2	<0.2	4,480	3,230
		210	1	<0.2	4,480	2,240	210	1	<0.2	4,480	2,690
Tool & die steel (SKD61, SKD11) below 255HB	CX75 (JC8015) (DH102)	~100	1.5	<0.2	4,480	3,360	~100	1.5	<0.2	4,480	4,030
		150	1.2	<0.2	4,480	2,690	150	1.2	<0.2	4,480	3,230
		210	1	<0.2	3,480	1,740	210	1	<0.2	3,480	2,090
Mold steel (HPM7, PX5, P20) 30-36 HRC	JC8015 (DH102)	~100	1.5	<0.2	4,480	3,360	~100	1.5	<0.2	4,480	4,030
		150	1.2	<0.2	4,480	2,690	150	1.2	<0.2	4,480	3,230
		210	1	<0.2	3,480	1,740	210	1	<0.2	3,480	2,090
Mold steel (NAK80, HPM1, P21) 38-43HRC	JC8015 (DH102)	~100	1.5	<0.2	3,980	2,390	~100	1.5	<0.2	3,980	2,870
		150	1.2	<0.2	3,480	1,740	150	1.2	<0.2	3,480	2,090
		210	1	<0.2	3,480	1,390	210	1	<0.2	3,480	1,670
Hardened die steel (SKD61, DAC, DHA) 42-52HRC	JC8015 (DH102)	~100	1.5	<0.2	2,000	1,000	~100	1.5	<0.2	2,000	1,200
		150	1.2	<0.2	1,690	680	150	1.2	<0.2	1,690	820
		210	1	<0.2	1,690	680	210	1	<0.2	1,690	820
Hardened die steel (SKD11, SLD, DC11) 55-62HRC	DH102	~100	1	<0.2	1,790	900	~100	1	<0.2	1,790	1,080
		150	0.8	<0.2	1,490	600	150	0.8	<0.2	1,490	720
		210	0.7	<0.2	1,490	420	210	0.7	<0.2	1,490	500
Grey & Nodular cast iron (FC, FCD) below 300HB	JC8015 (DH102)	~100	1.5	<0.2	5,470	4,100	~100	1.5	<0.2	5,470	4,920
		150	1.2	<0.2	4,480	2,690	150	1.2	<0.2	4,480	3,230
		210	1	<0.2	4,480	2,240	210	1	<0.2	4,480	2,690
Stainless steel (SUS304) below 250HB	JC8015 (DH102)	~100	1.5	<0.2	4,480	3,360	~100	1.5	<0.2	4,480	4,030
		150	1.2	<0.2	4,480	2,690	150	1.2	<0.2	4,480	3,230
		210	1	<0.2	3,480	1,740	210	1	<0.2	3,480	2,090
Titanium alloy (Ti-6Al-4V)	JC8015 (DH102)	~100	1.5	<0.2	900	540	~100	1.5	<0.2	900	650
		150	1.2	<0.2	700	350	150	1.2	<0.2	700	420
		210	1	<0.2	700	280	210	1	<0.2	700	340

Note

1. Please adjust cutting conditions according to machine rigidity or work rigidity.
2. In case of chatter occurring, recommended to reduce a_p or rpm and keep feed per tooth.
3. a_p should be reduced when using on low rigidity machine.
4. Use air blow.

QM MAX**MQX/QXP Type**

■ Recommended cutting conditions

● MQX Type (YPHW-15 /-F insert) - Side finishing

4

Material	Grade	Tool dia.(mm)									
		40/42					40				
		6N					7N				
		ℓ (mm)	a _p (mm)	a _e (mm)	n (min ⁻¹)	V _f (mm/min)	ℓ (mm)	a _p (mm)	a _e (mm)	n (min ⁻¹)	V _f (mm/min)
Carbon steel (S50C, S55C) below 250HB	CX75 (JC8015) (DH102)	~100	1.5	<0.2	5,170	4,650	~100	1.5	<0.2	5,170	5,420
		150	1.5	<0.2	5,170	4,650	150	1.5	<0.2	5,170	5,420
		210	1	<0.2	3,580	2,580	210	1	<0.2	3,580	3,010
Tool & die steel (SKD61, SKD11) below 255HB	CX75 (JC8015) (DH102)	~100	1.5	<0.2	3,580	3,220	~100	1.5	<0.2	3,580	3,760
		150	1.5	<0.2	3,580	3,220	150	1.5	<0.2	3,580	3,760
		210	1	<0.2	2,790	2,010	210	1	<0.2	2,790	2,350
Mold steel (HPM7, PX5, P20) 30-36 HRC	JC8015 (DH102)	~100	1.5	<0.2	3,580	3,220	~100	1.5	<0.2	3,580	3,760
		150	1.5	<0.2	3,580	3,220	150	1.5	<0.2	3,580	3,760
		210	1	<0.2	2,790	2,010	210	1	<0.2	2,790	2,350
Mold steel (NAK80, HPM1, P21) 38-43HRC	JC8015 (DH102)	~100	1.5	<0.2	3,180	2,290	~100	1.5	<0.2	3,180	2,670
		150	1.5	<0.2	3,180	2,290	150	1.5	<0.2	3,180	2,670
		210	1	<0.2	2,790	1,670	210	1	<0.2	2,790	1,950
Hardened die steel (SKD61, DAC, DHA) 42-52HRC	JC8015 (DH102)	~100	1.5	<0.2	1,590	950	~100	1.5	<0.2	1,590	1,110
		150	1.5	<0.2	1,590	950	150	1.5	<0.2	1,350	1,110
		210	1	<0.2	1,350	650	210	1	<0.2	1,350	760
Hardened die steel (SKD11, SLD, DC11) 55-62HRC	DH102	~100	1	<0.2	1,430	860	~100	1	<0.2	1,430	1,000
		150	1	<0.2	1,430	860	150	1	<0.2	1,430	1,000
		210	0.7	<0.2	1,190	570	210	0.7	<0.2	1,190	670
Grey & Nodular cast iron (FC, FCD) below 300HB	JC8015 (DH102)	~100	1.5	<0.2	4,380	3,940	~100	1.5	<0.2	4,380	4,600
		150	1.5	<0.2	3,580	3,940	150	1.5	<0.2	3,580	4,600
		210	1	<0.2	3,580	2,580	210	1	<0.2	3,580	3,010
Stainless steel (SUS304) below 250HB	JC8015 (DH102)	~100	1.5	<0.2	3,580	3,220	~100	1.5	<0.2	3,580	3,760
		150	1.5	<0.2	3,580	3,220	150	1.5	<0.2	3,580	3,760
		210	1	<0.2	2,790	2,010	210	1	<0.2	2,790	2,350
Titanium alloy (Ti-6Al-4V)	JC8015 (DH102)	~100	1.5	<0.2	720	520	~100	1.5	<0.2	720	610
		150	1.5	<0.2	560	520	150	1.5	<0.2	560	610
		210	1	<0.2	560	340	210	1	<0.2	560	400

Note

1. Please adjust cutting conditions according to machine rigidity or work rigidity.
2. In case of chatter occurring, recommended to reduce a_p or rpm and keep feed per tooth.
3. a_p should be reduced when using on low rigidity machine.
4. Use air blow.

QM MAX**MQX/QXP Type**

■ Recommended cutting conditions

● QXP Type (YPHW-15 /-F insert) - Side finishing

4

Material	Grade	Tool dia.(mm)									
		40									
		6N					7N				
		ϕ (mm)	a_p (mm)	a_e (mm)	n (min ⁻¹)	V_f (mm/min)	ϕ (mm)	a_p (mm)	a_e (mm)	n (min ⁻¹)	V_f (mm/min)
Carbon steel (S50C, S55C) below 250HB	CX75 (JC8015) (DH102)	~150	1.5	<0.2	5,170	4,650	~150	1.5	<0.2	5,170	5,430
		200	1.5	<0.2	5,170	4,650	200	1.5	<0.2	5,170	5,430
		250	1	<0.2	3,580	2,580	250	1	<0.2	3,580	3,010
		300	0.7	<0.2	3,580	2,360	300	0.7	<0.2	3,580	2,750
		350	-	-	-	-	350	-	-	-	-
Tool & die steel (SKD61, SKD11) below 255HB	CX75 (JC8015) (DH102)	~150	1.5	<0.2	3,580	3,220	~150	1.5	<0.2	3,580	3,760
		200	1.5	<0.2	3,580	3,220	200	1.5	<0.2	3,580	3,760
		250	1	<0.2	2,790	2,010	250	1	<0.2	2,790	2,350
		300	0.7	<0.2	2,790	1,670	300	0.7	<0.2	2,790	1,950
		350	-	-	-	-	350	-	-	-	-
Mold steel (HPM7, PX5, P20) 30-36 HRC	JC8015 (DH102)	~150	1.5	<0.2	3,580	3,220	~150	1.5	<0.2	3,580	3,760
		200	1.5	<0.2	3,580	3,220	200	1.5	<0.2	3,580	3,760
		250	1	<0.2	2,790	2,010	250	1	<0.2	2,790	2,350
		300	0.7	<0.2	2,790	1,670	300	0.7	<0.2	2,790	1,950
		350	-	-	-	-	350	-	-	-	-
Mold steel (NAK80, HPM1, P21) 38-43HRC	JC8015 (DH102)	~150	1.5	<0.2	3,180	2,290	~150	1.5	<0.2	3,180	2,670
		200	1.5	<0.2	3,180	2,290	200	1.5	<0.2	3,180	2,670
		250	1	<0.2	2,790	1,670	250	1	<0.2	2,790	1,950
		300	0.7	<0.2	2,790	1,340	300	0.7	<0.2	2,790	1,560
		350	-	-	-	-	350	-	-	-	-
Hardened die steel (SKD61, DAC, DHA) 42-52HRC	JC8015 (DH102)	~150	1.5	<0.2	1,590	950	~150	1.5	<0.2	1,590	1,110
		200	1.5	<0.2	1,590	950	200	1.5	<0.2	1,590	1,110
		250	1	<0.2	1,350	650	250	1	<0.2	1,350	760
		300	0.7	<0.2	1,350	650	300	0.7	<0.2	1,350	760
		350	-	-	-	-	350	-	-	-	-
Hardened die steel (SKD11, SLD, DC11) 55-62HRC	DH102	~150	1	<0.2	1,430	860	~150	1	<0.2	1,430	1,000
		200	1	<0.2	1,430	860	200	1	<0.2	1,430	1,000
		250	0.7	<0.2	1,190	570	250	0.7	<0.2	1,190	670
		300	0.5	<0.2	1,190	360	300	0.5	<0.2	1,190	420
		350	-	-	-	-	350	-	-	-	-
Grey & Nodular cast iron (FC, FCD) below 300HB	JC8015 (DH102)	~150	1.5	<0.2	4,380	3,940	~150	1.5	<0.2	4,380	4,600
		200	1.5	<0.2	4,380	3,940	200	1.5	<0.2	4,380	4,600
		250	1	<0.2	3,580	2,580	250	1	<0.2	3,580	3,010
		300	0.7	<0.2	3,580	2,150	300	0.7	<0.2	3,580	2,510
		350	-	-	-	-	350	-	-	-	-
Stainless steel (SUS304) below 250HB	JC8015 (DH102)	~150	1.5	<0.2	3,580	3,220	~150	1.5	<0.2	3,580	3,760
		200	1.5	<0.2	3,580	3,220	200	1.5	<0.2	3,580	3,760
		250	1	<0.2	2,790	2,010	250	1	<0.2	2,790	2,350
		300	0.7	<0.2	2,790	1,670	300	0.7	<0.2	2,790	1,950
		350	-	-	-	-	350	-	-	-	-
Titanium alloy (Ti-6Al-4V)	JC8015 (DH102)	~150	1.5	<0.2	720	520	~150	1.5	<0.2	720	610
		200	1.5	<0.2	720	520	200	1.5	<0.2	720	610
		250	1	<0.2	560	340	250	1	<0.2	560	400
		300	0.7	<0.2	560	270	300	0.7	<0.2	560	320
		350	-	-	-	-	350	-	-	-	-

Note

1. Please adjust cutting conditions according to machine rigidity or work rigidity.
2. In case of chatter occurring, recommended to reduce a_p or rpm and keep feed per tooth.
3. a_p should be reduced when using on low rigidity machine.
4. Use air blow.

QM MAX**MQX/QXP Type**

■ Recommended cutting conditions

● QXP Type (YPHW-15 /-F insert) - Side finishing

4

Material	Grade	Tool dia.(mm)									
		50					50/52				
		7N					8N				
φ (mm)	a_p (mm)	a_e (mm)	n (min ⁻¹)	V_f (mm/min)	φ (mm)	a_p (mm)	a_e (mm)	n (min ⁻¹)	V_f (mm/min)		
Carbon steel (S50C, S55C) below 250HB	CX75 (JC8015) (DH102)	~150	2	<0.2	4,140	4,350	~150	2	<0.2	4,140	4,970
		200	2	<0.2	4,140	4,350	200	2	<0.2	4,140	4,970
		250	2	<0.2	4,140	4,350	250	2	<0.2	4,140	4,970
		300	1.5	<0.2	2,860	2,400	300	1.5	<0.2	2,860	2,740
		350	1.5	<0.2	2,860	2,400	350	1.5	<0.2	2,860	2,740
Tool & die steel (SKD61, SKD11) below 255HB	CX75 (JC8015) (DH102)	~150	2	<0.2	2,860	3,000	~150	2	<0.2	2,860	3,430
		200	2	<0.2	2,860	3,000	200	2	<0.2	2,860	3,430
		250	2	<0.2	2,860	3,000	250	2	<0.2	2,860	3,430
		300	1.5	<0.2	2,860	2,400	300	1.5	<0.2	2,860	2,740
		350	1.5	<0.2	2,860	2,400	350	1.5	<0.2	2,860	2,740
Mold steel (HPM7, PX5, P20) 30-36 HRC	JC8015 (DH102)	~150	2	<0.2	2,860	3,000	~150	2	<0.2	2,860	3,430
		200	2	<0.2	2,860	3,000	200	2	<0.2	2,860	3,430
		250	2	<0.2	2,860	3,000	250	2	<0.2	2,860	3,430
		300	1.5	<0.2	2,860	2,400	300	1.5	<0.2	2,860	2,740
		350	1.5	<0.2	2,860	2,400	350	1.5	<0.2	2,860	2,740
Mold steel (NAK80, HPM1, P21) 38-43HRC	JC8015 (DH102)	~150	2	<0.2	2,550	2,140	~150	2	<0.2	2,550	2,450
		200	2	<0.2	2,550	2,140	200	2	<0.2	2,550	2,450
		250	2	<0.2	2,550	2,140	250	2	<0.2	2,550	2,450
		300	1.5	<0.2	2,230	1,560	300	1.5	<0.2	2,230	1,780
		350	1.5	<0.2	2,230	1,560	350	1.5	<0.2	2,230	1,780
Hardened die steel (SKD61, DAC, DHA) 42-52HRC	JC8015 (DH102)	~150	1.5	<0.2	1,270	890	~150	1.5	<0.2	1,270	1,020
		200	1.5	<0.2	1,270	890	200	1.5	<0.2	1,270	1,020
		250	1.5	<0.2	1,270	890	250	1.5	<0.2	1,270	1,020
		300	1.2	<0.2	1,080	600	300	1.2	<0.2	1,080	690
		350	1.2	<0.2	1,080	600	350	1.2	<0.2	1,080	690
Hardened die steel (SKD11, SLD, DC11) 55-62HRC	DH102	~150	1.5	<0.2	1,150	810	~150	1.5	<0.2	1,150	930
		200	1.5	<0.2	1,150	810	200	1.5	<0.2	1,150	930
		250	1.5	<0.2	1,150	810	250	1.5	<0.2	1,150	930
		300	1	<0.2	950	530	300	1	<0.2	950	610
		350	1	<0.2	950	530	350	1	<0.2	950	610
Grey & Nodular cast iron (FC, FCD) below 300HB	JC8015 (DH102)	~150	2	<0.2	3,500	3,680	~150	2	<0.2	3,500	4,210
		200	2	<0.2	3,500	3,680	200	2	<0.2	3,500	4,210
		250	2	<0.2	3,500	3,680	250	2	<0.2	3,500	4,210
		300	1.5	<0.2	2,860	2,400	300	1.5	<0.2	2,860	2,740
		350	1.5	<0.2	2,860	2,400	350	1.5	<0.2	2,860	2,740
Stainless steel (SUS304) below 250HB	JC8015 (DH102)	~150	2	<0.2	2,860	3,000	~150	2	<0.2	2,860	3,430
		200	2	<0.2	2,860	3,000	200	2	<0.2	2,860	3,430
		250	2	<0.2	2,860	3,000	250	2	<0.2	2,860	3,430
		300	1.5	<0.2	2,860	2,400	300	1.5	<0.2	2,860	2,740
		350	1.5	<0.2	2,860	2,400	350	1.5	<0.2	2,860	2,740
Titanium alloy (Ti-6Al-4V)	JC8015 (DH102)	~150	2	<0.2	570	480	~150	2	<0.2	570	550
		200	2	<0.2	570	480	200	2	<0.2	570	550
		250	2	<0.2	570	480	250	2	<0.2	570	550
		300	1.5	<0.2	450	320	300	1.5	<0.2	450	370
		350	1.5	<0.2	450	320	350	1.5	<0.2	450	370

Note

1. Please adjust cutting conditions according to machine rigidity or work rigidity.
2. In case of chatter occurring, recommended to reduce a_p or rpm and keep feed per tooth.
3. a_p should be reduced when using on low rigidity machine.
4. Use air blow.

QM MAX
MQX/QXP Type
Recommended cutting conditions
● QXP Type (YPHW-15 /-F insert) - Side finishing
4

Material	Grade	Tool dia.(mm)								
		63/66								
		8N								
φ (mm)	a_p (mm)	a_e (mm)	n (min ⁻¹)	V_f (mm/min)						
Carbon steel (S50C, S55C) below 250HB	CX75 (JC8015) (DH102)	~200	2	<0.2	3,290	3,950				
		250	2	<0.2	3,290	3,950				
		300	2	<0.2	3,290	3,950				
		350	1.5	<0.2	2,270	2,180				
		400	1.5	<0.2	2,270	2,180				
Tool & die steel (SKD61, SKD11) below 255HB	CX75 (JC8015) (DH102)	~200	2	<0.2	2,270	2,720				
		250	2	<0.2	2,270	2,720				
		300	2	<0.2	2,270	2,720				
		350	1.5	<0.2	2,270	2,180				
		400	1.5	<0.2	2,270	2,180				
Mold steel (HPM7, PX5, P20) 30-36 HRC	JC8015 (DH102)	~200	2	<0.2	2,270	2,720				
		250	2	<0.2	2,270	2,720				
		300	2	<0.2	2,270	2,720				
		350	1.5	<0.2	2,270	2,180				
		400	1.5	<0.2	2,270	2,180				
Mold steel (NAK80, HPM1, P21) 38-43HRC	JC8015 (DH102)	~200	2	<0.2	2,020	1,940				
		250	2	<0.2	2,020	1,940				
		300	2	<0.2	2,020	1,940				
		350	1.5	<0.2	1,770	1,410				
		400	1.5	<0.2	1,770	1,410				
Hardened die steel (SKD61, DAC, DHA) 42-52HRC	JC8015 (DH102)	~200	1.5	<0.2	1,010	810				
		250	1.5	<0.2	1,010	810				
		300	1.5	<0.2	1,010	810				
		350	1.2	<0.2	860	550				
		400	1.2	<0.2	860	550				
Hardened die steel (SKD11, SLD, DC11) 55-62HRC	DH102	~200	1.5	<0.2	910	740				
		250	1.5	<0.2	910	740				
		300	1.5	<0.2	910	740				
		350	1	<0.2	750	480				
		400	1	<0.2	750	480				
Grey & Nodular cast iron (FC, FCD) below 300HB	JC8015 (DH102)	~200	2	<0.2	2,780	3,340				
		250	2	<0.2	2,780	3,340				
		300	2	<0.2	2,780	3,340				
		350	1.5	<0.2	2,270	2,180				
		400	1.5	<0.2	2,270	2,180				
Stainless steel (SUS304) below 250HB	JC8015 (DH102)	~200	2	<0.2	2,270	2,720				
		250	2	<0.2	2,270	2,720				
		300	2	<0.2	2,270	2,720				
		350	1.5	<0.2	2,270	2,180				
		400	1.5	<0.2	2,270	2,180				
Titanium alloy (Ti-6Al-4V)	JC8015 (DH102)	~200	2	<0.2	450	440				
		250	2	<0.2	450	440				
		300	2	<0.2	450	440				
		350	1.5	<0.2	360	300				
		400	1.5	<0.2	360	300				

Note

1. Please adjust cutting conditions according to machine rigidity or work rigidity.
2. In case of chatter occurring, recommended to reduce a_p or rpm and keep feed per tooth.
3. a_p should be reduced when using on low rigidity machine.
4. Use air blow.

QM MAX**MQX/QXP Type**

■ Recommended cutting conditions

● MQX Type (YPHW-15 insert) - Bottom finishing

4

Material	Grade	Tool dia.(mm)														
		16/17					20					20/21				
		2N					3N					4N				
		ℓ (mm)	a _p (mm)	a _e (mm)	n (min ⁻¹)	V _f (mm/min)	ℓ (mm)	a _p (mm)	a _e (mm)	n (min ⁻¹)	V _f (mm/min)	ℓ (mm)	a _p (mm)	a _e (mm)	n (min ⁻¹)	V _f (mm/min)
Carbon steel (S50C, S55C) below 250HB	CX75 (DH102)	~70	0.2	8~16	5,200	2,600	~70	0.2	10~20	4,200	3,150	~70	0.2	10~18	4,200	4,200
		120	0.2	8~16	3,900	1,550	120	0.2	10~20	3,200	1,950	120	0.2	10~18	3,200	2,550
		160	0.2	8~10	3,400	1,200	190	0.2	10~12	2,700	1,450	190	0.2	10~12	2,700	1,900
Tool & die steel (SKD61, SKD11) below 255HB	CX75 (DH102)	~70	0.2	8~16	4,700	2,100	~70	0.2	10~20	3,800	2,550	~70	0.2	10~18	3,800	3,400
		120	0.2	8~16	3,500	1,400	120	0.2	10~20	2,900	1,750	120	0.2	10~18	2,900	2,350
		160	0.2	8~10	3,000	1,100	190	0.2	10~12	2,450	1,300	190	0.2	10~12	2,450	1,750
Mold steel (HPM7, PX5, P20) 30-36 HRC	DH102	~70	0.2	8~16	4,350	1,750	~70	0.2	10~20	3,500	2,100	~70	0.2	10~18	3,500	2,800
		120	0.2	8~16	3,250	1,200	120	0.2	10~20	2,650	1,450	120	0.2	10~18	2,650	1,950
		160	0.2	8~10	2,750	950	190	0.2	10~12	2,250	1,150	190	0.2	10~12	2,250	1,500
Mold steel (NAK80, HPM1, P21) 38-43HRC	DH102	~70	0.2	8~16	4,000	960	~70	0.2	10~20	3,200	1,150	~70	0.2	10~18	3,200	1,500
		120	0.2	8~16	3,000	600	120	0.2	10~20	2,400	720	120	0.2	10~18	2,400	960
		160	0.2	8~10	2,550	500	190	0.2	10~12	2,050	600	190	0.2	10~12	2,050	800
Hardened die steel (SKD61, DAC, DHA) 42-52HRC	DH102	~70	0.2	8~16	2,000	400	~70	0.2	10~20	1,600	480	~70	0.2	10~18	1,600	640
		120	0.2	8~16	1,600	320	120	0.2	10~20	1,280	380	120	0.2	10~18	1,280	510
		160	-	-	-	-	190	-	-	-	-	190	-	-	-	-
Hardened die steel (SKD11, SLD, DC11) 55-62HRC	DH102	~70	0.2	8~16	1,400	200	~70	0.2	10~20	1,120	240	~70	0.2	10~18	1,120	320
		120	0.2	8~16	1,000	100	120	0.2	10~20	800	120	120	0.2	10~18	800	160
		160	-	-	-	-	190	-	-	-	-	190	-	-	-	-
Grey & Nodular cast iron (FC, FCD) below 300HB	DH102	~70	0.2	8~16	4,000	1,600	~70	0.2	10~20	3,180	1,910	~70	0.2	10~18	3,180	2,540
		120	0.2	8~16	3,000	900	120	0.2	10~20	2,390	1,080	120	0.2	10~18	2,390	1,430
		160	0.2	8~10	2,600	520	190	0.2	10~12	2,070	630	190	0.2	10~12	2,070	830
Stainless steel (SUS304) below 250HB	JC8015 (DH102)	~70	0.2	8~16	3,600	1,080	~70	0.2	10~20	2,860	1,290	~70	0.2	10~18	2,860	1,720
		120	0.2	8~16	2,600	620	120	0.2	10~20	2,070	750	120	0.2	10~18	2,070	1,000
		160	0.2	8~10	2,000	400	190	0.2	10~12	1,590	480	190	0.2	10~12	1,590	640
Titanium alloy (Ti-6Al-4V)	DH102	~70	0.2	8~16	1,000	300	~70	0.2	10~20	800	360	~70	0.2	10~18	800	480
		120	0.2	8~16	600	120	120	0.2	10~20	480	150	120	0.2	10~18	480	200
		160	0.2	8~10	600	120	190	0.2	10~12	480	150	190	0.2	10~12	480	200

Note

1. Please adjust cutting conditions according to machine rigidity or work rigidity.
2. In case of chatter occurring, recommended to reduce a_p or rpm and keep feed per tooth.
3. a_p should be reduced when using on low rigidity machine.
4. Use air blow.
5. YPHW-F insert with lower feed is recommended for better surface finish in case chatter occurs.
Please scan QR code for cutting conditions of YPHW-F /-24 for bottom finishing.



QM MAX**MQX/QXP Type**

■ Recommended cutting conditions

● MQX Type (YPHW-15 insert) - Bottom finishing

4

Material	Grade	Tool dia.(mm)									
		25/26					25/26/28				
		4N					5N				
		ℓ (mm)	a_p (mm)	a_e (mm)	n (min ⁻¹)	V_f (mm/min)	ℓ (mm)	a_p (mm)	a_e (mm)	n (min ⁻¹)	V_f (mm/min)
Carbon steel (S50C, S55C) below 250HB	CX75 (DH102)	~90	0.2	12.5~25	3,400	3,400	~90	0.2	12.5~22	3,400	4,250
		140	0.2	12.5~25	2,500	2,000	140	0.2	12.5~22	2,500	2,500
		210	0.2	12.5~15	2,200	1,550	210	0.2	12.5~15	2,200	1,900
Tool & die steel (SKD61, SKD11) below 255HB	CX75 (DH102)	~90	0.2	12.5~25	3,050	2,750	~90	0.2	12.5~22	3,050	3,400
		140	0.2	12.5~25	2,250	1,800	140	0.2	12.5~22	2,250	2,250
		210	0.2	12.5~15	2,000	1,400	210	0.2	12.5~15	2,000	1,750
Mold steel (HPM7, PX5, P20) 30-36 HRC	DH102	~90	0.2	12.5~25	2,800	2,250	~90	0.2	12.5~22	2,800	2,800
		140	0.2	12.5~25	2,100	1,500	140	0.2	12.5~22	2,100	1,900
		210	0.2	12.5~15	1,800	1,200	210	0.2	12.5~15	1,800	1,500
Mold steel (NAK80, HPM1, P21) 38-43HRC	DH102	~90	0.2	12.5~25	2,550	1,250	~90	0.2	12.5~22	2,550	1,500
		140	0.2	12.5~25	1,900	750	140	0.2	12.5~22	1,900	950
		210	0.2	12.5~15	1,650	650	210	0.2	12.5~15	1,650	850
Hardened die steel (SKD61, DAC, DHA) 42-52HRC	DH102	~90	0.2	12.5~25	1,270	510	~90	0.2	12.5~22	1,270	640
		140	0.2	12.5~25	1,020	410	140	0.2	12.5~22	1,020	510
		210	-	-	-	-	210	-	-	-	-
Hardened die steel (SKD11, SLD, DC11) 55-62HRC	DH102	~90	0.2	12.5~25	890	250	~90	0.2	12.5~22	890	310
		140	0.2	12.5~25	640	130	140	0.2	12.5~22	640	160
		210	-	-	-	-	210	-	-	-	-
Grey & Nodular cast iron (FC, FCD) below 300HB	DH102	~90	0.2	12.5~25	2,550	2,040	~90	0.2	12.5~22	2,550	2,550
		140	0.2	12.5~25	1,910	1,150	140	0.2	12.5~22	1,910	1,440
		210	0.2	12.5~15	1,660	660	210	0.2	12.5~15	1,660	820
Stainless steel (SUS304) below 250HB	JC8015 (DH102)	~90	0.2	12.5~25	2,290	1,370	~90	0.2	12.5~22	2,290	1,710
		140	0.2	12.5~25	1,660	800	140	0.2	12.5~22	1,660	1,000
		210	0.2	12.5~15	1,270	510	210	0.2	12.5~15	1,270	640
Titanium alloy (Ti-6Al-4V)	DH102	~90	0.2	12.5~25	640	380	~90	0.2	12.5~22	640	480
		140	0.2	12.5~25	380	150	140	0.2	12.5~22	380	190
		210	0.2	12.5~15	380	150	210	0.2	12.5~15	380	190

Note

1. Please adjust cutting conditions according to machine rigidity or work rigidity.
2. In case of chatter occurring, recommended to reduce a_p or rpm and keep feed per tooth.
3. a_p should be reduced when using on low rigidity machine.
4. Use air blow.
5. YPHW-F insert with lower feed is recommended for better surface finish in case chatter occurs.
Please scan QR code for cutting conditions of YPHW-F /-24 for bottom finishing.



QM MAX**MQX/QXP Type**

■ Recommended cutting conditions

● MQX Type (YPHW-15 insert) - Bottom finishing

4

Material	Grade	Tool dia.(mm)									
		30/32/35					32/35				
		5N					6N				
		ℓ (mm)	a _p (mm)	a _e (mm)	n (min ⁻¹)	V _f (mm/min)	ℓ (mm)	a _p (mm)	a _e (mm)	n (min ⁻¹)	V _f (mm/min)
Carbon steel (S50C, S55C) below 250HB	CX75 (DH102)	~100	0.2	16~32	2,650	3,300	~100	0.2	16~30	2,650	3,950
		150	0.2	16~32	2,650	3,300	150	0.2	16~30	2,650	3,950
		210	0.2	16~32	2,000	2,000	210	0.2	16~30	2,000	2,400
Tool & die steel (SKD61, SKD11) below 255HB	CX75 (DH102)	~100	0.2	16~32	2,400	2,700	~100	0.2	16~30	2,400	3,200
		150	0.2	16~32	2,400	2,700	150	0.2	16~30	2,400	3,200
		210	0.2	16~32	1,800	1,800	210	0.2	16~30	1,800	2,150
Mold steel (HPM7, PX5, P20) 30-36 HRC	DH102	~100	0.2	16~32	2,200	2,200	~100	0.2	16~30	2,200	2,600
		150	0.2	16~32	2,200	2,200	150	0.2	16~30	2,200	2,600
		210	0.2	16~32	1,650	1,500	210	0.2	16~30	1,650	1,800
Mold steel (NAK80, HPM1, P21) 38-43HRC	DH102	~100	0.2	16~32	2,000	1,200	~100	0.2	16~30	2,000	1,450
		150	0.2	16~32	2,000	1,200	150	0.2	16~30	2,000	1,450
		210	0.2	16~32	1,500	750	210	0.2	16~30	1,500	900
Hardened die steel (SKD61, DAC, DHA) 42-52HRC	DH102	~100	0.2	16~32	1,000	500	~100	0.2	16~30	1,000	600
		150	0.2	16~32	1,000	500	150	0.2	16~30	1,000	600
		210	0.2	16~20	800	400	210	0.2	16~20	800	480
Hardened die steel (SKD11, SLD, DC11) 55-62HRC	DH102	~100	0.2	16~32	700	250	~100	0.2	16~30	700	300
		150	0.2	16~32	700	250	150	0.2	16~30	700	300
		210	0.2	16~20	500	130	210	0.2	16~20	500	160
Grey & Nodular cast iron (FC, FCD) below 300HB	DH102	~100	0.2	16~32	1,990	1,990	~100	0.2	16~30	1,990	2,390
		150	0.2	16~32	1,990	1,990	150	0.2	16~30	1,990	2,390
		210	0.2	16~32	1,490	1,120	210	0.2	16~30	1,490	1,340
Stainless steel (SUS304) below 250HB	JC8015 (DH102)	~100	0.2	16~32	1,790	1,340	~100	0.2	16~30	1,790	1,610
		150	0.2	16~32	1,790	1,340	150	0.2	16~30	1,790	1,610
		210	0.2	16~32	1,290	770	210	0.2	16~30	1,290	920
Titanium alloy (Ti-6Al-4V)	DH102	~100	0.2	16~32	500	380	~100	0.2	16~30	500	460
		150	0.2	16~32	500	380	150	0.2	16~30	500	460
		210	0.2	16~20	300	150	210	0.2	16~20	300	180

Note

1. Please adjust cutting conditions according to machine rigidity or work rigidity.
2. In case of chatter occurring, recommended to reduce a_p or rpm and keep feed per tooth.
3. a_p should be reduced when using on low rigidity machine.
4. Use air blow.
5. YPHW-F insert with lower feed is recommended for better surface finish in case chatter occurs.

Please scan QR code for cutting conditions of YPHW-F /-24 for bottom finishing.



QM MAX**MQX/QXP Type**

■ Recommended cutting conditions

● MQX Type (YPHW-15 insert) - Bottom finishing

4

Material	Grade	Tool dia.(mm)									
		40/42					40				
		6N					7N				
		ℓ (mm)	a_p (mm)	a_e (mm)	n (min ⁻¹)	V_f (mm/min)	ℓ (mm)	a_p (mm)	a_e (mm)	n (min ⁻¹)	V_f (mm/min)
Carbon steel (S50C, S55C) below 250HB	CX75 (DH102)	~100	0.2	20~40	2,100	3,150	~100	0.2	20~38	2,100	3,650
		150	0.2	20~40	2,100	3,150	150	0.2	20~38	2,100	3,650
		210	0.2	20~40	1,570	1,900	210	0.2	20~38	1,570	2,200
Tool & die steel (SKD61, SKD11) below 255HB	CX75 (DH102)	~100	0.2	20~40	1,890	2,850	~100	0.2	20~38	1,890	3,300
		150	0.2	20~40	1,890	2,850	150	0.2	20~38	1,890	3,300
		210	0.2	20~40	1,410	1,700	210	0.2	20~38	1,410	2,000
Mold steel (HPM7, PX5, P20) 30-36 HRC	DH102	~100	0.2	20~40	1,750	2,100	~100	0.2	20~38	1,750	2,450
		150	0.2	20~40	1,750	2,100	150	0.2	20~38	1,750	2,450
		210	0.2	20~40	1,300	1,400	210	0.2	20~38	1,300	1,650
Mold steel (NAK80, HPM1, P21) 38-43HRC	DH102	~100	0.2	20~40	1,600	1,150	~100	0.2	20~38	1,600	1,350
		150	0.2	20~40	1,600	1,150	150	0.2	20~38	1,600	1,350
		210	0.2	20~40	1,200	720	210	0.2	20~38	1,200	840
Hardened die steel (SKD61, DAC, DHA) 42-52HRC	DH102	~100	0.2	20~40	800	480	~100	0.2	20~38	800	560
		150	0.2	20~40	800	480	150	0.2	20~38	800	560
		210	0.2	20~40	640	380	210	0.2	20~38	640	440
Hardened die steel (SKD11, SLD, DC11) 55-62HRC	DH102	~100	0.2	20~40	560	240	~100	0.2	20~38	560	280
		150	0.2	20~40	560	240	150	0.2	20~38	560	280
		210	0.2	20~40	400	120	210	0.2	20~38	400	140
Grey & Nodular cast iron (FC, FCD) below 300HB	DH102	~100	0.2	20~40	1,590	1,910	~100	0.2	20~38	1,590	2,230
		150	0.2	20~40	1,590	1,910	150	0.2	20~38	1,590	2,230
		210	0.2	20~40	1,190	1,070	210	0.2	20~38	1,190	1,250
Stainless steel (SUS304) below 250HB	JC8015 (DH102)	~100	0.2	20~40	1,430	1,290	~100	0.2	20~38	1,430	1,500
		150	0.2	20~40	1,430	1,290	150	0.2	20~38	1,430	1,500
		210	0.2	20~40	1,030	740	210	0.2	20~38	1,030	870
Titanium alloy (Ti-6Al-4V)	DH102	~100	0.2	20~40	400	360	~100	0.2	20~38	400	420
		150	0.2	20~40	400	360	150	0.2	20~38	400	420
		210	0.2	20~40	240	140	210	0.2	20~38	240	170

Note

1. Please adjust cutting conditions according to machine rigidity or work rigidity.
2. In case of chatter occurring, recommended to reduce a_p or rpm and keep feed per tooth.
3. a_p should be reduced when using on low rigidity machine.
4. Use air blow.
5. YPHW-F insert with lower feed is recommended for better surface finish in case chatter occurs.
Please scan QR code for cutting conditions of YPHW-F /-24 for bottom finishing.



QM MAX**MQX/QXP Type**

■ Recommended cutting conditions

● QXP Type (YPHW-15 insert) - Bottom finishing

4

Material	Grade	Tool dia.(mm)									
		40									
		6N					7N				
		ϕ (mm)	a_p (mm)	a_e (mm)	n (min ⁻¹)	V_f (mm/min)	ϕ (mm)	a_p (mm)	a_e (mm)	n (min ⁻¹)	V_f (mm/min)
Carbon steel (S50C, S55C) below 250HB	CX75 (DH102)	~150	0.2	20~40	2,100	3,150	~150	0.2	20~38	2,100	3,680
		200	0.2	20~40	2,100	3,150	200	0.2	20~38	2,100	3,680
		250	0.2	20~40	1,570	1,890	250	0.2	20~38	1,570	2,200
		300	0.2	20~22	1,360	1,640	300	0.2	20~22	1,360	1,900
		350	-	-	-	-	350	-	-	-	-
Tool & die steel (SKD61, SKD11) below 255HB	CX75 (DH102)	~150	0.2	20~40	1,890	2,830	~150	0.2	20~38	1,890	3,300
		200	0.2	20~40	1,890	2,830	200	0.2	20~38	1,890	3,300
		250	0.2	20~40	1,410	1,700	250	0.2	20~38	1,410	1,980
		300	0.2	20~22	1,220	1,470	300	0.2	20~22	1,220	1,710
		350	-	-	-	-	350	-	-	-	-
Mold steel (HPM7, PX5, P20) 30-36 HRC	DH102	~150	0.2	20~40	1,750	2,100	~150	0.2	20~38	1,750	2,450
		200	0.2	20~40	1,750	2,100	200	0.2	20~38	1,750	2,450
		250	0.2	20~40	1,300	1,400	250	0.2	20~38	1,300	1,650
		300	0.2	20~22	1,150	1,150	300	0.2	20~22	1,150	1,350
		350	-	-	-	-	350	-	-	-	-
Mold steel (NAK80, HPM1, P21) 38-43HRC	DH102	~150	0.2	20~40	1,600	1,150	~150	0.2	20~38	1,600	1,350
		200	0.2	20~40	1,600	1,150	200	0.2	20~38	1,600	1,350
		250	0.2	20~40	1,200	720	250	0.2	20~38	1,200	840
		300	0.2	20~22	1,050	630	300	0.2	20~22	1,050	740
		350	-	-	-	-	350	-	-	-	-
Hardened die steel (SKD61, DAC, DHA) 42-52HRC	DH102	~150	0.2	20~40	800	480	~150	0.2	20~38	800	560
		200	0.2	20~40	800	480	200	0.2	20~38	800	560
		250	0.2	20~40	640	380	250	0.2	20~38	640	440
		300	0.2	20~22	400	120	300	0.2	20~22	400	140
		350	-	-	-	-	350	-	-	-	-
Hardened die steel (SKD11, SLD, DC11) 55-62HRC	DH102	~150	0.2	20~40	560	240	~150	0.2	20~38	560	280
		200	0.2	20~40	560	240	200	0.2	20~38	560	280
		250	0.2	20~40	400	120	250	0.2	20~38	400	140
		300	0.2	20~22	400	120	300	0.2	20~22	400	140
		350	-	-	-	-	350	-	-	-	-
Gery & Nodular cast iron (FC, FCD) below 300HB	DH102	~150	0.2	20~40	1,590	1,910	~150	0.2	20~38	1,590	2,230
		200	0.2	20~40	1,590	1,910	200	0.2	20~38	1,590	2,230
		250	0.2	20~40	1,190	1,070	250	0.2	20~38	1,190	1,250
		300	0.2	20~22	1,030	620	300	0.2	20~22	1,030	720
		350	-	-	-	-	350	-	-	-	-
Stainless steel (SUS304) below 250HB	JC8015 (DH102)	~150	0.2	20~40	1,430	1,290	~150	0.2	20~38	1,430	1,500
		200	0.2	20~40	1,430	1,290	200	0.2	20~38	1,430	1,500
		250	0.2	20~40	1,030	740	250	0.2	20~38	1,030	870
		300	0.2	20~22	800	480	300	0.2	20~22	800	560
		350	-	-	-	-	350	-	-	-	-
Titanium alloy (Ti-6Al-4V)	DH102	~150	0.2	20~40	400	360	~150	0.2	20~38	400	420
		200	0.2	20~40	400	360	200	0.2	20~38	400	420
		250	0.2	20~40	240	140	250	0.2	20~22	240	160
		300	0.2	20~22	240	140	300	0.2	20~22	240	160
		350	-	-	-	-	350	-	-	-	-

Note

1. Please adjust cutting conditions according to machine rigidity or work rigidity.
2. In case of chatter occurring, recommended to reduce a_p or rpm and keep feed per tooth.
3. a_p should be reduced when using on low rigidity machine.
4. Use air blow.
5. YPHW-F insert with lower feed is recommended for better surface finish in case chatter occurs.
Please scan QR code for cutting conditions of YPHW-F /-24 for bottom finishing.



QM MAX**MQX/QXP Type**

■ Recommended cutting conditions

● QXP Type (YPHW-15 insert) - Bottom finishing

4

Material	Grade	Tool dia.(mm)									
		50					50/52				
		7N					8N				
ℓ (mm)	a_p (mm)	a_e (mm)	n (min ⁻¹)	V_f (mm/min)	ℓ (mm)	a_p (mm)	a_e (mm)	n (min ⁻¹)	V_f (mm/min)		
Carbon steel (S50C, S55C) below 250HB	CX75 (DH102)	~150	0.2	25~50	1,700	2,970	~150	0.2	25~48	1,700	3,390
		200	0.2	25~50	1,700	2,970	200	0.2	25~48	1,700	3,390
		250	0.2	25~50	1,700	2,700	250	0.2	25~48	1,700	3,080
		300	0.2	25~50	1,280	1,790	300	0.2	25~48	1,280	2,040
		350	0.2	25~28	1,280	1,790	350	0.2	25~28	1,280	2,040
Tool & die steel (SKD61, SKD11) below 255HB	CX75 (DH102)	~150	0.2	25~50	1,530	2,670	~150	0.2	25~48	1,530	3,050
		200	0.2	25~50	1,530	2,670	200	0.2	25~48	1,530	3,050
		250	0.2	25~50	1,530	2,430	250	0.2	25~48	1,530	2,770
		300	0.2	25~50	1,150	1,600	300	0.2	25~48	1,150	1,830
		350	0.2	25~28	1,150	1,600	350	0.2	25~28	1,150	1,830
Mold steel (HPM7, PX5, P20) 30-36 HRC	DH102	~150	0.2	25~50	1,400	1,950	~150	0.2	25~48	1,400	2,200
		200	0.2	25~50	1,400	1,950	200	0.2	25~48	1,400	2,200
		250	0.2	25~50	1,400	1,750	250	0.2	25~48	1,400	2,000
		300	0.2	25~50	1,050	1,250	300	0.2	25~48	1,050	1,400
		350	0.2	25~28	1,050	1,250	350	0.2	25~28	1,050	1,400
Mold steel (NAK80, HPM1, P21) 38-43HRC	DH102	~150	0.2	25~50	1,250	1,050	~150	0.2	25~48	1,250	1,200
		200	0.2	25~50	1,250	1,050	200	0.2	25~48	1,250	1,200
		250	0.2	25~50	1,250	880	250	0.2	25~48	1,250	1,000
		300	0.2	25~50	950	660	300	0.2	25~48	950	750
		350	0.2	25~28	950	660	350	0.2	25~28	950	750
Hardened die steel (SKD61, DAC, DHA) 42-52HRC	DH102	~150	0.2	25~50	510	360	~150	0.2	25~48	510	410
		200	0.2	25~50	510	360	200	0.2	25~48	510	410
		250	0.2	25~50	510	340	250	0.2	25~48	510	390
		300	0.2	25~50	380	270	300	0.2	25~48	380	310
		350	0.2	25~28	380	270	350	0.2	25~28	380	310
Hardened die steel (SKD11, SLD, DC11) 55-62HRC	DH102	~150	0.2	25~50	380	190	~150	0.2	25~48	380	220
		200	0.2	25~50	380	190	200	0.2	25~48	380	220
		250	0.2	25~50	380	160	250	0.2	25~48	380	180
		300	0.2	25~50	320	130	300	0.2	25~48	320	150
		350	0.2	25~28	320	130	350	0.2	25~28	320	150
Grey & Nodular cast iron (FC, FCD) below 300HB	DH102	~150	0.2	25~50	1,270	1,780	~150	0.2	25~48	1,270	2,030
		200	0.2	25~50	1,270	1,780	200	0.2	25~48	1,270	2,030
		250	0.2	25~50	1,270	1,560	250	0.2	25~48	1,270	1,780
		300	0.2	25~50	950	1,000	300	0.2	25~48	950	1,140
		350	0.2	25~28	950	1,000	350	0.2	25~28	950	1,140
Stainless steel (SUS304) below 250HB	JC8015 (DH102)	~150	0.2	25~50	1,150	1,210	~150	0.2	25~48	1,150	1,380
		200	0.2	25~50	1,150	1,210	200	0.2	25~48	1,150	1,380
		250	0.2	25~50	1,150	1,090	250	0.2	25~48	1,150	1,250
		300	0.2	25~50	830	700	300	0.2	25~48	830	800
		350	0.2	25~28	830	700	350	0.2	25~28	830	800
Titanium alloy (Ti-6Al-4V)	DH102	~150	0.2	25~50	320	340	~150	0.2	25~48	320	390
		200	0.2	25~50	320	340	200	0.2	25~48	320	390
		250	0.2	25~50	320	300	250	0.2	25~48	320	340
		300	0.2	25~50	190	160	300	0.2	25~48	190	180
		350	0.2	25~28	190	160	350	0.2	25~28	190	180

Note

1. Please adjust cutting conditions according to machine rigidity or work rigidity.
2. In case of chatter occurring, recommended to reduce a_p or rpm and keep feed per tooth.
3. a_p should be reduced when using on low rigidity machine.
4. Use air blow.
5. YPHW-F insert with lower feed is recommended for better surface finish in case chatter occurs.
Please scan QR code for cutting conditions of YPHW-F /-24 for bottom finishing.



QM MAX**MQX/QXP Type**

■ Recommended cutting conditions

● QXP Type (YPHW-15 insert) - Bottom finishing

4

Material	Grade	Tool dia.(mm)									
		63/66									
		8N									
		ℓ (mm)	a_p (mm)	a_e (mm)	n (min ⁻¹)	V_f (mm/min)					
Carbon steel (S50C, S55C) below 250HB	CX75 (DH102)	~200	0.2	31~63	1,350	2,700					
		250	0.2	31~63	1,350	2,700					
		300	0.2	31~63	1,350	2,450					
		350	0.2	31~63	1,020	1,630					
		400	0.2	31~35	1,020	1,630					
Tool & die steel (SKD61, SKD11) below 255HB	CX75 (DH102)	~200	0.2	31~63	1,210	2,420					
		250	0.2	31~63	1,210	2,420					
		300	0.2	31~63	1,210	2,190					
		350	0.2	31~63	910	1,450					
		400	0.2	31~35	910	1,450					
Mold steel (HPM7, PX5, P20) 30-36 HRC	DH102	~200	0.2	31~63	1,110	1,750					
		250	0.2	31~63	1,110	1,750					
		300	0.2	31~63	1,110	1,580					
		350	0.2	31~63	830	1,110					
		400	0.2	31~35	830	1,110					
Mold steel (NAK80, HPM1, P21) 38-43HRC	DH102	~200	0.2	31~63	1,000	960					
		250	0.2	31~63	1,000	960					
		300	0.2	31~63	1,000	800					
		350	0.2	31~63	750	590					
		400	0.2	31~35	750	590					
Hardened die steel (SKD61, DAC, DHA) 42-52HRC	DH102	~200	0.2	31~63	400	320					
		250	0.2	31~63	400	320					
		300	0.2	31~63	400	300					
		350	0.2	31~63	300	250					
		400	0.2	31~35	300	250					
Hardened die steel (SKD11, SLD, DC11) 55-62HRC	DH102	~200	0.2	31~63	300	170					
		250	0.2	31~63	300	170					
		300	0.2	31~63	300	140					
		350	0.2	31~63	250	120					
		400	0.2	31~35	250	120					
Grey & Nodular cast iron (FC, FCD) below 300HB	DH102	~200	0.2	31~63	1,000	1,600					
		250	0.2	31~63	1,000	1,600					
		300	0.2	31~63	1,000	1,400					
		350	0.2	31~63	750	900					
		400	0.2	31~35	750	900					
Stainless steel (SUS304) below 250HB	JC8015 (DH102)	~200	0.2	31~63	910	1,090					
		250	0.2	31~63	910	1,090					
		300	0.2	31~63	910	990					
		350	0.2	31~63	660	640					
		400	0.2	31~35	660	640					
Titanium alloy (Ti-6Al-4V)	DH102	~200	0.2	31~63	250	300					
		250	0.2	31~63	250	300					
		300	0.2	31~63	250	270					
		350	0.2	31~63	150	140					
		400	0.2	31~35	150	140					

Note

1. Please adjust cutting conditions according to machine rigidity or work rigidity.
2. In case of chatter occurring, recommended to reduce a_p or rpm and keep feed per tooth.
3. a_p should be reduced when using on low rigidity machine.
4. Use air blow.
5. YPHW-F insert with lower feed is recommended for better surface finish in case chatter occurs.
Please scan QR code for cutting conditions of YPHW-F /-24 for bottom finishing.



QM MAX **MQX/QXP Type**

- Recommended cutting conditions
- MQX Type (YPHW100320ZER-24) - Contour milling

5

Material	Grade	Tool dia.(mm)									
		16/17									
		2N									
		ℓ (mm)	ap (mm)	ae (mm)	n (min ⁻¹)	Vf (mm/min)					
Mold steel (NAK80, HPM1, P21) 38-43HRC	JC8015 (DH102)	~70	0.4	<7	4,400	2,200					
		120	0.3	<7	4,400	2,200					
		160	0.2	<7	4,400	2,200					
Hardened die steel (SKD61, DAC, DHA) 42-52HRC	JC8015 (DH102)	~70	0.25	<7	3,200	1,600					
		120	0.2	<7	3,200	1,600					
		160	-	-	-	-					
Hardened die steel (SKD11, SLD, DC11) 55-62HRC	DH102	~70	0.2	<6	2,000	800					
		120	0.15	<6	2,000	800					
		160	-	-	-	-					

Material	Grade	Tool dia.(mm)									
		20					20/21				
		3N					4N				
		ℓ (mm)	ap (mm)	ae (mm)	n (min ⁻¹)	Vf (mm/min)	ℓ (mm)	ap (mm)	ae (mm)	n (min ⁻¹)	Vf (mm/min)
Mold steel (NAK80, HPM1, P21) 38-43HRC	JC8015 (DH102)	~70	0.4	<9	3,500	2,600	~70	0.4	<9	3,500	3,500
		120	0.3	<9	3,500	2,600	120	0.3	<9	3,500	3,500
		190	0.2	<9	3,500	2,600	190	0.2	<9	3,500	3,500
Hardened die steel (SKD61, DAC, DHA) 42-52HRC	JC8015 (DH102)	~70	0.25	<9	2,550	1,900	~70	0.25	<9	2,550	2,550
		120	0.2	<9	2,550	1,900	120	0.2	<9	2,550	2,550
		190	-	-	-	-	190	-	-	-	-
Hardened die steel (SKD11, SLD, DC11) 55-62HRC	DH102	~70	0.2	<7	1,600	960	~70	0.2	<7	1,600	1,280
		120	0.15	<7	1,600	960	120	0.15	<7	1,600	1,280
		190	-	-	-	-	190	-	-	-	-

- Note
1. Please adjust cutting conditions according to machine rigidity or work rigidity.
 2. In case of chatter occurring, recommended to reduce ap or rpm and keep feed per tooth.
 3. ap should be reduced when using on low rigidity machine.
 4. Use air blow.

QM MAX**MQX/QXP Type**

■ Recommended cutting conditions

● MQX Type (YPHW100320ZER-24) - Contour milling

5

Material	Grade	Tool dia.(mm)									
		25/26					25/26/28				
		4N					5N				
		ℓ (mm)	a_p (mm)	a_e (mm)	n (min ⁻¹)	V_f (mm/min)	ℓ (mm)	a_p (mm)	a_e (mm)	n (min ⁻¹)	V_f (mm/min)
Mold steel (NAK80, HPM1, P21) 38-43HRC	JC8015 (DH102)	~90	0.4	<10	2,800	2,800	~90	0.4	<10	2,800	3,500
		140	0.3	<10	2,800	2,800	140	0.3	<10	2,800	3,500
		210	0.2	<10	2,800	2,800	210	0.2	<10	2,800	3,500
Hardened die steel (SKD61, DAC, DHA) 42-52HRC	JC8015 (DH102)	~90	0.25	<10	2,040	2,040	~90	0.25	<10	2,040	2,550
		140	0.2	<10	2,040	2,040	140	0.2	<10	2,040	2,550
		210	-	-	-	-	210	-	-	-	-
Hardened die steel (SKD11, SLD, DC11) 55-62HRC	DH102	~90	0.2	<8	1,270	1,020	~90	0.2	<8	1,270	1,360
		140	0.15	<8	1,270	1,020	140	0.15	<8	1,270	1,360
		210	-	-	-	-	210	-	-	-	-

Material	Grade	Tool dia.(mm)									
		30/32/35					32/35				
		5N					6N				
		ℓ (mm)	a_p (mm)	a_e (mm)	n (min ⁻¹)	V_f (mm/min)	ℓ (mm)	a_p (mm)	a_e (mm)	n (min ⁻¹)	V_f (mm/min)
Mold steel (NAK80, HPM1, P21) 38-43HRC	JC8015 (DH102)	~100	0.4	<13	2,200	2,750	~100	0.4	<13	2,200	3,300
		150	0.3	<13	2,200	2,750	150	0.3	<13	2,200	3,300
		210	0.2	<13	2,200	2,750	210	0.2	<13	2,200	3,300
Hardened die steel (SKD61, DAC, DHA) 42-52HRC	JC8015 (DH102)	~100	0.25	<13	1,600	2,000	~100	0.25	<13	1,600	2,400
		150	0.2	<13	1,600	2,000	150	0.2	<13	1,600	2,400
		210	0.15	<13	1,600	2,000	210	0.15	<13	1,600	2,400
Hardened die steel (SKD11, SLD, DC11) 55-62HRC	DH102	~100	0.2	<10	1,000	1,000	~100	0.2	<10	1,000	1,200
		150	0.15	<10	1,000	1,000	150	0.15	<10	1,000	1,200
		210	0.1	<10	1,000	1,000	210	0.1	<10	1,000	1,200

Note

1. Please adjust cutting conditions according to machine rigidity or work rigidity.
2. In case of chatter occurring, recommended to reduce a_p or rpm and keep feed per tooth.
3. a_p should be reduced when using on low rigidity machine.
4. Use air blow.

QM MAX**MQX/QXP Type**

■ Recommended cutting conditions

● MQX Type (YPHW100320ZER-24) - Contour milling

5

Material	Grade	Tool dia.(mm)									
		40/42					40				
		6N					7N				
		ℓ (mm)	a_p (mm)	a_e (mm)	n (min ⁻¹)	V_f (mm/min)	ℓ (mm)	a_p (mm)	a_e (mm)	n (min ⁻¹)	V_f (mm/min)
Mold steel (NAK80, HPM1, P21) 38-43HRC	JC8015 (DH102)	~100	0.4	<17	1,750	2,620	~100	0.4	<17	1,750	3,060
		150	0.3	<17	1,750	2,620	150	0.3	<17	1,750	3,060
		210	0.2	<17	1,750	2,620	210	0.2	<17	1,750	3,060
Hardened die steel (SKD61, DAC, DHA) 42-52HRC	JC8015 (DH102)	~100	0.25	<17	1,270	1,900	~100	0.25	<17	1,270	2,220
		150	0.2	<17	1,270	1,900	150	0.2	<17	1,270	2,220
		210	0.15	<17	1,270	1,900	210	0.15	<17	1,270	2,220
Hardened die steel (SKD11, SLD, DC11) 55-62HRC	DH102	~100	0.2	<13	800	960	~100	0.2	<13	800	1,120
		150	0.15	<13	800	960	150	0.15	<13	800	1,120
		210	0.1	<13	800	960	210	0.1	<13	800	1,120

Note

1. Please adjust cutting conditions according to machine rigidity or work rigidity.
2. In case of chatter occurring, recommended to reduce a_p or rpm and keep feed per tooth.
3. a_p should be reduced when using on low rigidity machine.
4. Use air blow.

QM MAX**MQX/QXP Type**

■ Recommended cutting conditions

● QXP Type (YPHW100320ZER-24) - Contour milling

5

Material	Grade	Tool dia.(mm)									
		40									
		6N					7N				
φ (mm)	a_p (mm)	a_e (mm)	n (min ⁻¹)	V_f (mm/min)	φ (mm)	a_p (mm)	a_e (mm)	n (min ⁻¹)	V_f (mm/min)		
Mold steel (NAK80, HPM1, P21) 38-43HRC	JC8015 (DH102)	~100	0.4	<17	1,750	2,620	~100	0.4	<17	1,750	3,060
		150	0.3	<17	1,750	2,620	150	0.3	<17	1,750	3,060
		200	0.2	<17	1,750	2,620	200	0.2	<17	1,750	3,060
		250	0.15	<17	1,750	2,620	250	0.15	<17	1,750	3,060
		300	-	-	-	-	300	-	-	-	-
Hardened die steel (SKD61, DAC, DHA) 42-52HRC	JC8015 (DH102)	~100	0.25	<17	1,270	1,900	~100	0.25	<17	1,270	2,220
		150	0.2	<17	1,270	1,900	150	0.2	<17	1,270	2,220
		200	0.15	<17	1,270	1,900	200	0.15	<17	1,270	2,220
		250	0.1	<17	1,270	1,900	250	0.1	<17	1,270	2,220
		300	-	-	-	-	300	-	-	-	-
Hardened die steel (SKD11, SLD, DC11) 55-62HRC	DH102	~100	0.2	<13	800	960	~100	0.2	<13	800	1,120
		150	0.15	<13	800	960	150	0.15	<13	800	1,120
		200	0.1	<13	800	960	200	0.1	<13	800	1,120
		250	-	-	-	-	250	-	-	-	-
		300	-	-	-	-	300	-	-	-	-

Material	Grade	Tool dia.(mm)									
		50					50/52				
		7N					8N				
φ (mm)	a_p (mm)	a_e (mm)	n (min ⁻¹)	V_f (mm/min)	φ (mm)	a_p (mm)	a_e (mm)	n (min ⁻¹)	V_f (mm/min)		
Mold steel (NAK80, HPM1, P21) 38-43HRC	JC8015 (DH102)	~150	0.4	<21	1,400	2,450	~150	0.4	<21	1,400	2,800
		200	0.3	<21	1,400	2,450	200	0.3	<21	1,400	2,800
		250	0.2	<21	1,400	2,450	250	0.2	<21	1,400	2,800
		300	0.15	<21	1,400	2,450	300	0.15	<21	1,400	2,800
		350	-	-	-	-	350	-	-	-	-
Hardened die steel (SKD61, DAC, DHA) 42-52HRC	JC8015 (DH102)	~150	0.25	<21	1,020	1,780	~150	0.25	<21	1,020	2,040
		200	0.2	<21	1,020	1,780	200	0.2	<21	1,020	2,040
		250	0.15	<21	1,020	1,780	250	0.15	<21	1,020	2,040
		300	0.1	<21	1,020	1,780	300	0.1	<21	1,020	2,040
		350	-	-	-	-	350	-	-	-	-
Hardened die steel (SKD11, SLD, DC11) 55-62HRC	DH102	~150	0.2	<17	640	900	~150	0.2	<17	640	1,030
		200	0.15	<17	640	900	200	0.15	<17	640	1,030
		250	0.1	<17	640	900	250	0.1	<17	640	1,030
		300	-	-	-	-	300	-	-	-	-
		350	-	-	-	-	350	-	-	-	-

Note

1. Please adjust cutting conditions according to machine rigidity or work rigidity.
2. In case of chatter occurring, recommended to reduce a_p or rpm and keep feed per tooth.
3. a_p should be reduced when using on low rigidity machine.
4. Use air blow.

QM MAX**MQX/QXP Type**

■ Recommended cutting conditions

● QXP Type (YPHW100320ZER-24) - Contour milling

5

Material	Grade	Tool dia.(mm)									
		63/66					8N				
		ℓ (mm)	a_p (mm)	a_e (mm)	n (min ⁻¹)	V_f (mm/min)					
Mold steel (NAK80, HPM1, P21) 38-43HRC	JC8015 (DH102)	~150	0.4	<26	1,110	2,220					
		200	0.4	<26	1,110	2,220					
		250	0.3	<26	1,110	2,220					
		300	0.2	<26	1,110	2,220					
		350	0.15	<26	1,110	2,220					
Hardened die steel (SKD61, DAC, DHA) 42-52HRC	JC8015 (DH102)	~150	0.25	<26	810	1,620					
		200	0.25	<26	810	1,620					
		250	0.2	<26	810	1,620					
		300	0.15	<26	810	1,620					
		350	0.1	<26	810	1,620					
Hardened die steel (SKD11, SLD, DC11) 55-62HRC	DH102	~150	0.2	<21	500	800					
		200	0.2	<21	500	800					
		250	0.15	<21	500	800					
		300	0.1	<21	500	800					
		350	-	-	-	-					

Note

1. Please adjust cutting conditions according to machine rigidity or work rigidity.
2. In case of chatter occurring, recommended to reduce a_p or rpm and keep feed per tooth.
3. a_p should be reduced when using on low rigidity machine.
4. Use air blow.

QM MAX**MQX/QXP Type**

■ Recommended cutting conditions

● MQX Type (YPHW-F1 CBN insert) - Side finishing

6

Material	Grade	Tool dia.(mm)									
		16 / 17					20				
		2N					3N				
		ℓ (mm)	a_p (mm)	a_e (mm)	n (min ⁻¹)	V_f (mm/min)	ℓ (mm)	a_p (mm)	a_e (mm)	n (min ⁻¹)	V_f (mm/min)
Hardened die steel (SKD61, DAC, DHA) 42-52HRC	JBN795	~80	≤ 1.2	<0.1	8,950	1,430	~100	≤ 1.2	<0.1	7,160	1,720
		120	≤ 1.0	<0.1	7,960	1,110	150	≤ 1.0	<0.1	6,370	1,340
		160	-	-	-	-	190	-	-	-	-
Hardened die steel (SKD11, SLD, DC11) 55-62HRC	JBN795	~80	≤ 1.0	<0.1	7,960	1,270	~100	≤ 1.0	<0.1	6,370	1,530
		120	≤ 0.8	<0.1	5,970	720	150	≤ 0.8	<0.1	4,770	860
		160	-	-	-	-	190	-	-	-	-
Grey cast iron (FC) below 300HB	JBN795	~80	≤ 1.5	<0.1	14,900	4,020	~100	≤ 1.5	<0.1	11,900	4,820
		120	≤ 1.0	<0.1	14,900	3,580	150	≤ 1.0	<0.1	11,900	4,280
		160	≤ 0.7	<0.1	14,900	2,980	190	≤ 0.7	<0.1	11,900	3,570
Nodular cast iron (FCD) below 300HB	JBN795	~80	≤ 1.5	<0.1	13,900	3,750	~100	≤ 1.5	<0.1	11,100	4,500
		120	≤ 1.0	<0.1	13,900	3,340	150	≤ 1.0	<0.1	11,100	4,000
		160	≤ 0.7	<0.1	13,900	2,780	190	≤ 0.7	<0.1	11,100	3,330

Material	Grade	Tool dia.(mm)									
		20 / 21									
		4N									
		ℓ (mm)	a_p (mm)	a_e (mm)	n (min ⁻¹)	V_f (mm/min)					
Hardened die steel (SKD61, DAC, DHA) 42-52HRC	JBN795	~100	≤ 1.2	<0.1	7,160	2,290					
		150	≤ 1.0	<0.1	6,370	1,780					
		190	-	-	-	-					
Hardened die steel (SKD11, SLD, DC11) 55-62HRC	JBN795	~100	≤ 1.0	<0.1	6,370	2,040					
		150	≤ 0.8	<0.1	4,770	1,140					
		190	-	-	-	-					
Grey cast iron (FC) below 300HB	JBN795	~100	≤ 1.5	<0.1	11,900	6,430					
		150	≤ 1.0	<0.1	11,900	5,710					
		190	≤ 0.7	<0.1	11,900	4,760					
Nodular cast iron (FCD) below 300HB	JBN795	~100	≤ 1.5	<0.1	11,100	6,000					
		150	≤ 1.0	<0.1	11,100	5,330					
		190	≤ 0.7	<0.1	11,100	4,440					

Note

1. Please adjust cutting conditions according to machine rigidity or work rigidity.
2. In case of chatter occurring, recommended to reduce a_p or rpm and keep feed per tooth.
3. a_p should be reduced when using on low rigidity machine.
4. Use air blow.
5. Please scan QR code for cutting conditions of YPHW-F1(CBN)insert for Vertical side finishing or bottom finishing.



QM MAX **MQX/QXP Type**

- Recommended cutting conditions
- MQX Type (YPHW-F1 CBN insert) - Side finishing

6

Material	Grade	Tool dia.(mm)									
		25 / 26					25 / 26 / 28				
		4N					5N				
		ℓ (mm)	a_p (mm)	a_e (mm)	n (min ⁻¹)	V_f (mm/min)	ℓ (mm)	a_p (mm)	a_e (mm)	n (min ⁻¹)	V_f (mm/min)
Hardened die steel (SKD61, DAC, DHA) 42-52HRC	JBN795	~120	≤1.2	<0.1	5,730	1,830	~120	≤1.2	<0.1	5,730	2,290
		190	≤1.0	<0.1	5,090	1,430	190	≤1.0	<0.1	5,090	1,780
		235	-	-	-	-	235	-	-	-	-
Hardened die steel (SKD11, SLD, DC11) 55-62HRC	JBN795	~120	≤1.0	<0.1	5,090	1,630	~120	≤1.0	<0.1	5,090	2,040
		190	≤0.8	<0.1	3,820	920	190	≤0.8	<0.1	3,820	1,150
		235	-	-	-	-	235	-	-	-	-
Grey cast iron (FC) below 300HB	JBN795	~120	≤1.5	<0.1	9,550	5,160	~120	≤1.5	<0.1	9,550	6,450
		190	≤1.0	<0.1	9,550	4,580	190	≤1.0	<0.1	9,550	5,730
		235	≤0.7	<0.1	9,550	3,820	235	≤0.7	<0.1	9,550	4,780
Nodular cast iron (FCD) below 300HB	JBN795	~120	≤1.5	<0.1	8,910	4,810	~120	≤1.5	<0.1	8,910	6,010
		190	≤1.0	<0.1	8,910	4,280	190	≤1.0	<0.1	8,910	5,350
		235	≤0.7	<0.1	8,910	3,560	235	≤0.7	<0.1	8,910	4,460

Material	Grade	Tool dia.(mm)									
		30 / 32 / 35					32 / 35				
		5N					6N				
		ℓ (mm)	a_p (mm)	a_e (mm)	n (min ⁻¹)	V_f (mm/min)	ℓ (mm)	a_p (mm)	a_e (mm)	n (min ⁻¹)	V_f (mm/min)
Hardened die steel (SKD61, DAC, DHA) 42-52HRC	JBN795	~160	≤1.2	<0.1	4,480	1,790	~160	≤1.2	<0.1	4,480	2,150
		240	≤1.0	<0.1	3,980	1,390	240	≤1.0	<0.1	3,980	1,670
		290	-	-	-	-	290	-	-	-	-
Hardened die steel (SKD11, SLD, DC11) 55-62HRC	JBN795	~160	≤1.0	<0.1	3,980	1,590	~160	≤1.0	<0.1	3,980	1,910
		240	≤0.8	<0.1	2,980	900	240	≤0.8	<0.1	2,980	1,070
		290	-	-	-	-	290	-	-	-	-
Grey cast iron (FC) below 300HB	JBN795	~160	≤1.5	<0.1	7,460	5,040	~160	≤1.5	<0.1	7,460	6,040
		240	≤1.0	<0.1	7,460	4,480	240	≤1.0	<0.1	7,460	5,370
		290	≤0.7	<0.1	7,460	3,730	290	≤0.7	<0.1	7,460	4,480
Nodular cast iron (FCD) below 300HB	JBN795	~160	≤1.5	<0.1	6,960	4,700	~160	≤1.5	<0.1	6,960	5,640
		240	≤1.0	<0.1	6,960	4,180	240	≤1.0	<0.1	6,960	5,010
		290	≤0.7	<0.1	6,960	3,480	290	≤0.7	<0.1	6,960	4,180

Note

1. Please adjust cutting conditions according to machine rigidity or work rigidity.
2. In case of chatter occurring, recommended to reduce a_p or rpm and keep feed per tooth.
3. a_p should be reduced when using on low rigidity machine.
4. Use air blow.
5. Please scan QR code for cutting conditions of YPHW-F1(CBN)insert for Vertical side finishing or bottom finishing.



QM MAX**MQX/QXP Type**

■ Recommended cutting conditions

● MQX Type (YPHW-F1 CBN insert) - Side finishing

6

Material	Grade	Tool dia.(mm)									
		40 / 42					40				
		6N					7N				
		ℓ (mm)	a_p (mm)	a_e (mm)	n (min ⁻¹)	V_f (mm/min)	ℓ (mm)	a_p (mm)	a_e (mm)	n (min ⁻¹)	V_f (mm/min)
Hardened die steel (SKD61, DAC, DHA) 42-52HRC	JBN795	~160	≤ 1.2	<0.1	3,580	1,720	~160	≤ 1.2	<0.1	3,580	2,000
		240	≤ 1.0	<0.1	3,180	1,340	240	≤ 1.0	<0.1	3,180	1,560
		290	-	-	-	-	290	-	-	-	-
Hardened die steel (SKD11, SLD, DC11) 55-62HRC	JBN795	~160	≤ 1.0	<0.1	3,180	1,530	~160	≤ 1.0	<0.1	3,180	1,780
		240	≤ 0.8	<0.1	2,390	860	240	≤ 0.8	<0.1	2,390	1,000
		290	-	-	-	-	290	-	-	-	-
Grey cast iron (FC) below 300HB	JBN795	~160	≤ 1.5	<0.1	5,970	4,840	~160	≤ 1.5	<0.1	5,970	5,640
		240	≤ 1.0	<0.1	5,970	4,300	240	≤ 1.0	<0.1	5,970	5,010
		290	≤ 0.7	<0.1	5,970	3,580	290	≤ 0.7	<0.1	5,970	4,180
Nodular cast iron (FCD) below 300HB	JBN795	~160	≤ 1.5	<0.1	5,570	4,510	~160	≤ 1.5	<0.1	5,570	5,260
		240	≤ 1.0	<0.1	5,570	4,010	240	≤ 1.0	<0.1	5,570	4,680
		290	≤ 0.7	<0.1	5,570	3,340	290	≤ 0.7	<0.1	5,570	3,900

Note

1. Please adjust cutting conditions according to machine rigidity or work rigidity.
2. In case of chatter occurring, recommended to reduce a_p or rpm and keep feed per tooth.
3. a_p should be reduced when using on low rigidity machine.
4. Use air blow.
5. Please scan QR code for cutting conditions of YPHW-F1(CBN)insert for Vertical side finishing or bottom finishing.



QM MAX

MQX/QXP Type

■ Recommended cutting conditions

● QXP type (YPHW-F1 CBN insert) - Side finishing

6

Material	Grade	Tool dia.(mm)									
		40					7N				
		ℓ (mm)	a_p (mm)	a_e (mm)	n (min ⁻¹)	V_f (mm/min)	ℓ (mm)	a_p (mm)	a_e (mm)	n (min ⁻¹)	V_f (mm/min)
Hardened die steel (SKD61, DAC, DHA) 42-52HRC	JBN795	~150	≤1.2	<0.1	3,580	1,720	~150	≤1.2	<0.1	3,580	2,000
		200	≤1.0	<0.1	3,180	1,340	200	≤1.0	<0.1	3,180	1,560
		250	-	-	-	-	250	-	-	-	-
		300	-	-	-	-	300	-	-	-	-
		350	-	-	-	-	350	-	-	-	-
Hardened die steel (SKD11, SLD, DC11) 55-62HRC	JBN795	~150	≤1.0	<0.1	3,180	1,530	~150	≤1.0	<0.1	3,180	1,780
		200	≤0.8	<0.1	2,390	860	200	≤0.8	<0.1	2,390	1,000
		250	-	-	-	-	250	-	-	-	-
		300	-	-	-	-	300	-	-	-	-
		350	-	-	-	-	350	-	-	-	-
Grey cast iron (FC) below 300HB	JBN795	~150	≤1.5	<0.1	5,970	4,840	~150	≤1.5	<0.1	5,970	5,640
		200	≤1.0	<0.1	5,970	4,300	200	≤1.0	<0.1	5,970	5,010
		250	≤0.7	<0.1	5,970	3,580	250	≤0.7	<0.1	5,970	4,180
		300	≤0.7	<0.1	5,970	3,580	300	≤0.7	<0.1	5,970	4,180
		350	-	-	-	-	350	-	-	-	-
Nodular cast iron (FCD) below 300HB	JBN795	~150	≤1.5	<0.1	5,570	4,510	~150	≤1.5	<0.1	5,570	5,260
		200	≤1.0	<0.1	5,570	4,010	200	≤1.0	<0.1	5,570	4,680
		250	≤0.7	<0.1	5,570	3,340	250	≤0.7	<0.1	5,570	3,900
		300	≤0.7	<0.1	5,570	3,340	300	≤0.7	<0.1	5,570	3,900
		350	-	-	-	-	350	-	-	-	-

Material	Grade	Tool dia.(mm)									
		50					50/52				
		ℓ (mm)	a_p (mm)	a_e (mm)	n (min ⁻¹)	V_f (mm/min)	ℓ (mm)	a_p (mm)	a_e (mm)	n (min ⁻¹)	V_f (mm/min)
Hardened die steel (SKD61, DAC, DHA) 42-52HRC	JBN795	~150	≤1.2	<0.1	2,860	1,600	~150	≤1.2	<0.1	2,860	1,830
		200	≤1.2	<0.1	2,860	1,600	200	≤1.2	<0.1	2,860	1,830
		250	≤1.0	<0.1	2,550	1,250	250	≤1.0	<0.1	2,550	1,430
		300	≤1.0	<0.1	2,550	1,250	300	≤1.0	<0.1	2,550	1,430
		350	-	-	-	-	350	-	-	-	-
Hardened die steel (SKD11, SLD, DC11) 55-62HRC	JBN795	~150	≤1.0	<0.1	2,550	1,430	~150	≤1.0	<0.1	2,550	1,630
		200	≤1.0	<0.1	2,550	1,430	200	≤1.0	<0.1	2,550	1,630
		250	≤0.8	<0.1	1,910	800	250	≤0.8	<0.1	1,910	920
		300	≤0.8	<0.1	1,910	800	300	≤0.8	<0.1	1,910	920
		350	-	-	-	-	350	-	-	-	-
Grey cast iron (FC) below 300HB	JBN795	~150	≤1.5	<0.1	4,780	4,520	~150	≤1.5	<0.1	4,780	5,160
		200	≤1.5	<0.1	4,780	4,520	200	≤1.5	<0.1	4,780	5,160
		250	≤1.0	<0.1	4,780	4,020	250	≤1.0	<0.1	4,780	4,590
		300	≤1.0	<0.1	4,780	4,020	300	≤1.0	<0.1	4,780	4,590
		350	≤0.7	<0.1	4,780	3,350	350	≤0.7	<0.1	4,780	3,820
Nodular cast iron (FCD) below 300HB	JBN795	~150	≤1.5	<0.1	4,460	4,210	~150	≤1.5	<0.1	4,460	4,820
		200	≤1.5	<0.1	4,460	4,210	200	≤1.5	<0.1	4,460	4,820
		250	≤1.0	<0.1	4,460	3,750	250	≤1.0	<0.1	4,460	4,280
		300	≤1.0	<0.1	4,460	3,750	300	≤1.0	<0.1	4,460	4,280
		350	≤0.7	<0.1	4,460	3,120	350	≤0.7	<0.1	4,460	3,570

Note

1. Please adjust cutting conditions according to machine rigidity or work rigidity.
2. In case of chatter occurring, recommended to reduce a_p or rpm and keep feed per tooth.
3. a_p should be reduced when using on low rigidity machine.
4. Use air blow.
5. Please scan QR code for cutting conditions of YPHW-F1(CBN)insert for Vertical side finishing or bottom finishing.



QM MAX**MQX/QXP Type**

■ Recommended cutting conditions

● QXP type (YPHW-F1 CBN insert) - Side finishing

6

Material	Grade	Tool dia.(mm)									
		63/66									
		l (mm)	a_p (mm)	a_e (mm)	n (min ⁻¹)	V_f (mm/min)					
8N											
Hardened die steel (SKD61, DAC, DHA) 42-52HRC	JBN795	~200	≤ 1.2	< 0.1	2,270	1,450					
		250	≤ 1.2	< 0.1	2,270	1,450					
		300	≤ 1.0	< 0.1	2,020	1,130					
		350	≤ 1.0	< 0.1	2,020	1,130					
		400	-	-	-	-					
Hardened die steel (SKD11, SLD, DC11) 55-62HRC	JBN795	~200	≤ 1.0	< 0.1	2,020	1,290					
		250	≤ 1.0	< 0.1	2,020	1,290					
		300	≤ 0.8	< 0.1	1,520	730					
		350	≤ 0.8	< 0.1	1,520	730					
		400	-	-	-	-					
Grey cast iron (FC) below 300HB	JBN795	~200	≤ 1.5	< 0.1	3,790	4,090					
		250	≤ 1.5	< 0.1	3,790	4,090					
		300	≤ 1.0	< 0.1	3,790	3,640					
		350	≤ 1.0	< 0.1	3,790	3,640					
		400	≤ 0.7	< 0.1	3,790	3,030					
Nodular cast iron (FCD) below 300HB	JBN795	~200	≤ 1.5	< 0.1	3,540	3,820					
		250	≤ 1.5	< 0.1	3,540	3,820					
		300	≤ 1.0	< 0.1	3,540	3,400					
		350	≤ 1.0	< 0.1	3,540	3,400					
		400	≤ 0.7	< 0.1	3,540	2,830					

Note

1. Please adjust cutting conditions according to machine rigidity or work rigidity.
2. In case of chatter occurring, recommended to reduce a_p or rpm and keep feed per tooth.
3. a_p should be reduced when using on low rigidity machine.
4. Use air blow.
5. Please scan QR code for cutting conditions of YPHW-F1(CBN)insert for Vertical side finishing or bottom finishing.



QM MILL **MPM/PME Type**



Low cutting force geometry

- Unique 3D geometry insert provides stable cutting and less power consumption.
- BT30 Capable of running on low horse power & compact machines.

Multi - flutes specification

High speed and high efficient machining.

Vibration free

Control vibration with combination of MSN carbide shank holder for longer tool life.

Low cutting force geometry High feed machining with Multi-flutes specification

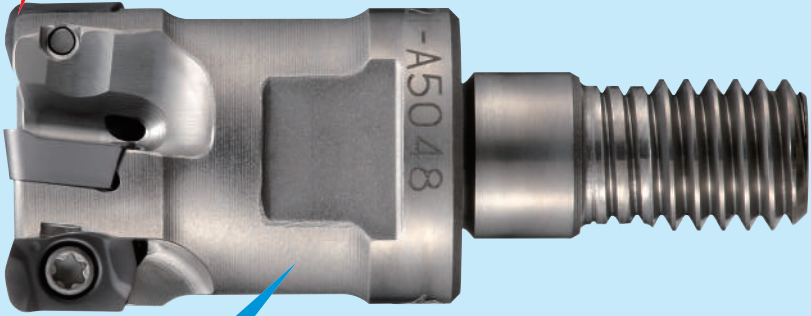
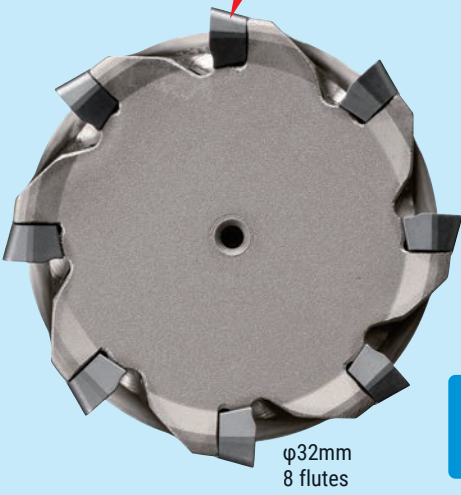

Adopted G-Body Possible to use even for finishing applications

Insert Line-Up

A variety of inserts all fit into the same body.

High feed insert



EOMT0602...ZER (R1.0, 2.0)

High feed insert for unfavorable conditions



EOMW060210ZER

Shoulder insert



ZOMT0602...ZER-PL (R0.2,0.4,0.8)

For high hardened steel

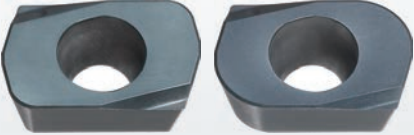

EOHW0602...ZTR (R1.0, 2.0)

"Mirror Insert" for finishing side & bottom face



YOHW0602...ZER-12

QM MILL **MPM/PME Type**

■ Endmill Shank Type

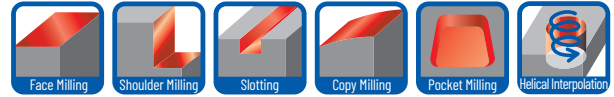

■ PME type (Through coolant hole)

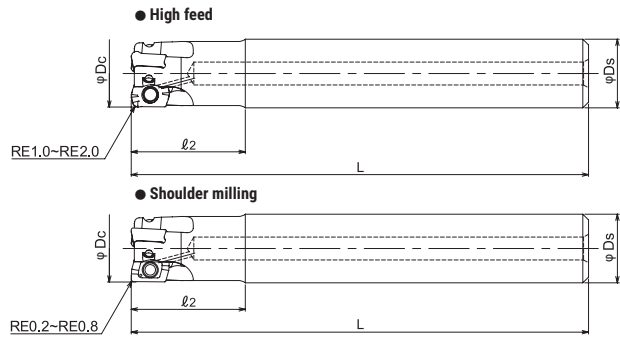

■ PME-LS type (No coolant hole)

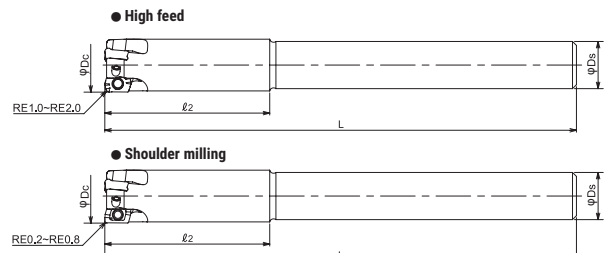

Type	Cat.No.	Stock	No. of inserts	Dimensions (mm)					Inserts	
				φDc	ℓ2	L	φD1	φDs		
Standard	PME2010S10	●	2	10	20	80	9.3	10	EO**0602**Z*R; ZOMT0602**ZER; YOHW0602**ZER-12	
	PME3012S12	●	3	12			10.3	12		
	PME3014S12	●		14			11.2			
Long shank	PME2011S10-LS	●	2	11	33	120	12.2	10		
	PME3013S12-LS	●	3	13			39	13.15		12
	PME3014S12-LS	●		14			42			

Screw	Torque(N.m)	Wrench
DSW-1840H	0.4	A-06

QM MILL **MPM/PME Type**

■ **Modular Head Type**

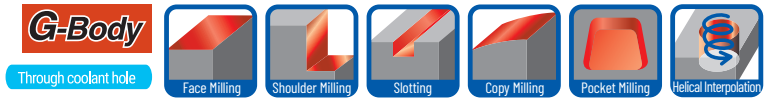

● **High feed**

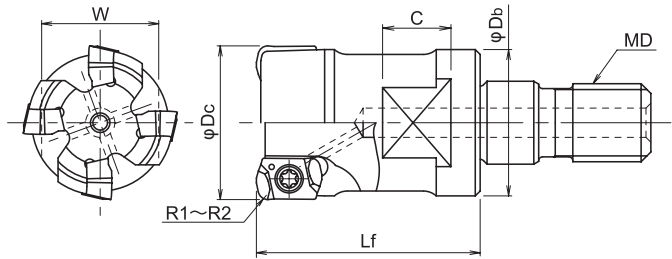

● **Shoulder milling**

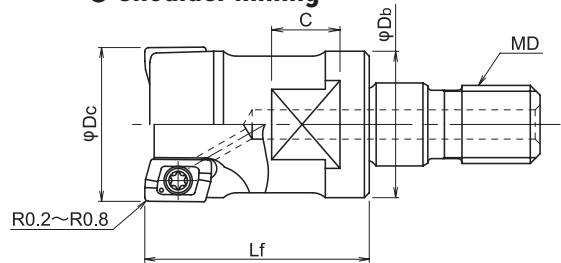

Cat.No.	Stock	No. of inserts	Dimensions (mm)						Inserts
			φDc	Lf	φDb	MD	C	W	
MPM-2010-M6	●	2	10	18	9.5	M6	6.5	8	EO**0602**Z*R; ZOMT0602**ZER; YOHWO602**ZER-12
MPM-2011-M6	●		11		9.7	M6			
MPM-3012-M6	●	3	12	20	11.2	M6			
MPM-3013-M6	●		13		11.5	M6			
MPM-3015-M8	●	15	23	14	M8	8	12		
MPM-4016-M8	●	16		M8					
MPM-4017-M8	●	17		M8					
MPM-4018-M8	●	18		M8					
MPM-5020-M10	●	5	20	30	19	M10	9	14	
MPM-5021-M10	●		21			M10			
MPM-6025-M12	●	6	25	35	23.6	M12	10	17	
MPM-7030-M16	●	7	30	43	29	M16	12	22	
MPM-8032-M16	●	8	32			M16			

Screw	Torque(N.m)	Wrench
DSW-1840H	0.4	A-06

QM MILL **MPM/PME Type**

■ **Insert**

High feed insert

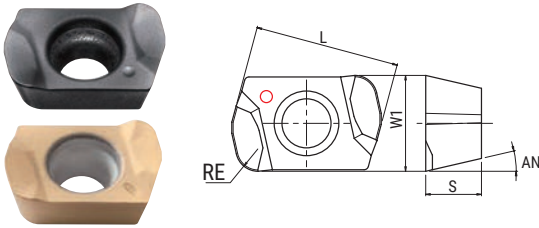

For high hardened steel

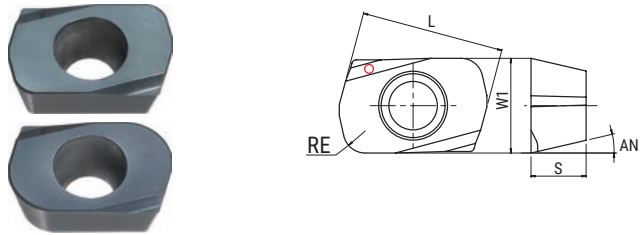

High feed insert for unfavorable conditions

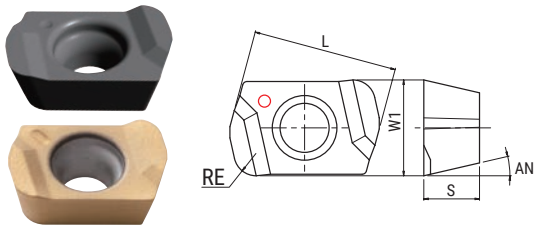

Shoulder insert

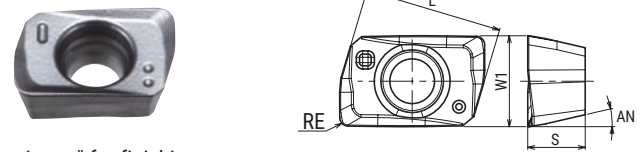

"Mirror Insert" for finishing side & bottom face

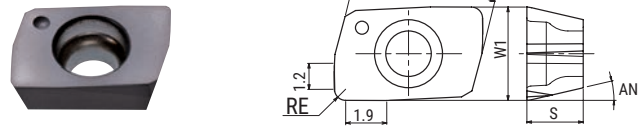

Type	Cat.No.	Tolerance	PVD Coating						Dimensions (mm)				
			DH102	DS118	DS150	JC7560	JC8015	JC8050	JC8118	RE	L	W1	S
High feed insert	EOMT060210ZER	M		●	●	●		●	●	1	6.5	2.5	13°
	EOMT060220ZER			●	●			●	●	2			
High feed insert for unfavorable conditions	EOMW060210ZER				●			●	●	1			
For high hardened steel	EOHW060210ZTR	H	●						●				
	EOHW060220ZTR		●						●	2			
shoulder insert	ZOMT060202ZER-PL	M						●	●	0.2	6.62	4.3	2.7
	ZOMT060204ZER-PL							●	●	0.4			
	ZOMT060208ZER-PL							●	●	0.8			
"Mirror Insert" for finishing side & bottom face	YOHW060203ZER-12	H	●				●			0.3	6.5	2.6	
	YOHW060205ZER-12		●				●			0.5			
	YOHW060208ZER-12		●				●			0.8			

GRADE MARKINGS

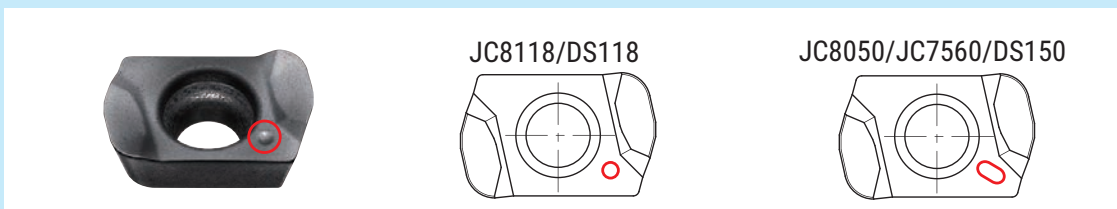

■ **MAGNETIZER**



- Magnetizing and demagnetizing a wrench can easily be done by inserting the tip into the magnetizer and rubbing lightly.
- Do not use in the vicinity of the equipment that can be influenced with magnetism.

Cat.No.	Stock
MAGNETISER	●

QM MILL **MPM/PME Type**

■ Insert selection guide

Material	Carbon steel (S50C, S55C) below 250HB						Tool & die steel # (SKD61, SKD11) below 255HB						
	Cat.No. \ Grade	JC8118	JC8050	JC7560	DH102	DS118	DS150	JC8118	JC8050	JC7560	DH102	DS118	DS150
EOMT0602*0ZER	☆	☆	☆				☆	☆	☆				
EOMW060210ZER	○	○	◎				○	○	◎				
EOHW0602*0ZTR													

Material	Mold steel (HPM7, PX5, KPM30) 30-36HRC						Mold steel (NAK80, HPM1) 38-43HRC						
	Cat.No. \ Grade	JC8118	JC8050	JC7560	DH102	DS118	DS150	JC8118	JC8050	JC7560	DH102	DS118	DS150
EOMT0602*0ZER	☆	☆	☆				☆	☆					
EOMW060210ZER	○	○	◎				◎	○					
EOHW0602*0ZTR													

Material	Hardened die steel (SKD61, DAC, DHA) 42-52HRC						Hardened die steel (SKD11, SLD, DC11) 55-62HRC						
	Cat.No. \ Grade	JC8118	JC8050	JC7560	DH102	DS118	DS150	JC8118	JC8050	JC7560	DH102	DS118	DS150
EOMT0602*0ZER	☆						x	x					
EOMW060210ZER	○	●					○						
EOHW0602*0ZTR	◎						●			◎			

Material	Cast iron (FC, FCD) below 300HB						Stainless steel (SUS304) below 250HB						
	Cat.No. \ Grade	JC8118	JC8050	JC7560	DH102	DS118	DS150	JC8118	JC8050	JC7560	DH102	DS118	DS150
EOMT0602*0ZER	○							◎	○				
EOMW060210ZER	◎		●					●					
EOHW0602*0ZTR													

Material	Titanium alloy (Ti-6Al-4V)						Heat resistant alloy (INCO718)						
	Cat.No. \ Grade	JC8118	JC8050	JC7560	DH102	DS118	DS150	JC8118	JC8050	JC7560	DH102	DS118	DS150
EOMT0602*0ZER	○	○	◎		○	◎	◎	○	○			○	○
EOMW060210ZER			●					●					
EOHW0602*0ZTR													

◎: First choice ○: For general milling ●: For unstable milling ☆: For light cutting force x: Not recommended

QM MILL **MPM/PME Type**

■ Definition of corner shape for programming

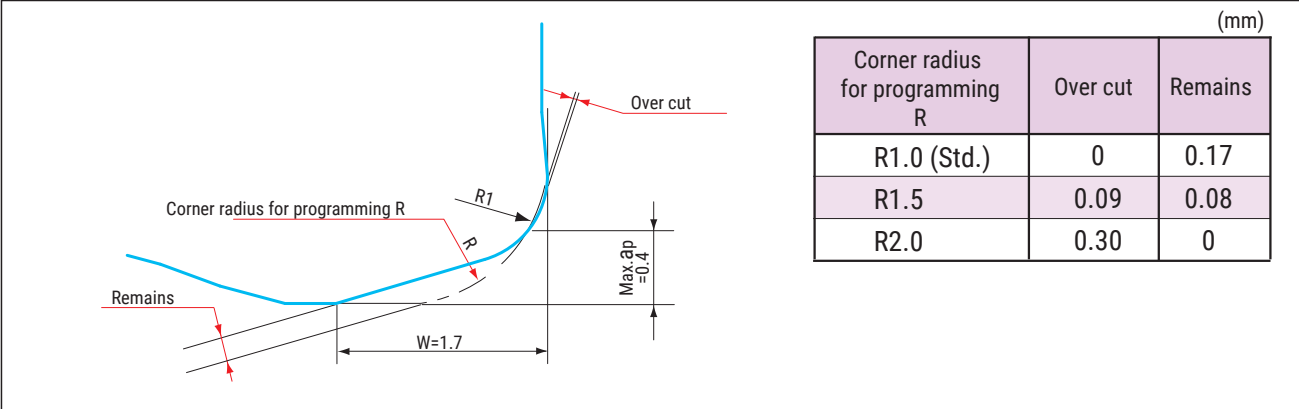

■ Recommended Data for Profile Milling

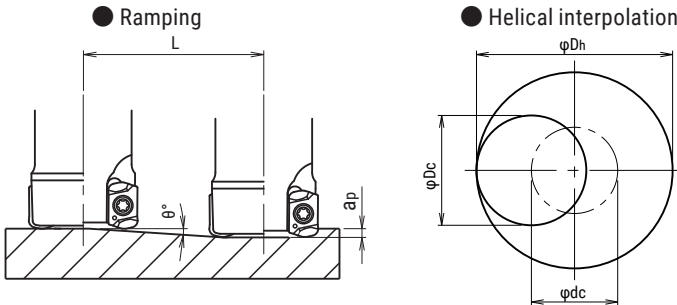

- Calculation of tool pass dia.
 $\varphi_{dc} = \varphi_{Dh} - \varphi_{Dc}$
 Tool pass dia. Bore dia. Tool Dia.
- Depth of cut per one circuit should not exceed max. depth of cut A_p
- Down cutting is recommended, tool pass rotation should be counterclockwise

- In case of ramping and helical interpolation, apply 70% or less feed (V_f) from standard cutting condition table
- In case of drilling, apply 50% or less Z axis feed (F) from standard cutting condition table
- Long consecutive chips may result in case of drilling, confirm safe operating conditions

Cat.No.	Tool dia. (mm)	Effective cutting dia. (mm)	Max.depth of cut: A_p (mm)	Ramping		Helical interpolation	
				Max. ramping angle θ	Max. depth of cut (A_p) Total cutting length L(mm)	Min. Bore dia. (mm)	Max. Bore dia. (mm)
MPM-2010-M6	10	6.6	0.3	2°18'	7.5	15	18
MPM-2011-M6	11	7.6	0.3	1°54'	9	17	20
MPM-3012-M6	12	8.5	0.3	1°36'	10.7	19	22
MPM-3013-M6	13	9.5	0.3	1°24'	12.3	21	24
MPM-3015-M8	15	11.5	0.4	1°12'	19.1	25	28
MPM-4016-M8	16	12.5	0.4	1°	22.9	27	30
MPM-4017-M8	17	13.5	0.4	0°54'	25.5	29	32
MPM-4018-M8	18	14.5	0.4	0°51'	27.0	31	34
MPM-5020-M10	20	16.5	0.4	0°45'	30.6	35	38
MPM-5021-M10	21	17.5	0.4	0°42'	32.7	37	40
MPM-6025-M12	25	21.5	0.4	0°30'	45.8	45	48
MPM-7030-M16	30	26.5	0.4	0°27'	50.9	55	58
MPM-8032-M16	32	28.5	0.4	0°24'	57.3	59	62
PME2010S10	10	6.6	0.3	2°18'	7.5	15	18
PME2011S10-LS	11	7.6	0.3	1°54'	9	17	20
PME3012S12	12	8.5	0.3	1°36'	10.7	19	22
PME3013S12-LS	13	9.5	0.3	1°24'	12.3	21	24
PME3014S12 (-LS)	14	10.5	0.3	1°18'	13.2	23	26

QM MILL**MPM Type**

■ Recommended cutting conditions

● MPM type (EOMT/W insert)

①

Material	Grade	Tool dia.(mm)														
		10/11					12/13/14/15					16/17/18				
		2N					3N					4N				
		ℓ (mm)	ap (mm)	ae (mm)	n (min ⁻¹)	Vf (mm/min)	ℓ (mm)	ap (mm)	ae (mm)	n (min ⁻¹)	Vf (mm/min)	ℓ (mm)	ap (mm)	ae (mm)	n (min ⁻¹)	Vf (mm/min)
Carbon steel (S50C, S55C) below 250HB	JC7560	50	0.3	~6	3,820	4,580	60	0.3	~8	3,180	5,720	70	0.4	~12	2,390	8,600
	(JC8050)	75	0.25	~6	3,440	3,720	80	0.25	~8	2,860	4,630	120	0.3	~12	2,150	6,970
	(JC8118)	100	0.2	~5	3,060	2,940	110	0.2	~7	2,540	3,660	160	0.25	~12	1,910	5,500
Tool & die steel (SKD61, SKD11) below 255HB	JC7560	50	0.3	~6	3,500	4,200	60	0.3	~8	2,920	5,260	70	0.4	~12	2,190	7,880
	(JC8050)	75	0.2	~6	3,150	3,400	80	0.2	~8	2,630	4,260	120	0.3	~12	1,970	6,380
	(JC8118)	100	0.15	~5	2,800	2,690	110	0.15	~7	2,340	3,370	160	0.25	~12	1,750	4,900
Mold steel (HPM7, PX5, P20) 30-36 HRC	JC8118	50	0.3	~6	3,500	4,200	60	0.3	~8	2,920	5,260	70	0.4	~12	2,190	7,880
	(JC7560)	75	0.25	~6	3,150	3,400	80	0.25	~8	2,630	4,260	120	0.3	~12	1,970	6,380
	(JC8050)	100	0.2	~5	2,800	2,690	110	0.2	~7	2,340	3,370	160	0.25	~12	1,750	4,900
Mold steel (NAK80, HPM1, P21) 38-43HRC	JC8118	50	0.3	~6	2,860	3,150	60	0.3	~8	2,390	3,940	70	0.3	~12	1,790	5,010
	(JC8050)	75	0.25	~6	2,570	2,540	80	0.25	~8	2,150	3,190	120	0.25	~12	1,610	4,060
		100	0.2	~5	2,290	2,010	110	0.2	~7	1,910	2,520	160	0.2	~12	1,430	3,200
Hardened die steel (SKD61, DAC, DHA) 42-52HRC	JC8118	50	0.25	~6	2,230	2,230	60	0.25	~8	1,860	2,790	70	0.3	~12	1,390	3,340
	(JC8050)	75	0.15	~6	2,010	1,810	80	0.15	~8	1,670	2,250	120	0.2	~12	1,250	2,700
		100	-	-	-	-	110	-	-	-	-	160	-	-	-	-
Hardened die steel (SKD11, SL, DC11) 55-62HRC	JC8118	50	0.1	~6	950	470	60	0.1	~8	800	600	70	0.15	~12	600	600
	EOMW	75	-	-	-	-	80	-	-	-	-	120	0.1	~12	540	490
	Type	100	-	-	-	-	110	-	-	-	-	160	-	-	-	-
Grey & Nodular cast iron (FC, FCD) below 300HB	JC8118	50	0.3	~6	4,780	5,740	60	0.3	~8	3,980	7,160	70	0.4	~12	2,980	10,730
	(JC7560)	75	0.25	~6	4,300	4,640	80	0.25	~8	3,580	5,800	120	0.35	~12	2,680	8,680
		100	0.2	~6	3,820	3,670	110	0.2	~8	3,180	4,580	160	0.3	~12	2,380	6,850
Stainless steel (SUS304) below 250HB	JC8050	50	0.3	~6	3,820	4,580	60	0.3	~8	3,180	5,720	70	0.4	~12	2,390	8,600
	(JC7560)	75	0.2	~6	3,440	3,720	80	0.2	~8	2,860	4,630	120	0.3	~12	2,150	6,880
		100	0.15	~5	3,060	2,940	110	0.15	~7	2,540	3,660	160	0.25	~12	1,910	5,350
Titanium alloy (Ti-6Al-4V)	JC7560	50	0.3	~6	1,910	1,910	60	0.3	~8	1,590	2,380	70	0.3	~12	1,190	2,380
	DS150	75	0.2	~6	1,720	1,550	80	0.2	~8	1,430	1,930	120	0.25	~12	1,070	1,930
	(JC8118) (DS118) (JC8050)	100	0.15	~5	1,530	1,220	110	0.15	~7	1,270	1,520	160	0.2	~12	950	1,520
Heat resistant alloy (INCO718)	JC8118	50	0.3	~6	950	760	60	0.3	~8	800	960	70	0.3	~12	600	960
	DS118	75	0.2	~6	850	760	80	0.2	~8	720	780	120	0.25	~12	540	780
	(JC7560) (DS150) (JC8050)	100	0.15	~5	760	610	110	0.15	~7	640	610	160	0.2	~12	480	610

Note

1. Please adjust cutting conditions according to machine rigidity or work rigidity.
2. In case of chatter occurring, recommended to reduce ap or rpm and keep feed per tooth.
3. ap should be reduced when using on low rigidity machine.
4. Use air blow.

QM MILL**MPM Type**

■ Recommended cutting conditions

● MPM type (EOMT/W insert)

1

Material	Grade	Tool dia.(mm)									
		20/21					25				
		5N					6N				
		ℓ (mm)	ap (mm)	ae (mm)	n (min ⁻¹)	Vf (mm/min)	ℓ (mm)	ap (mm)	ae (mm)	n (min ⁻¹)	Vf (mm/min)
Carbon steel (S50C, S55C) below 250HB	JC7560	70	0.4	~14	1,910	8,600	90	0.4	~18	1,530	8,260
	(JC8050)	120	0.3	~14	1,720	6,970	140	0.3	~18	1,380	6,710
	(JC8118)	190	0.25	~14	1,530	5,510	210	0.25	~18	1,220	5,270
Tool & die steel (SKD61, SKD11) below 255HB	JC7560	70	0.4	~14	1,750	7,880	90	0.4	~18	1,400	7,560
	(JC8050)	120	0.3	~14	1,580	6,400	140	0.3	~18	1,260	6,120
	(JC8118)	190	0.25	~14	1,400	5,040	210	0.25	~18	1,120	4,840
Mold steel (HPM7, PX5, P20) 30-36 HRC	JC8118	70	0.4	~14	1,750	7,880	90	0.4	~18	1,400	7,560
	(JC7560)	120	0.3	~14	1,580	6,400	140	0.3	~18	1,260	6,120
	(JC8050)	190	0.25	~14	1,400	5,040	210	0.25	~18	1,120	4,840
Mold steel (NAK80, HPM1, P21) 38-43HRC	JC8118	70	0.3	~14	1,430	5,000	90	0.3	~18	1,150	4,830
	(JC8050)	120	0.25	~14	1,290	4,060	140	0.25	~18	1,040	3,930
		190	0.2	~14	1,140	3,190	210	0.2	~18	920	3,090
Hardened die steel (SKD61, DAC, DHA) 42-52HRC	JC8118	70	0.3	~14	1,110	3,330	90	0.3	~18	890	3,200
	(JC8050)	120	0.2	~14	1,000	2,700	140	0.2	~18	800	2,590
		190	-	-	-	-	210	-	-	-	-
Hardened die steel (SKD11, SLD, DC11) 55-62HRC	JC8118	70	0.15	~14	480	600	90	0.15	~18	380	570
	EOMW	120	0.1	~14	430	480	140	0.1	~18	340	460
	Type	190	-	-	-	-	210	-	-	-	-
Grey & Nodular cast iron (FC, FCD) below 300HB	JC8118	70	0.4	~14	2,390	10,750	90	0.4	~18	1,910	10,310
	(JC7560)	120	0.35	~14	2,150	8,710	140	0.35	~18	1,720	8,360
		190	0.3	~14	1,910	6,880	210	0.3	~18	1,530	6,610
Stainless steel (SUS304) below 250HB	JC8050	70	0.4	~14	1,910	8,600	90	0.4	~18	1,530	8,260
	(JC7560)	120	0.3	~14	1,720	6,970	140	0.3	~18	1,380	6,710
		190	0.25	~14	1,530	5,510	210	0.25	~18	1,220	5,270
Titanium alloy (Ti-6Al-4V)	JC7560	70	0.3	~14	950	2,380	90	0.3	~18	760	2,280
	(JC8118)	120	0.25	~14	860	1,940	140	0.25	~18	680	1,840
	(DS118) (JC8050)	190	0.2	~14	760	1,520	210	0.2	~18	610	1,460
Heat resistant alloy (INCO718)	JC8118	70	0.3	~14	480	960	90	0.3	~18	380	910
	(DS118)	120	0.25	~14	430	860	140	0.25	~18	340	730
	(JC7560) (DS150) (JC8050)	190	0.2	~14	380	610	210	0.2	~18	300	580

Note

1. Please adjust cutting conditions according to machine rigidity or work rigidity.
2. In case of chatter occurring, recommended to reduce ap or rpm and keep feed per tooth.
3. ap should be reduced when using on low rigidity machine.
4. Use air blow.

QM MILL **MPM Type**

■ Recommended cutting conditions

● MPM type (EOMT/W insert)

1

Material	Grade	Tool dia.(mm)									
		30					32				
		7N					8N				
		ℓ (mm)	ap (mm)	ae (mm)	n (min ⁻¹)	Vf (mm/min)	ℓ (mm)	ap (mm)	ae (mm)	n (min ⁻¹)	Vf (mm/min)
Carbon steel (S50C, S55C) below 250HB	JC7560 (JC8050) (JC8118)	100	0.4	~22	1,270	8,000	100	0.4	~24	1,190	8,570
		150	0.3	~22	1,140	6,460	150	0.3	~24	1,070	6,930
		210	0.25	~22	1,020	5,140	210	0.25	~24	950	5,470
Tool & die steel (SKD61, SKD11) below 255HB	JC7560 (JC8050) (JC8118)	100	0.4	~22	1,170	7,370	100	0.4	~24	1,090	7,850
		150	0.3	~22	1,050	5,950	150	0.3	~24	980	6,350
		210	0.25	~22	940	5,330	210	0.25	~24	870	5,010
Mold steel (HPM7, PX5, P20) 30-36 HRC	JC8118 (JC7560) (JC8050)	100	0.4	~22	1,170	7,370	100	0.4	~24	1,090	7,850
		150	0.3	~22	1,050	5,950	150	0.3	~24	980	6,350
		210	0.25	~22	940	5,330	210	0.25	~24	870	5,010
Mold steel (NAK80, HPM1, P21) 38-43HRC	JC8118 (JC8050)	100	0.3	~22	950	4,660	100	0.3	~24	900	5,040
		150	0.25	~22	860	3,790	150	0.25	~24	810	4,080
		210	0.2	~22	760	2,980	210	0.2	~24	720	3,220
Hardened die steel (SKD61, DAC, DHA) 42-52HRC	JC8118 (JC8050)	100	0.3	~22	740	3,110	100	0.3	~24	700	3,360
		150	0.2	~22	670	2,530	150	0.2	~24	600	2,590
		210	0.15	~22	590	1,980	210	0.15	~24	500	1,920
Hardened die steel (SKD11, SLD, DC11) 55-62HRC	EOMW Type	100	0.15	~22	320	560	100	0.15	~24	300	600
		150	0.1	~22	290	460	150	0.1	~24	270	490
		210	-	-	-	-	210	-	-	-	-
Grey & Nodular cast iron (FC, FCD) below 300HB	JC8118 (JC7560)	100	0.4	~22	1,590	10,000	100	0.4	~24	1,490	10,730
		150	0.35	~22	1,430	8,110	150	0.35	~24	1,340	8,680
		210	0.3	~22	1,270	6,400	210	0.3	~24	1,190	6,850
Stainless steel (SUS304) below 250HB	JC8050 (JC7560)	100	0.4	~22	1,270	8,000	100	0.4	~24	1,190	8,570
		150	0.3	~22	1,140	6,460	150	0.3	~24	1,070	6,930
		210	0.25	~22	1,020	5,140	210	0.25	~24	950	5,470
Titanium alloy (Ti-6Al-4V)	JC7560 DS150 (JC8118) (DS118) (JC8050)	100	0.3	~22	640	2,240	100	0.3	~24	600	2,400
		150	0.25	~22	580	1,830	150	0.25	~24	540	1,940
		210	0.2	~22	510	1,430	210	0.2	~24	480	1,540
Heat resistant alloy (INCO718)	JC8118 DS118 (JC7560) (DS150) (JC8050)	100	0.3	~22	320	900	100	0.3	~24	300	960
		150	0.25	~22	290	730	150	0.25	~24	270	780
		210	0.2	~22	260	580	210	0.2	~24	240	610

Note

1. Please adjust cutting conditions according to machine rigidity or work rigidity.
2. In case of chatter occurring, recommended to reduce ap or rpm and keep feed per tooth.
3. ap should be reduced when using on low rigidity machine.
4. Use air blow.

QM MILL**MPM Type**

■ Recommended cutting conditions

● MPM type (EOMT/W insert)

②

Material	Grade	Tool dia.(mm)														
		10/11					12/13/14/15					16/17/18				
		2N					3N					4N				
		ℓ (mm)	a _p (mm)	a _e (mm)	n (min ⁻¹)	V _f (mm/min)	ℓ (mm)	a _p (mm)	a _e (mm)	n (min ⁻¹)	V _f (mm/min)	ℓ (mm)	a _p (mm)	a _e (mm)	n (min ⁻¹)	V _f (mm/min)
Hardened die steel (SKD61, DAC, DHA) 42-52HRC	JC8118	40	0.20	~6	2,860	2,860	50	0.20	~7	2,390	3,590	65	0.25	~12	1,790	4,300
		60	0.15	~6	2,570	2,060	70	0.15	~7	2,150	2,580	95	0.20	~12	1,610	3,090
		80	0.10	~6	2,290	1,370	95	0.10	~7	1,910	1,720	125	0.10	~12	1,430	2,060
Hardened die steel (SKD11, SLD, DC11) 55-62HRC	DH102	40	0.15	~6	2,550	1,530	50	0.15	~7	2,120	1,900	65	0.15	~12	1,590	1,900
		60	0.10	~6	2,300	1,240	70	0.10	~7	1,910	1,550	95	0.10	~12	1,430	1,520
		80	-	-	-	-	95	-	-	-	-	125	-	-	-	-

Note

1. Please adjust cutting conditions according to machine rigidity or work rigidity.
2. In case of chatter occurring, recommended to reduce a_p or rpm and keep feed per tooth.
3. a_p should be reduced when using on low rigidity machine.
4. Use air blow.

QM MILL**MPM Type**

■ Recommended cutting conditions

● MPM type (EOMT/W insert)

2

Material	Grade	Tool dia.(mm)									
		20/21					25				
		5N					6N				
		ℓ (mm)	a_p (mm)	a_e (mm)	n (min ⁻¹)	V_f (mm/min)	ℓ (mm)	a_p (mm)	a_e (mm)	n (min ⁻¹)	V_f (mm/min)
Hardened die steel (SKD61, DAC, DHA) 42-52HRC	JC8118	80	0.25	~14	1,430	4,290	100	0.25	~18	1,150	4,140
		120	0.2	~14	1,290	3,100	150	0.2	~18	1,040	3,000
		160	0.10	~14	1,140	2,050	200	0.10	~18	920	1,990
Hardened die steel (SKD11, SLD, DC11) 55-62HRC	DH102	80	0.15	~14	1,270	1,900	100	0.15	~18	1,020	1,840
		120	0.1	~14	1,140	1,540	150	0.1	~18	920	1,490
		160	-	-	-	-	200	-	-	-	-

Material	Grade	Tool dia.(mm)									
		30					32				
		7N					8N				
		ℓ (mm)	a_p (mm)	a_e (mm)	n (min ⁻¹)	V_f (mm/min)	ℓ (mm)	a_p (mm)	a_e (mm)	n (min ⁻¹)	V_f (mm/min)
Hardened die steel (SKD61, DAC, DHA) 42-52HRC	JC8118	120	0.25	~22	950	3,990	120	0.25	~24	900	4,320
		180	0.20	~22	860	2,890	180	0.20	~24	810	3,110
		240	0.10	~22	760	1,920	240	0.10	~24	720	2,070
Hardened die steel (SKD11, SLD, DC11) 55-62HRC	DH102	120	0.15	~22	850	1,780	120	0.15	~24	800	1,920
		180	0.10	~22	760	1,430	180	0.10	~24	720	1,560
		240	-	-	-	-	240	-	-	-	-

Note

1. Please adjust cutting conditions according to machine rigidity or work rigidity.
2. In case of chatter occurring, recommended to reduce a_p or rpm and keep feed per tooth.
3. a_p should be reduced when using on low rigidity machine.
4. Use air blow.

QM MILL**MPM Type**

■ Recommended cutting conditions

● MPM type (ZOMT insert)

3

Material	Chipbreaker	Grade	Tool dia.(mm)														
			10/11					12/13/15					16/17/18				
			2N					3N					4N				
			ℓ (mm)	a _p (mm)	a _p ×a _e (mm ²)	n (min ⁻¹)	V _f (mm/min)	ℓ (mm)	a _p (mm)	a _p ×a _e (mm ²)	n (min ⁻¹)	V _f (mm/min)	ℓ (mm)	a _p (mm)	a _p ×a _e (mm ²)	n (min ⁻¹)	V _f (mm/min)
Carbon steel (S50C, S55C) below 250HB	PL	JC8050 (JC8118)	50	~4.0	~6.0	5,090	810	60	~4.0	~8.0	4,240	1,020	70	~5.0	~10.0	3,180	1,020
			75	~1.2	~1.8	4,580	640	80	~1.7	~2.6	3,820	800	120	~2.0	~3.0	2,860	800
			100	~0.5	~0.8	4,070	490	110	~0.6	~1.2	3,400	610	160	~0.7	~1.3	2,550	610
Tool & die steel (SKD61, SKD11) below 255HB	PL	JC8050 (JC8118)	50	~4.0	~6.0	4,770	570	60	~4.0	~8.0	3,980	720	70	~5.0	~10.0	2,980	720
			75	~1.2	~1.8	4,300	430	80	~1.7	~2.6	3,580	540	120	~2.0	~3.0	2,690	540
			100	~0.5	~0.8	3,820	310	110	~0.6	~1.2	3,180	380	160	~0.7	~1.3	2,390	380
Mold steel (HPM7, PX5, P20) 30-36 HRC	PL	JC8118 (JC8050)	50	~4.0	~6.0	4,770	480	60	~4.0	~8.0	3,980	600	70	~5.0	~10.0	2,980	600
			75	~1.2	~1.8	4,300	340	80	~1.7	~2.6	3,580	430	120	~2.0	~3.0	2,690	430
			100	~0.5	~0.8	3,820	230	110	~0.6	~1.2	3,180	290	160	~0.7	~1.3	2,390	290
Mold steel (NAK80, HPM1, P21) 38-43HRC	PL	JC8118 (JC8050)	50	~3.0	~4.0	3,820	380	60	~3.0	~4.5	3,180	480	70	~4.0	~6.0	2,390	480
			75	~1.2	~1.6	3,440	280	80	~1.3	~1.8	2,860	340	120	~1.7	~2.2	2,150	340
			100	~0.5	~0.8	3,060	180	110	~0.6	~1.0	2,550	230	160	~0.6	~1.1	1,910	230
Hardened die steel (SKD61, DAC, DHA) 42-52HRC	PL	JC8118	50	~2.5	~3.0	3,180	320	60	~2.5	~3.5	2,650	400	70	~3.5	~5.5	1,990	400
			75	~1.0	~1.4	2,860	230	80	~1.0	~1.5	2,390	290	120	~1.4	~2.0	1,790	290
			100	~0.5	~0.6	2,550	150	110	~0.5	~0.8	2,120	190	160	~0.5	~1.0	1,590	190
Grey & Nodular cast iron (FC, FCD) below 300HB	PL	JC8118	50	~4.0	~6.0	4,770	760	60	~4.0	~8.0	3,980	960	70	~5.0	~10.0	2,980	950
			75	~1.2	~1.8	4,300	600	80	~1.7	~2.6	3,580	750	120	~2.0	~3.0	2,690	750
			100	~0.5	~0.8	3,820	460	110	~0.6	~1.2	3,180	570	160	~0.7	~1.3	2,390	570
Stainless steel (SUS304) below 250HB	PL	JC8050	50	~4.0	~6.0	4,770	570	60	~4.0	~8.0	3,980	720	70	~5.0	~10.0	2,980	720
			75	~1.2	~1.8	4,300	430	80	~1.7	~2.6	3,580	540	120	~2.0	~3.0	2,690	540
			100	~0.5	~0.8	3,820	310	110	~0.6	~1.2	3,180	380	160	~0.7	~1.3	2,390	380

Note

1. Please adjust cutting conditions according to machine rigidity or work rigidity.
2. In case of chatter occurring, recommended to reduce a_p or rpm and keep feed per tooth.
3. a_p should be reduced when using on low rigidity machine.
4. Use air blow.
5. Please scan QR code for cutting conditions of ZOMT insert for side finishing or bottom finishing.



QM MILL**MPM Type**

■ Recommended cutting conditions

● MPM type (ZOMT insert)

3

Material	Chipbreaker	Grade	Tool dia.(mm)									
			20/21					25				
			5N					6N				
			ℓ (mm)	ap (mm)	ap×ae (mm ²)	n (min ⁻¹)	Vf (mm/min)	ℓ (mm)	ap (mm)	ap×ae (mm ²)	n (min ⁻¹)	Vf (mm/min)
Carbon steel (S50C, S55C) below 250HB	PL	JC8050 (JC8118)	70	~5.0	~16.0	2,550	1,020	90	~5.0	~20.0	2,040	980
			120	~4.0	~8.0	2,290	800	140	~4.0	~10.0	1,830	770
			190	~3.0	~4.0	2,040	610	210	~3.0	~8.0	1,630	590
Tool & die steel (SKD61, SKD11) below 255HB	PL	JC8050 (JC8118)	70	~5.0	~16.0	2,390	720	90	~5.0	~20.0	1,910	690
			120	~4.0	~8.0	2,150	540	140	~4.0	~10.0	1,720	520
			190	~3.0	~4.0	1,910	380	210	~3.0	~8.0	1,530	370
Mold steel (HPM7, PX5, P20) 30-36 HRC	PL	JC8118 (JC8050)	70	~5.0	~16.0	2,390	600	90	~5.0	~20.0	1,910	570
			120	~4.0	~8.0	2,150	430	140	~4.0	~10.0	1,720	410
			190	~3.0	~4.0	1,910	290	210	~3.0	~8.0	1,530	280
Mold steel (NAK80, HPM1, P21) 38-43HRC	PL	JC8118 (JC8050)	70	~4.0	~16.0	1,910	480	90	~4.0	~20.0	1,530	460
			120	~3.0	~8.0	1,720	340	140	~3.0	~10.0	1,380	330
			190	~2.0	~4.0	1,530	230	210	~2.0	~8.0	1,220	220
Hardened die steel (SKD61, DAC, DHA) 42-52HRC	PL	JC8118	70	~3.5	~10.0	1,590	400	90	~3.5	~12.5	1,270	380
			120	~2.5	~5.0	1,430	290	140	~2.5	~6.2	1,150	280
			190	~1.2	~2.5	1,270	190	210	~1.2	~3.2	1,020	180
Grey & Nodular Cast iron (FC, FCD) below 300HB	PL	JC8118	70	~5.0	~18.0	2,390	960	90	~5.0	~25.0	1,910	920
			120	~4.0	~10.0	2,150	750	140	~4.0	~12.0	1,720	720
			190	~3.0	~5.0	1,910	570	210	~3.0	~9.0	1,530	550
Stainless steel (SUS304) below 250HB	PL	JC8050	70	~5.0	~16.0	2,390	720	90	~5.0	~20.0	1,910	690
			120	~4.0	~8.0	2,150	540	140	~4.0	~10.0	1,720	520
			190	~3.0	~4.0	1,910	380	210	~3.0	~8.0	1,530	370

Note

1. Please adjust cutting conditions according to machine rigidity or work rigidity.
2. In case of chatter occurring, recommended to reduce ap or rpm and keep feed per tooth.
3. ap should be reduced when using on low rigidity machine.
4. Use air blow.
5. Please scan QR code for cutting conditions of ZOMT insert for side finishing or bottom finishing.



QM MILL**MPM Type**

■ Recommended cutting conditions

● MPM type (ZOMT insert)

3

Material	Chipbreaker	Grade	Tool dia.(mm)									
			30					32				
			7N					8N				
			ℓ (mm)	a _p (mm)	a _p ×a _e (mm ²)	n (min ⁻¹)	V _f (mm/min)	ℓ (mm)	a _p (mm)	a _p ×a _e (mm ²)	n (min ⁻¹)	V _f (mm/min)
Carbon steel (S50C, S55C) below 250HB	PL	JC8050 (JC8118)	100	~5.0	~22.0	1,700	950	100	~5.0	~22.0	1,590	1,020
			150	~4.0	~15.0	1,530	750	150	~4.0	~15.0	1,430	800
			210	~3.0	~8.0	1,360	570	210	~3.0	~8.0	1,270	610
Tool & die steel (SKD61, SKD11) below 255HB	PL	JC8050 (JC8118)	100	~5.0	~22.0	1,590	670	100	~5.0	~22.0	1,490	720
			150	~4.0	~15.0	1,430	500	150	~4.0	~15.0	1,340	540
			210	~3.0	~8.0	1,270	360	210	~3.0	~8.0	1,190	380
Mold steel (HPM7, PX5, P20) 30-36 HRC	PL	JC8118 (JC8050)	100	~5.0	~22.0	1,590	560	100	~5.0	~22.0	1,490	600
			150	~4.0	~15.0	1,430	400	150	~4.0	~15.0	1,340	430
			210	~3.0	~8.0	1,270	270	210	~3.0	~8.0	1,190	290
Mold steel (NAK80, HPM1, P21) 38-43HRC	PL	JC8118 (JC8050)	100	~5.0	~22.0	1,270	440	100	~5.0	~22.0	1,190	480
			150	~4.0	~15.0	1,150	320	150	~4.0	~15.0	1,070	340
			210	~3.0	~8.0	1,020	210	210	~3.0	~8.0	950	230
Hardened die steel (SKD61, DAC, DHA) 42-52HRC	PL	JC8118	100	~4.0	~15.0	1,060	370	100	~4.0	~15.0	990	400
			150	~3.0	~7.5	950	270	150	~3.0	~7.5	900	290
			210	~2.0	~3.8	850	180	210	~2.0	~3.8	800	190
Grey & Nodular cast iron (FC, FCD) below 300HB	PL	JC8118	100	~5.0	~24.0	1,590	890	100	~5.0	~24.0	1,490	950
			150	~4.0	~16.0	1,430	700	150	~4.0	~16.0	1,340	750
			210	~3.0	~9.0	1,270	530	210	~3.0	~9.0	1,190	570
Stainless steel (SUS304) below 250HB	PL	JC8050	100	~5.0	~22.0	1,590	670	100	~5.0	~22.0	1,490	720
			150	~4.0	~15.0	1,430	500	150	~4.0	~15.0	1,340	540
			210	~3.0	~8.0	1,270	360	210	~3.0	~8.0	1,190	380

Note

1. Please adjust cutting conditions according to machine rigidity or work rigidity.
2. In case of chatter occurring, recommended to reduce a_p or rpm and keep feed per tooth.
3. a_p should be reduced when using on low rigidity machine.
4. Use air blow.
5. Please scan QR code for cutting conditions of ZOMT insert for side finishing or bottom finishing.



QM MILL**MPM Type**

- Recommended cutting conditions
- MPM type (YOHW insert) - Side finishing

4

Material	Grade	Tool dia.(mm)									
		10/11					12/13/14/15				
		2N					3N				
		l (mm)	a_p (mm)	a_e (mm)	n (min ⁻¹)	V_f (mm/min)	l (mm)	a_p (mm)	a_e (mm)	n (min ⁻¹)	V_f (mm/min)
Carbon steel (S50C, S55C) below 250HB	JC8015 (DH102)	~50	≤1.2	≤0.10	12,600	3,780	~60	≤1.2	≤0.10	10,600	4,770
		75	≤0.8	≤0.08	8,820	2,120	80	≤0.8	≤0.08	7,420	2,670
		100	≤0.6	≤0.08	8,820	1,760	110	≤0.6	≤0.08	7,420	2,230
Tool & die steel (SKD61, SKD11) below 255HB	JC8015 (DH102)	~50	≤1.0	≤0.10	11,400	3,420	~60	≤1.0	≤0.10	9,550	4,300
		75	≤0.7	≤0.08	7,980	1,920	80	≤0.7	≤0.08	6,690	2,400
		100	≤0.5	≤0.08	7,980	1,600	110	≤0.5	≤0.08	6,690	2,000
Mold steel (HPM7, PX5, P20) 30-36 HRC	JC8015 (DH102)	~50	≤1.0	≤0.10	11,400	3,420	~60	≤1.0	≤0.10	9,550	4,300
		75	≤0.7	≤0.08	7,980	1,920	80	≤0.7	≤0.08	6,690	2,400
		100	≤0.5	≤0.08	7,980	1,600	110	≤0.5	≤0.08	6,690	2,000
Mold steel (NAK80, HPM1, P21) 38-43HRC	DH102 (JC8015)	~50	≤1.0	≤0.10	8,880	2,130	~60	≤1.0	≤0.10	7,430	2,670
		75	≤0.7	≤0.08	6,180	1,240	80	≤0.7	≤0.08	5,200	1,560
		100	≤0.5	≤0.08	6,180	990	110	≤0.5	≤0.08	5,200	1,250
Hardened die steel (SKD61, DAC, DHA) 42-52HRC	DH102 (JC8015)	~50	≤0.8	≤0.10	6,360	1,270	~60	≤0.8	≤0.10	5,300	1,590
		75	≤0.5	≤0.08	4,440	710	80	≤0.5	≤0.08	3,710	890
		100	—	—	—	—	110	—	—	—	—
Hardened die steel (SKD11, SLD, DC11) 55-62HRC	DH102	~50	≤0.5	≤0.10	4,740	950	~60	≤0.5	≤0.10	3,980	1,190
		75	≤0.3	≤0.08	3,300	530	80	≤0.3	≤0.08	2,790	670
		100	—	—	—	—	110	—	—	—	—
Grey & Nodular cast iron (FC, FCD) below 300HB	JC8015 (DH102)	~50	≤1.2	≤0.12	12,600	3,780	~60	≤1.2	≤0.12	10,600	4,770
		75	≤0.8	≤0.10	8,820	2,120	80	≤0.8	≤0.10	7,420	2,670
		100	≤0.6	≤0.08	8,820	1,760	110	≤0.6	≤0.08	7,420	2,230
Stainless steel (SUS304) below 250HB	JC8015 (DH102)	~50	≤1.0	≤0.10	11,400	3,420	~60	≤1.0	≤0.10	9,550	4,300
		75	≤0.7	≤0.08	7,980	1,920	80	≤0.7	≤0.08	6,690	2,400
		100	≤0.5	≤0.08	7,980	1,600	110	≤0.5	≤0.08	6,690	2,000
Titanium alloy (Ti-6Al-4V)	JC8015 (DH102)	~50	≤1.0	≤0.10	2,520	600	~60	≤1.0	≤0.10	2,120	760
		75	≤0.7	≤0.08	1,740	350	80	≤0.7	≤0.08	1,480	450
		100	≤0.5	≤0.08	1,740	280	110	≤0.5	≤0.08	1,480	360

Note

1. Please adjust cutting conditions according to machine rigidity or work rigidity.
2. In case of chatter occurring, recommended to reduce a_p or rpm and keep feed per tooth.
3. a_p should be reduced when using on low rigidity machine.
4. Use air blow.

QM MILL**MPM Type**

■ Recommended cutting conditions

● MPM type (YOHW insert) - Side finishing

4

Material	Grade	Tool dia.(mm)									
		16/17/18					20/21				
		4N					5N				
		ℓ (mm)	ap (mm)	ae (mm)	n (min ⁻¹)	Vf (mm/min)	ℓ (mm)	ap (mm)	ae (mm)	n (min ⁻¹)	Vf (mm/min)
Carbon steel (S50C, S55C) below 250HB	JC8015 (DH102)	~80	≦1.2	≦0.10	7,960	4,770	~100	≦1.2	≦0.10	6,300	4,770
		120	≦0.8	≦0.08	5,560	2,670	150	≦0.8	≦0.08	4,410	2,670
		160	≦0.6	≦0.08	5,560	2,230	190	≦0.6	≦0.08	4,410	2,230
Tool & die steel (SKD61, SKD11) below 255HB	JC8015 (DH102)	~80	≦1.0	≦0.10	7,160	4,300	~100	≦1.0	≦0.10	5,700	4,300
		120	≦0.7	≦0.08	5,000	2,400	150	≦0.7	≦0.08	3,990	2,400
		160	≦0.5	≦0.08	5,000	2,000	190	≦0.5	≦0.08	3,990	2,000
Mold steel (HPM7, PX5, P20) 30-36 HRC	JC8015 (DH102)	~80	≦1.0	≦0.10	7,160	4,300	~100	≦1.0	≦0.10	5,700	4,300
		120	≦0.7	≦0.08	5,000	2,400	150	≦0.7	≦0.08	3,990	2,400
		160	≦0.5	≦0.08	5,000	2,000	190	≦0.5	≦0.08	3,990	2,000
Mold steel (NAK80, HPM1, P21) 38-43HRC	DH102 (JC8015)	~80	≦1.0	≦0.10	5,560	2,670	~100	≦1.0	≦0.10	4,440	2,670
		120	≦0.7	≦0.08	3,900	1,560	150	≦0.7	≦0.08	3,090	1,560
		160	≦0.5	≦0.08	3,900	1,250	190	≦0.5	≦0.08	3,090	1,250
Hardened die steel (SKD61, DAC, DHA) 42-52HRC	DH102 (JC8015)	~80	≦0.8	≦0.10	3,980	1,590	~100	≦0.8	≦0.10	3,180	1,590
		120	≦0.5	≦0.08	2,780	890	150	≦0.5	≦0.08	2,220	890
		160	—	—	—	—	190	—	—	—	—
Hardened die steel (SKD11, SLD, DC11) 55-62HRC	DH102	~80	≦0.5	≦0.10	2,980	1,190	~100	≦0.5	≦0.10	2,370	1,190
		120	≦0.3	≦0.08	2,080	670	150	≦0.3	≦0.08	1,650	670
		160	—	—	—	—	190	—	—	—	—
Grey & Nodular cast iron (FC, FCD) below 300HB	JC8015 (DH102)	~80	≦1.2	≦0.12	7,960	4,770	~100	≦1.2	≦0.12	6,300	4,770
		120	≦0.8	≦0.10	5,560	2,670	150	≦0.8	≦0.10	4,410	2,670
		160	≦0.6	≦0.08	5,560	2,230	190	≦0.6	≦0.08	4,410	2,230
Stainless steel (SUS304) below 250HB	JC8015 (DH102)	~80	≦1.0	≦0.10	7,160	4,300	~100	≦1.0	≦0.10	5,700	4,300
		120	≦0.7	≦0.08	5,000	2,400	150	≦0.7	≦0.08	3,990	2,400
		160	≦0.5	≦0.08	5,000	2,000	190	≦0.5	≦0.08	3,990	2,000
Titanium alloy (Ti-6Al-4V)	JC8015 (DH102)	~80	≦1.0	≦0.10	1,600	760	~100	≦1.0	≦0.10	1,260	760
		120	≦0.7	≦0.08	1,120	450	150	≦0.7	≦0.08	870	450
		160	≦0.5	≦0.08	1,120	360	190	≦0.5	≦0.08	870	360

Note

1. Please adjust cutting conditions according to machine rigidity or work rigidity.
2. In case of chatter occurring, recommended to reduce ap or rpm and keep feed per tooth.
3. ap should be reduced when using on low rigidity machine.
4. Use air blow.

QM MILL **MPM Type**

- Recommended cutting conditions
- MPM type (YOHW insert) - Side finishing

4

Material	Grade	Tool dia.(mm)														
		25					30					32				
		6N					7N					8N				
		ℓ (mm)	ap (mm)	ae (mm)	n (min ⁻¹)	Vf (mm/min)	ℓ (mm)	ap (mm)	ae (mm)	n (min ⁻¹)	Vf (mm/min)	ℓ (mm)	ap (mm)	ae (mm)	n (min ⁻¹)	Vf (mm/min)
Carbon steel (S50C, S55C) below 250HB	JC8015 (DH102)	~120	≤1.2	≤0.10	5,090	4,580	~160	≤1.2	≤0.10	4,200	4,410	~160	≤1.2	≤0.10	3,980	4,770
		190	≤0.8	≤0.08	3,560	2,560	240	≤0.8	≤0.08	2,940	2,470	240	≤0.8	≤0.08	2,780	2,670
		235	≤0.6	≤0.08	3,560	2,140	290	≤0.6	≤0.08	2,940	2,060	290	≤0.6	≤0.08	2,780	2,230
Tool & die steel (SKD61, SKD11) below 255HB	JC8015 (DH102)	~120	≤1.0	≤0.10	4,580	4,120	~160	≤1.0	≤0.10	3,800	3,990	~160	≤1.0	≤0.10	3,580	4,300
		190	≤0.7	≤0.08	3,200	2,300	240	≤0.7	≤0.08	2,660	2,230	240	≤0.7	≤0.08	2,500	2,400
		235	≤0.5	≤0.08	3,200	1,920	290	≤0.5	≤0.08	2,660	1,860	290	≤0.5	≤0.08	2,500	2,000
Mold steel (HPM7, PX5, P20) 30-36 HRC	JC8015 (DH102)	~120	≤1.0	≤0.10	4,580	4,120	~160	≤1.0	≤0.10	3,800	3,990	~160	≤1.0	≤0.10	3,580	4,300
		190	≤0.7	≤0.08	3,200	2,300	240	≤0.7	≤0.08	2,660	2,230	240	≤0.7	≤0.08	2,500	2,400
		235	≤0.5	≤0.08	3,200	1,920	290	≤0.5	≤0.08	2,660	1,860	290	≤0.5	≤0.08	2,500	2,000
Mold steel (NAK80, HPM1, P21) 38-43HRC	DH102 (JC8015)	~120	≤1.0	≤0.10	3,560	2,560	~160	≤1.0	≤0.10	2,960	2,490	~160	≤1.0	≤0.10	2,780	2,670
		190	≤0.7	≤0.08	2,490	1,490	240	≤0.7	≤0.08	2,060	1,440	240	≤0.7	≤0.08	1,950	1,560
		235	≤0.5	≤0.08	2,490	1,200	290	≤0.5	≤0.08	2,060	1,150	290	≤0.5	≤0.08	1,950	1,250
Hardened die steel (SKD61, DAC, DHA) 42-52HRC	DH102 (JC8015)	~120	≤0.8	≤0.10	2,550	1,530	~160	≤0.8	≤0.10	2,120	1,480	~160	≤0.8	≤0.10	1,990	1,590
		190	≤0.5	≤0.08	1,780	850	240	≤0.5	≤0.08	1,480	830	240	≤0.5	≤0.08	1,390	890
		235	—	—	—	—	290	—	—	—	—	290	—	—	—	—
Hardened die steel (SKD11, SLD, DC11) 55-62HRC	DH102	~120	≤0.5	≤0.10	1,910	1,150	~160	≤0.5	≤0.10	1,580	1,110	~160	≤0.5	≤0.10	1,490	1,190
		190	≤0.3	≤0.08	1,340	640	240	≤0.3	≤0.08	1,100	620	240	≤0.3	≤0.08	1,040	670
		235	—	—	—	—	290	—	—	—	—	290	—	—	—	—
Gery & Nodular cast iron (FC, FCD) below 300HB	JC8015 (DH102)	~120	≤1.2	≤0.12	5,090	4,580	~160	≤1.2	≤0.12	4,200	4,410	~160	≤1.2	≤0.12	3,980	4,770
		190	≤0.8	≤0.10	3,560	2,560	240	≤0.8	≤0.10	2,940	2,470	240	≤0.8	≤0.10	2,780	2,670
		235	≤0.6	≤0.08	3,560	2,140	290	≤0.6	≤0.08	2,940	2,060	290	≤0.6	≤0.08	2,780	2,230
Stainless steel (SUS304) below 250HB	JC8015 (DH102)	~120	≤1.0	≤0.10	4,580	4,120	~160	≤1.0	≤0.10	3,800	3,990	~160	≤1.0	≤0.10	3,580	4,300
		190	≤0.7	≤0.08	3,200	2,300	240	≤0.7	≤0.08	2,660	2,230	240	≤0.7	≤0.08	2,500	2,400
		235	≤0.5	≤0.08	3,200	1,920	290	≤0.5	≤0.08	2,660	1,860	290	≤0.5	≤0.08	2,500	2,000
Titanium alloy (Ti-6Al-4V)	JC8015 (DH102)	~120	≤1.0	≤0.10	1,020	730	~160	≤1.0	≤0.10	840	710	~160	≤1.0	≤0.10	800	760
		190	≤0.7	≤0.08	710	430	240	≤0.7	≤0.08	580	410	240	≤0.7	≤0.08	560	450
		235	≤0.5	≤0.08	710	340	290	≤0.5	≤0.08	580	320	290	≤0.5	≤0.08	560	360

Note

1. Please adjust cutting conditions according to machine rigidity or work rigidity.
2. In case of chatter occurring, recommended to reduce ap or rpm and keep feed per tooth.
3. ap should be reduced when using on low rigidity machine.
4. Use air blow.

QM MILL**MPM Type**

■ Recommended cutting conditions

● MPM type (YOHV insert) - Bottom finishing

4

Material	Grade	Tool dia.(mm)									
		10/11					12/13/14/15				
		2N					3N				
		ℓ (mm)	a _p (mm)	a _e (mm)	n (min ⁻¹)	V _f (mm/min)	ℓ (mm)	a _p (mm)	a _e (mm)	n (min ⁻¹)	V _f (mm/min)
Carbon steel (S50C, S55C) below 250HB	JC8015 (DH102)	~50	≤0.12	5~10	7,920	3,170	~60	≤0.12	6~12	6,630	3,980
		75	≤0.10	5~10	5,940	1,900	80	≤0.10	6~12	4,970	2,380
		100	≤0.10	5~8	5,100	1,430	110	≤0.10	6~10	4,300	1,800
Tool & die steel (SKD61, SKD11) below 255HB	JC8015 (DH102)	~50	≤0.12	5~10	7,320	2,640	~60	≤0.12	6~12	6,100	3,290
		75	≤0.10	5~10	5,460	1,580	80	≤0.10	6~12	4,580	1,980
		100	≤0.10	5~8	4,740	1,190	110	≤0.10	6~10	3,960	1,500
Mold steel (HPM7, PX5, P20) 30-36 HRC	JC8015 (DH102)	~50	≤0.12	5~10	7,320	2,640	~60	≤0.12	6~12	6,100	3,290
		75	≤0.10	5~10	5,460	1,580	80	≤0.10	6~12	4,580	1,980
		100	≤0.10	5~8	4,740	1,190	110	≤0.10	6~10	3,960	1,500
Mold steel (NAK80, HPM1, P21) 38-43HRC	DH102 (JC8015)	~50	≤0.12	5~10	6,360	1,530	~60	≤0.12	6~12	5,300	1,910
		75	≤0.10	5~10	4,800	920	80	≤0.10	6~12	3,980	1,150
		100	≤0.10	5~8	4,140	700	110	≤0.10	6~10	3,450	870
Hardened die steel (SKD61, DAC, DHA) 42-52HRC	DH102 (JC8015)	~50	≤0.10	5~10	3,840	770	~60	≤0.10	6~12	3,180	960
		75	≤0.08	5~10	2,880	460	80	≤0.08	6~12	2,380	570
		100	—	—	—	—	110	—	—	—	—
Hardened die steel (SKD11, SLD, DC11) 55-62HRC	DH102	~50	≤0.10	5~10	2,220	350	~60	≤0.10	6~12	1,860	450
		75	≤0.08	5~10	1,680	210	80	≤0.08	6~12	1,400	270
		100	—	—	—	—	110	—	—	—	—
Grey & Nodular cast iron (FC, FCD) below 300HB	JC8015 (DH102)	~50	≤0.15	5~10	6,360	1,910	~60	≤0.15	6~12	5,300	2,380
		75	≤0.12	5~10	4,800	1,150	80	≤0.12	6~12	3,980	1,430
		100	≤0.10	5~8	4,140	810	110	≤0.10	6~10	3,450	1,010
Stainless steel (SUS304) below 250HB	JC8015 (DH102)	~50	≤0.12	5~10	7,320	2,640	~60	≤0.12	6~12	6,100	3,290
		75	≤0.10	5~10	5,460	1,580	80	≤0.10	6~12	4,580	1,980
		100	≤0.10	5~8	4,740	1,190	110	≤0.10	6~10	3,960	1,500
Titanium alloy (Ti-6Al-4V)	JC8015 (DH102)	~50	≤0.12	5~10	1,560	370	~60	≤0.12	6~12	1,330	480
		75	≤0.10	5~10	1,200	230	80	≤0.10	6~12	1,000	290
		100	≤0.10	5~8	1,020	170	110	≤0.10	6~10	860	220

Note

1. Please adjust cutting conditions according to machine rigidity or work rigidity.
2. In case of chatter occurring, recommended to reduce a_p or rpm and keep feed per tooth.
3. a_p should be reduced when using on low rigidity machine.
4. Use air blow.

QM MILL**MPM Type**

■ Recommended cutting conditions

● MPM type (YOHW insert) - Bottom finishing

4

Material	Grade	Tool dia.(mm)									
		16/17/18					20/21				
		4N					5N				
		ℓ (mm)	a _p (mm)	a _e (mm)	n (min ⁻¹)	V _f (mm/min)	ℓ (mm)	a _p (mm)	a _e (mm)	n (min ⁻¹)	V _f (mm/min)
Carbon steel (S50C, S55C) below 250HB	JC8015 (DH102)	~80	≤0.12	8~16	4,980	3,980	~100	≤0.12	10~20	3,960	3,980
		120	≤0.10	8~16	3,740	2,380	150	≤0.10	10~20	2,970	2,380
		160	≤0.10	8~13	3,240	1,800	190	≤0.10	10~16	2,550	1,800
Tool & die steel (SKD61, SKD11) below 255HB	JC8015 (DH102)	~80	≤0.12	8~16	4,580	3,290	~100	≤0.12	10~20	3,660	3,290
		120	≤0.10	8~16	3,440	1,980	150	≤0.10	10~20	2,730	1,980
		160	≤0.10	8~13	2,980	1,500	190	≤0.10	10~16	2,370	1,500
Mold steel (HPM7, PX5, P20) 30-36 HRC	JC8015 (DH102)	~80	≤0.12	8~16	4,580	3,290	~100	≤0.12	10~20	3,660	3,290
		120	≤0.10	8~16	3,440	1,980	150	≤0.10	10~20	2,730	1,980
		160	≤0.10	8~13	2,980	1,500	190	≤0.10	10~16	2,370	1,500
Mold steel (NAK80, HPM1, P21) 38-43HRC	DH102 (JC8015)	~80	≤0.12	8~16	3,980	1,910	~100	≤0.12	10~20	3,180	1,910
		120	≤0.10	8~16	2,980	1,150	150	≤0.10	10~20	2,400	1,150
		160	≤0.10	8~13	2,580	870	190	≤0.10	10~16	2,070	870
Hardened die steel (SKD61, DAC, DHA) 42-52HRC	DH102 (JC8015)	~80	≤0.10	8~16	2,380	960	~100	≤0.10	10~20	1,920	960
		120	≤0.08	8~16	1,780	570	150	≤0.08	10~20	1,440	570
		160	—	—	—	—	190	—	—	—	—
Hardened die steel (SKD11, SLD, DC11) 55-62HRC	DH102	~80	≤0.10	8~16	1,400	450	~100	≤0.10	10~20	1,110	450
		120	≤0.08	8~16	1,040	270	150	≤0.08	10~20	840	270
		160	—	—	—	—	190	—	—	—	—
Grey & Nodular cast iron (FC, FCD) below 300HB	JC8015 (DH102)	~80	≤0.15	8~16	3,980	2,380	~100	≤0.15	10~20	3,180	2,380
		120	≤0.12	8~16	2,980	1,430	150	≤0.12	10~20	2,400	1,430
		160	≤0.10	8~13	2,580	1,010	190	≤0.10	10~16	2,070	1,010
Stainless steel (SUS304) below 250HB	JC8015 (DH102)	~80	≤0.12	8~16	4,580	3,290	~100	≤0.12	10~20	3,660	3,290
		120	≤0.10	8~16	3,440	1,980	150	≤0.10	10~20	2,730	1,980
		160	≤0.10	8~13	2,980	1,500	190	≤0.10	10~16	2,370	1,500
Titanium alloy (Ti-6Al-4V)	JC8015 (DH102)	~80	≤0.12	8~16	1,000	480	~100	≤0.12	10~20	780	480
		120	≤0.10	8~16	740	290	150	≤0.10	10~20	600	290
		160	≤0.10	8~13	640	220	190	≤0.10	10~16	510	220

Note

1. Please adjust cutting conditions according to machine rigidity or work rigidity.
2. In case of chatter occurring, recommended to reduce a_p or rpm and keep feed per tooth.
3. a_p should be reduced when using on low rigidity machine.
4. Use air blow.

QM MILL**MPM Type**

- Recommended cutting conditions
- MPM type (YOHW insert) - Bottom finishing

4

Material	Grade	Tool dia.(mm)														
		25					30					32				
		6N					7N					8N				
		ℓ (mm)	ap (mm)	ae (mm)	n (min ⁻¹)	Vf (mm/min)	ℓ (mm)	ap (mm)	ae (mm)	n (min ⁻¹)	Vf (mm/min)	ℓ (mm)	ap (mm)	ae (mm)	n (min ⁻¹)	Vf (mm/min)
Carbon steel (S50C, S55C) below 250HB	JC8015 (DH102)	~120	≤0.12	12~25	3,180	3,820	~160	≤0.12	15~30	2,640	3,700	~160	≤0.12	16~32	2,490	3,980
		190	≤0.10	12~25	2,380	2,280	240	≤0.10	15~30	1,980	2,220	240	≤0.10	16~32	1,870	2,380
		235	≤0.06	12~20	2,070	1,740	290	≤0.06	15~24	1,700	1,670	290	≤0.06	16~26	1,620	1,800
Tool & die steel (SKD61, SKD11) below 255HB	JC8015 (DH102)	~120	≤0.12	12~25	2,930	3,160	~160	≤0.12	15~30	2,440	3,070	~160	≤0.12	16~32	2,290	3,290
		190	≤0.10	12~25	2,200	1,900	240	≤0.10	15~30	1,820	1,830	240	≤0.10	16~32	1,720	1,980
		235	≤0.06	12~20	1,900	1,440	290	≤0.06	15~24	1,580	1,390	290	≤0.06	16~26	1,490	1,500
Mold steel (HPM7, PX5, P20) 30-36 HRC	JC8015 (DH102)	~120	≤0.12	12~25	2,930	3,160	~160	≤0.12	15~30	2,440	3,070	~160	≤0.12	16~32	2,290	3,290
		190	≤0.10	12~25	2,200	1,900	240	≤0.10	15~30	1,820	1,830	240	≤0.10	16~32	1,720	1,980
		235	≤0.06	12~20	1,900	1,440	290	≤0.06	15~24	1,590	1,390	290	≤0.06	16~26	1,490	1,500
Mold steel (NAK80, HPM1, P21) 38-43HRC	DH102 (JC8015)	~120	≤0.12	12~25	2,550	1,840	~160	≤0.12	15~30	2,120	1,780	~160	≤0.12	16~32	1,990	1,910
		190	≤0.10	12~25	1,910	1,100	240	≤0.10	15~30	1,600	1,080	240	≤0.10	16~32	1,490	1,150
		235	≤0.06	12~20	1,660	840	290	≤0.06	15~24	1,380	810	290	≤0.06	16~26	1,290	870
Hardened die steel (SKD61, DAC, DHA) 42-52HRC	DH102 (JC8015)	~120	≤0.10	12~25	1,530	920	~160	≤0.10	15~30	1,280	900	~160	≤0.10	16~32	1,190	960
		190	≤0.08	12~25	1,150	550	240	≤0.08	15~30	960	540	240	≤0.08	16~32	890	570
		235	—	—	—	—	290	—	—	—	—	290	—	—	—	—
Hardened die steel (SKD11, SLD, DC11) 55-62HRC	DH102	~120	≤0.10	12~25	890	430	~160	≤0.10	15~30	740	410	~160	≤0.10	16~32	700	450
		190	≤0.08	12~25	670	260	240	≤0.08	15~30	560	250	240	≤0.08	16~32	520	270
		235	—	—	—	—	290	—	—	—	—	290	—	—	—	—
Grey & Nodular cast iron (FC, FCD) below 300HB	JC8015 (DH102)	~120	≤0.15	12~25	2,550	2,300	~160	≤0.15	15~30	2,120	2,230	~160	≤0.15	16~32	1,990	2,380
		190	≤0.12	12~25	1,910	1,380	240	≤0.12	15~30	1,600	1,340	240	≤0.12	16~32	1,490	1,430
		235	≤0.10	12~20	1,660	970	290	≤0.10	15~24	1,380	940	290	≤0.10	16~26	1,290	1,010
Stainless steel (SUS304) below 250HB	JC8015 (DH102)	~120	≤0.12	12~25	2,930	3,160	~160	≤0.12	15~30	2,440	3,070	~160	≤0.12	16~32	2,290	3,290
		190	≤0.12	12~25	2,200	1,900	240	≤0.12	15~30	1,820	1,830	240	≤0.12	16~32	1,720	1,980
		235	≤0.10	12~20	1,900	1,440	290	≤0.10	15~24	1,590	1,390	290	≤0.10	16~26	1,490	1,500
Titanium alloy (Ti-6Al-4V)	JC8015 (DH102)	~120	≤0.12	12~25	640	460	~160	≤0.12	15~30	520	440	~160	≤0.12	16~32	500	480
		190	≤0.10	12~25	480	280	240	≤0.10	15~30	400	270	240	≤0.10	16~32	370	290
		235	≤0.06	12~20	420	210	290	≤0.06	15~24	340	200	290	≤0.06	16~26	320	220

Note

1. Please adjust cutting conditions according to machine rigidity or work rigidity.
2. In case of chatter occurring, recommended to reduce ap or rpm and keep feed per tooth.
3. ap should be reduced when using on low rigidity machine.
4. Use air blow.

EXTREME SAP

EXSAP/MSX Type

EXTREME SAP

EXSAP/MSX TYPE

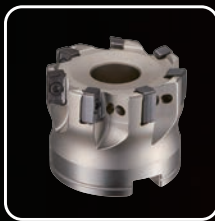

Facemill type



Modular head type



Endmill type

Various line up

Capable of a variety of applications such as facemilling , slotting and plunging

Arc-shaped cutting edge trajectory

Due to the arc-geometry on peripheral cutting edge, cusp height can be smaller even in case of large ap.

Achieves high efficient & high precision machining for side walls.

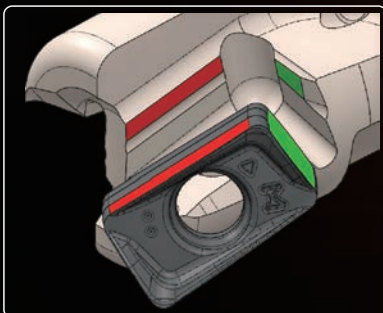

Strong clamping system

Due to unique clamping system that holds insert in place, it is possible to achieve high efficient machining in roughing application.

High precision G class periphery ground

capable of semi-finishing

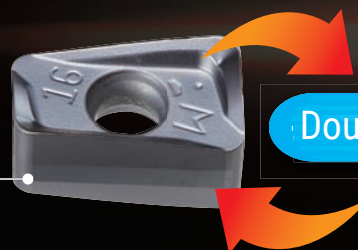

Double sided 4 cutting edge insert

EXTREME SAP **EXSAP/MSX Type**

■ **EXSAP-11 type**

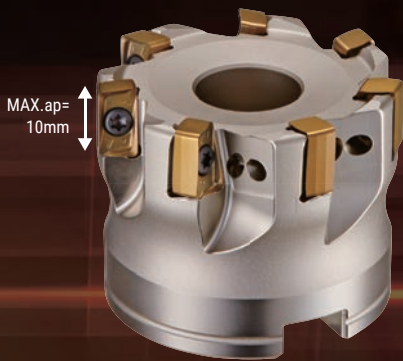

High speed machining
with multi flutes & small insert

Accuracy of tool diameter : 0-0.1mm
Achieves higher precision on semi-finishing process

Grade: **JC8050**
JC8118

PM breaker for general steel (up to 50HRC)

Grade: **JC7550**
JC7518
DS118
DS150

SL breaker for hard to cut material
such as Titanium alloy, Heat resistant alloy

■ **EXSAP-17 type**



Max.depth of cut (ap)=15mm
From roughing to semi-finishing

High rigidity insert
Achieves high precision machining even when using large ap

Grade: **JC8050**
JC8118

PM breaker for general steel (up to 50HRC)

■ **Insert grades**

ISO	P					M					K				S					
	P01	P10	P20	P30	P40	M01	M10	M20	M30	M40	K01	K10	K20	K30	S01	S10	S20	S30		
Range																				
				JC8118														DS118		
					JC8050														DS150	
				JC7518																JC7518
					JC7550															JC7550

EXTREME SAP **EXSAP/MSX Type**

- EXSAP-11 Type
- Facemill Type

Through coolant hole

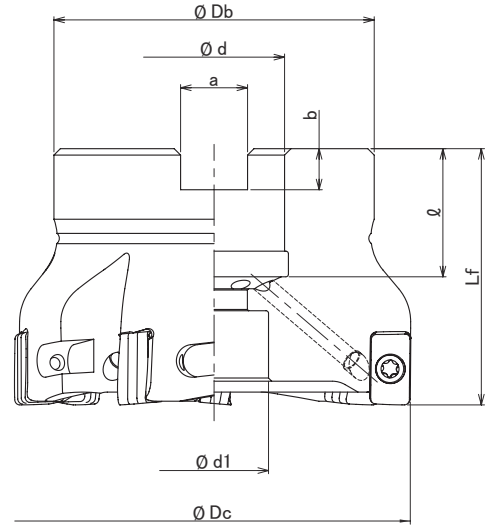

Cat.No.	Stock	No. of inserts	Dimensions (mm)								Arbor set bolt	Weight (kg)	Inserts
			φDc	Lf	φDb	φd	φd1	a	b	ℓ			
EXSAP-6040R-11-16	●	6	40	40	35	16	14	8.4	5.6	18	M8	0.22	ZNGU1105**ZER-**
EXSAP-7050R-11-22	●	7	50		47	22	16.5	10.4	6.3	20	M10	0.38	
EXSAP-7052R-11-22	●		52		50	22	17	10.4	6.3	20	M10	0.39	
EXSAP-7063R-11-22	●		63	M10							0.53		
EXSAP-7063R-11-27	●		8	80	50	27	20	12.4	7	22	M12X1.75X30*	0.62	
EXSAP-8080R-11-27	●	56			M12X1.75X30*						0.99		

Screw	Torque(N.m)	Wrench
TSW-307H	2.1	A-10

EXTREME SAP **EXSAP/MSX Type**

- EXSAP-11 Type
- Endmill Shank Type

Through coolant hole



Fig.1

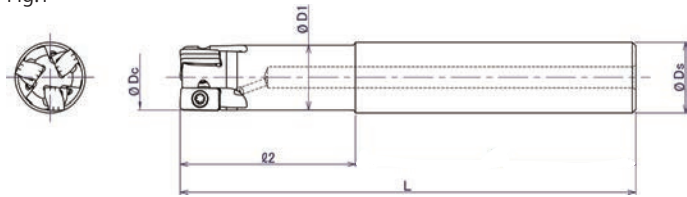

Cat.No.	Stock	No. of inserts	Dimensions (mm)					Inserts	Fig.
			φDc	ℓ2	L	φD1	φDs		
EXSAP-2016-11-50-S16+A	●	2	16	50	110	14.6	16	ZNGU1105**ZER-**	1
EXSAP-3020-11-50-S20+A	●	3	20	50	130	18.3	20		
EXSAP-3025-11-50-S25+A	●	2	25	50	130	23.4	25		
EXSAP-4030-11-50-S32+A	●	4	32	50	130	29	32		

Screw	Torque(N.m)	Wrench
TSW-307H	2.1	A-10

EXTREME SAP **EXSAP/MSX Type**

- EXSAP-11 Type
- Modular Head Type

Through coolant hole

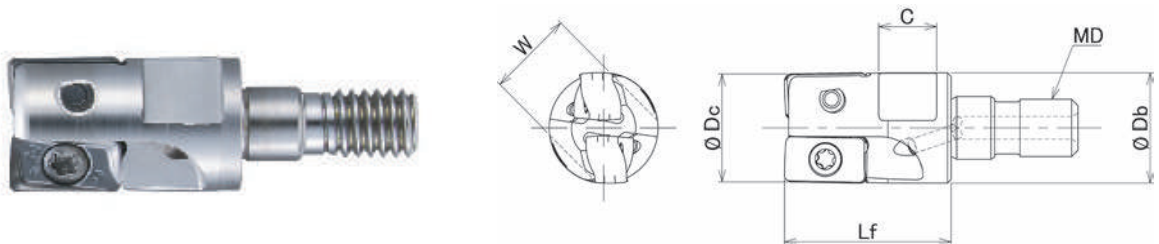

Cat.No.	Stock	No. of inserts	Dimensions (mm)						Inserts
			φDc	Lf	φDb	MD	C	W	
MSX-2016-11-M8	●	2	16	23	15	M8	8	12	ZNGU1105**ZER**
MSX-2017-11-M8	○		17						
MSX-2018-11-M8	○		18						
MSX-3020-11-M10	●	3	20	30	18	M10	9	14	
MSX-3021-11-M10	○		21						
MSX-3025-11-M12	●		25						
MSX-3026-11-M12	○	4	26	35	22	M12	11	19	
MSX-3028-11-M12	○		28						
MSX-4030-11-M16	○		30						
MSX-4032-11-M16	●	4	32	43	29	M16	12	22	
MSX-4033-11-M16	○		33						
MSX-4035-11-M16	○		35						
MSX-5040-11-M16	●	5	40						

Screw	Torque(N.m)	Wrench
TSW-307H	2.1	A-10

EXTREME SAP **EXSAP/MSX Type**

■ **Insert**

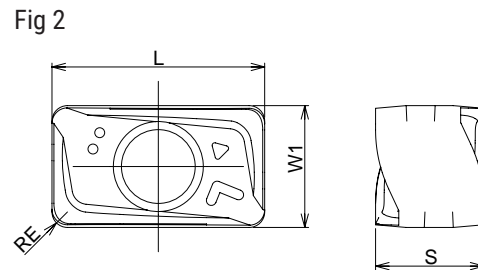
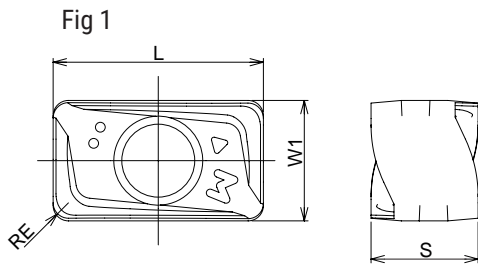

Cat.No	Tolerance	PVD Coating						Dimensions (mm)				Fig.
		DS118	DS150	JC7518	JC7550	JC8050	JC8118	RE	L	W1	S	
ZNGU110504ZER-PM	G					●	●	0.4	11	6.3	5.6	1
ZNGU110508ZER-PM						●	●	0.8				
ZNGU110516ZER-PM						●	●	1.6				
ZNGU110504ZER-SL		●	●	●	●			0.4				2
ZNGU110508ZER-SL		●	●	●	●			0.8				
ZNGU110516ZER-SL		●	●	●	●			1.6				

● **Grade markings**

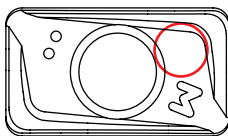

JC8118

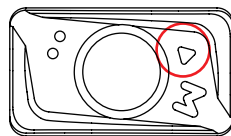

JC8050

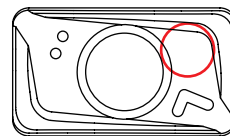

JC7518 / DS118

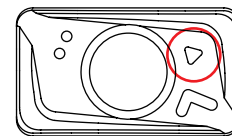

JC7550 / DS150

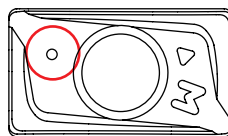

ZNGU110504ZER

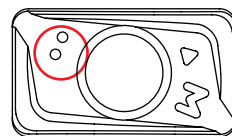

ZNGU110508ZER

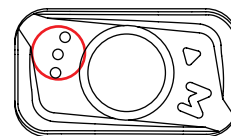

ZNGU110516ZER

EXTREME SAP

EXSAP/MSX Type

- EXSAP-17 Type
- Facemill Type



Through coolant hole

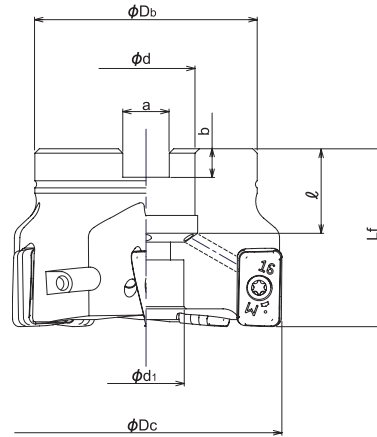

Cat.No.	Stock	No. of inserts	Dimensions (mm)								Arbor set bolt	Weight (kg)	Inserts
			φDc	Lf	φDb	φd	φd1	a	b	ℓ			
EXSAP-4050R-22	●	4	50	40	47	22	17	10.4	6.3	20	M10	0.38	ZNGU1709**ZER-PM
EXSAP-5050R-22	●	5	52									50	
EXSAP-5052R-22	●		63	0.41									
EXSAP-5063R-22	●		80	50	0.58								
EXSAP-7080R-27	●	7	100	56	27	20	12.4	7	22	M16X2X25*	1.09		
EXSAP-7100R-32	●	8	63	85	32	26	14.4	8	25	M20X2.5X40*	1.93		
EXSAP-8125R-40	●		125	100	40	32	16.4	9	32	M20X2.5X40*	3.66		

Screw	Torque(N.m)	Wrench
TSW-410H	3.5	A-15T

EXTREME SAP **EXSAP/MSX Type**

- EXSAP-17 Type
- Endmill Shank Type

Through coolant hole

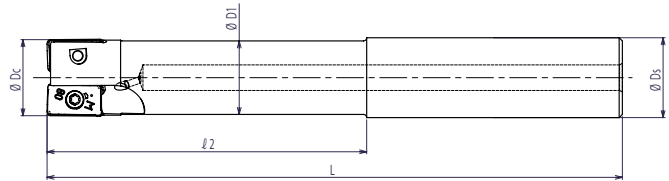

Cat.No.	Stock	No. of inserts	Dimensions (mm)					Inserts
			φDc	ℓ2	L	φD1	φDs	
EXSAP-2025-60-S25	○	2	25	60	140	23	25	ZNGU1709**ZER-PM
EXSAP-2025-100-S25	○			100	180			
EXSAP-2032-70-S32	○		32	70	150	29	32	
EXSAP-2032-120-S32	○	120		200				
EXSAP-3032-70-S32	○	70		150				
EXSAP-3032-120-S32	○	120		200				

Screw	Torque(N.m)	Wrench
TSW-410H	3.5	A-15

EXTREME SAP **EXSAP/MSX Type**

- EXSAP-17 Type
- Modular Head Type



Through coolant hole

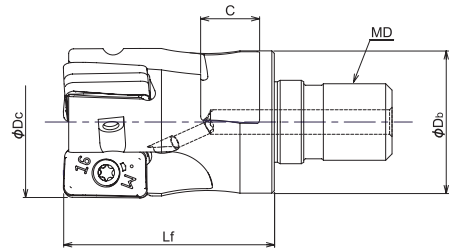
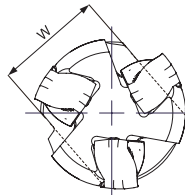
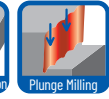

Cat.No.	Stock	No. of inserts	Dimensions (mm)						Inserts
			φDc	Lf	φDb	MD	C	W	
MSX-2025-M12	●	2	25	35	22	M12	11	19	ZNGU1709**ZER-PM
MSX-2026-M12	○		26						
MSX-2028-M12	○		28						
MSX-2030-M16	○		30						
MSX-2032-M16	●	3	32	43	29	M16	12	22	
MSX-3032-M16	●		33						
MSX-3033-M16	○		35						
MSX-3035-M16	○		40						
MSX-4040-M16	●	4	40						

Screw	Torque(N.m)	Wrench
TSW-410H	3.5	A-15

EXTREME SAP **EXSAP/MSX Type**

■ **Insert**

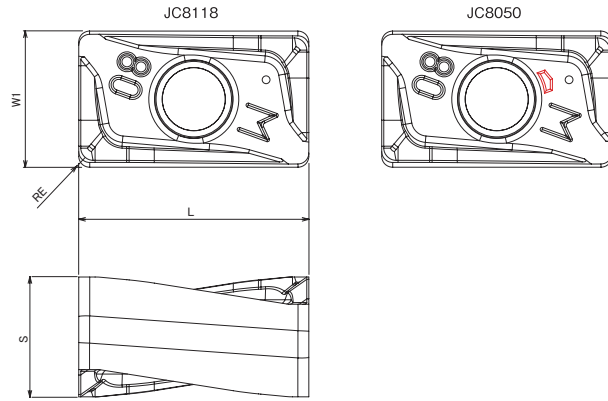

Cat.No.	Tolerance	PVD Coating		Dimensions (mm)			
		JC8050	JC8118	RE	L	W1	S
ZNGU170904ZER-PM	G	●	●	0.4	16.9	10	8.8
ZNGU170908ZER-PM		●	●	0.8			
ZNGU170916ZER-PM		●	●	1.6			
ZNGU170920ZER-PM		●	●	2			
ZNGU170930ZER-PM		●	●	3			8.6

Cat.No.	Tolerance	PVD Coating	Dimensions (mm)			
		JC7550	RE	L	W1	S
ZNGU170908ZER-SM	G	●	0.8	16.9	10	8.8

EXTREME SAP

EXSAP/MSX Type

Recommended Data for Profile Milling

EXSAP-11 Type

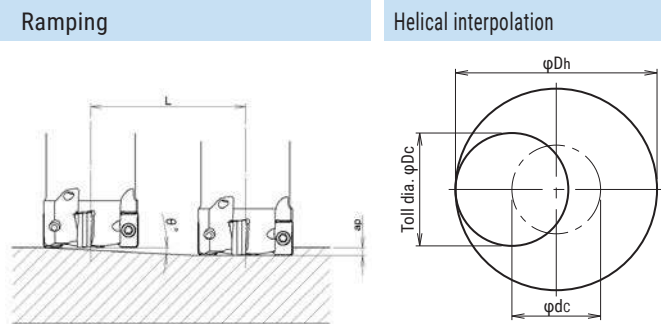

EXSAP-17 Type

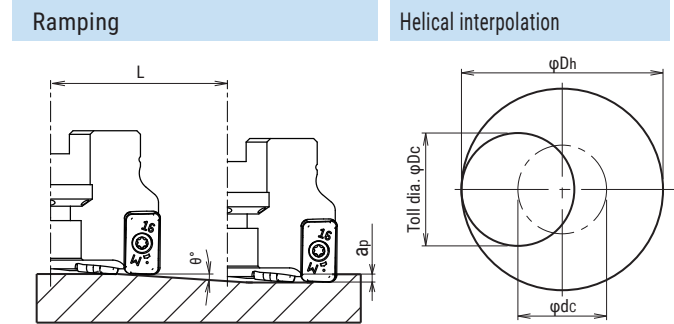

Cat. No.	Tool dia.	Effective Cutting dia.	Max. depth of cut : ap	Ramping		Helical interpolation	
				Max. ramping angle θ	Max. depth of cut : ap Total cutting length L(mm)	Min. Bore dia.	Max. Bore dia.
MSX-2016-11-M8	16	14.1	1.5	1.0°	86	18	29.6
MSX-3020-11-M10	20	18.1	1.5	0.7°	123	26	37.6
MSX-3025-11-M12	25	23.1	1.5	0.4°	215	36	47.6
MSX-4030-11-M16	30	28.1	1.5	0.3°	286	46	57.6
MSX-4032-11-M16	32	30.1	1.5	0.3°	286	50	61.6
MSX-5040-11-M16	40	38.1	1.5	0.2°	430	66	77.6
EXSAP-2016-11-**-S16	16	14.1	1.5	1.0°	86	18	29.6
EXSAP-3020-11-**-S20	20	18.1	1.5	0.7°	123	26	37.6
EXSAP-3025-11-**-S25	25	23.1	1.5	0.4°	215	36	47.6
EXSAP-4030-11-**-S32	30	28.1	1.5	0.3°	286	46	57.6
EXSAP-4032-11-**-S32	32	30.1	1.5	0.3°	286	50	61.6
EXSAP-5040-11-**-S32	40	38.1	1.5	0.2°	430	66	77.6
EXSAP-6040R-11-16	40	38.1	1.5	0.2°	430	66	77.6
EXSAP-7050R-11-22	50	48.1	1.5	0.15°	573	86	97.6
EXSAP-7052R-11-22	52	50.1	1.5	0.15°	573	90	101.6
EXSAP-7063R-11-22	63	61.1	1.5	Not recommended			
EXSAP-7063R-11-27	63	61.1	1.5	Not recommended			
EXSAP-8080R-11-27	80	78.1	1.5	Not recommended			

Cat. No.	Tool dia.	Effective Cutting dia.	Max. depth of cut : ap	Ramping		Helical interpolation	
				Max. ramping angle θ	Max. depth of cut : ap Total cutting length L(mm)	Min. Bore dia.	Max. Bore dia.
EXSAP/MSX-2025	25	21.5	1.5	0.7°	123	34	46
MSX-2026-M12	26	22.5	1.5	0.7°	123	36	48
MSX-2028-M12	28	25.5	1.5	0.6°	143	40	52
MSX-2030-M16	30	26.5	1.5	0.6°	143	44	56
EXSAP/MSX-*032	32	28.5	1.5	0.5°	172	48	60
MSX-3033-M16	33	29.5	1.5	0.5°	172	50	62
MSX-3035-M16	35	31.5	1.5	0.4°	215	54	66
MSX-4040-M16	40	36.5	1.5	0.4°	215	64	76
EXSAP-*050R-22	50	46.5	1.5	0.3°	286	84	96
EXSAP-5052R-22	52	48.5	1.5	0.3°	286	88	100
EXSAP-5063R-22	63	59.5	1.5	0.2°	430	110	122
EXSAP-7080R-27	80	76.5	1.5	0.15°	573	144	156
EXSAP-7100R-32	100	96.5	Not recommended				
EXSAP-8125R-40	125	121.5	Not recommended				

- In case of ramping and helical interpolation, apply 80% or less feed (Vf) from standard cutting condition table
- In case of helical interpolation, recommend wet cutting by coolant through the tool

- Calculation of tool pass dia.

$$\varphi_{Dc} = \varphi_{Dh} - \varphi_{Dc}$$

Tool pass dia. Bore dia. Tool Dia.

- Depth of cut per one circuit should not exceed max. depth of cut Ap

- Down cutting is recommended, tool pass rotation should be counterclockwise

EXTREME SAP**EXSAP/MSX Type**

■ Recommended cutting conditions

■ **EXSAP-11 Type**

■ Facemill type / Side milling

Material	Grade	Tool dia.(mm)									
		40					50/52				
		6N					7N				
		ℓ (mm)	a_p (mm)	$a_p \times a_e$ (mm ²)	n (min ⁻¹)	V_f (mm/min)	ℓ (mm)	a_p (mm)	$a_p \times a_e$ (mm ²)	n (min ⁻¹)	V_f (mm/min)
Carbon steel (S50C, S55C) below 250HB	JC8050 (JC8118)	~150	~8	~20	1,430	1,540	~200	~8	~24	1,150	1,610
		200	~6	~6	1,270	1,220	250	~6	~7.3	1,020	1,290
		250	~4	~2	1,110	930	300	~5	~2.4	890	1,000
Cast steel (GM190, ICD5) below 285HB	JC8050 (JC8118)	~150	~8	~20	1,430	1,540	~200	~8	~24	1,150	1,610
		200	~6	~6	1,270	1,220	250	~6	~7.3	1,020	1,290
		250	~4	~2	1,110	930	300	~5	~2.4	890	1,000
Tool & die steel (SKD61, SKD11) below 255HB	JC8050 (JC8118)	~150	~8	~20	1,430	1,540	~200	~8	~24	1,150	1,610
		200	~6	~6	1,270	1,220	250	~6	~7.3	1,020	1,290
		250	~4	~2	1,110	930	300	~5	~2.4	890	1,000
Mold steel (HPM7, PX5, P20) 30-36 HRC	JC8118 (JC8050)	~150	~8	~20	1,030	870	~200	~8	~24	830	1,050
		200	~6	~6	950	680	250	~6	~7.3	760	850
		250	~4	~2	880	530	300	~5	~2.4	700	690
Mold steel (NAK80, HPM1, P21) 38-43HRC	JC8118 (JC8050)	~150	~8	~16	950	800	~200	~8	~20	760	960
		200	~6	~4.8	840	600	250	~6	~6	670	750
		250	~4	~1.6	720	430	300	~5	~2	570	560
Hardened die steel (SKD61, DAC, DHA) 42-52HRC	JC8118	~150	~5	~4.8	800	580	~200	~6	~8	640	540
		200	~4	~1.6	720	430	250	~5	~2.4	570	400
		250	~3	~0.5	640	310	300	~4	~0.8	510	290
Grey cast iron (FC250) 160-260HB	JC8118 (JC8050)	~150	~8	~22	1,590	1,720	~200	~8	~28	1,270	1,780
		200	~6	~6.7	1,430	1,200	250	~6	~8.5	1,150	1,450
		250	~4	~2.2	1,270	910	300	~5	~2.8	1,020	1,140
Nodular cast iron (FCD700) 170-300HB	JC8118 (JC8050)	~150	~8	~22	1,430	1,370	~200	~8	~28	1,150	1,610
		200	~6	~6.7	1,270	1,070	250	~6	~8.5	1,020	1,290
		250	~4	~2.2	1,110	800	300	~5	~2.8	890	1,000
Austenitic stainless steel (SUS304, 316, 317)17Cr	JC8050 (JC7550)	~150	~8	~20	950	800	~200	~8	~24	760	960
		200	~6	~6	880	630	250	~6	~7.3	700	780
		250	~4	~2	800	480	300	~5	~2.4	640	630
Ferritic & martensitic stainless steel (SUS403, 420J2, 430)13Cr	JC8050 (JC7550)	~150	~8	~20	1,110	930	~200	~8	~24	890	1,120
		200	~6	~6	950	680	250	~6	~7.3	760	850
		250	~4	~2	800	480	300	~5	~2.4	640	630
Titanium alloy (Ti-6Al-4V) 35-43HRC	DS150 (JC7550) (DS118)	~150	~8	~14	560	440	~200	~8	~20	450	410
		200	~6	~4.2	480	350	250	~6	~6	380	320
		250	~4	~1.4	400	260	300	~5	~2	320	250
Heat resistant alloy (INCO718) 35-43HRC	DS118 (JC7518) (DS150)	~150	~8	~14	240	140	~200	~8	~20	190	130
		200	~6	~4.2	200	110	250	~6	~6	160	100
		250	~4	~1.4	160	80	300	~5	~2	130	70

Note

1. Please adjust cutting conditions according to machine rigidity or work rigidity.
2. In case of chatter occurring, recommended to reduce a_p or rpm and keep feed per tooth.
3. a_p should be reduced when using on low rigidity machine.
4. Use air blow.

EXTREME SAP

EXSAP/MSX Type

■ Recommended cutting conditions

■ **EXSAP-11 Type**

■ Facemill type / Side milling

Material	Grade	Tool dia.(mm)									
		63					80				
		7N					8N				
		ℓ (mm)	ap (mm)	ap×ae (mm ²)	n (min ⁻¹)	Vf (mm/min)	ℓ (mm)	ap (mm)	ap×ae (mm ²)	n (min ⁻¹)	Vf (mm/min)
Carbon steel (S50C, S55C) below 250HB	JC8050 (JC8118)	~250	~9	~30	910	1,270	~300	~9	~36	720	1,150
		300	~7	~9	810	1,020	~350	~7	~11	640	920
		350	~5	~3	710	800	~400	~5	~3.6	560	720
Cast steel (GM190, ICD5) below 285HB	JC8050 (JC8118)	~250	~9	~30	910	1,270	~300	~9	~36	720	1,150
		300	~7	~9	810	1,020	~350	~7	~11	640	920
		350	~5	~3	710	800	~400	~5	~3.6	560	720
Tool & die steel (SKD61, SKD11) below 255HB	JC8050 (JC8118)	~250	~9	~30	910	1,270	~300	~9	~36	720	1,150
		300	~7	~9	810	1,020	~350	~7	~11	640	920
		350	~5	~3	710	800	~400	~5	~3.6	560	720
Mold steel (HPM7, PX5, P20) 30-36 HRC	JC8118 (JC8050)	~250	~9	~30	660	830	~300	~9	~36	520	750
		300	~7	~9	610	680	~350	~7	~11	480	610
		350	~5	~3	560	550	~400	~5	~3.6	440	490
Mold steel (NAK80, HPM1, P21) 38-43HRC	JC8118 (JC8050)	~250	~9	~24	610	770	~300	~9	~28	480	690
		300	~7	~7.3	530	590	~350	~7	~8.5	420	540
		350	~5	~2.4	450	440	~400	~5	~2.8	360	400
Hardened die steel (SKD61, DAC, DHA) 42-52HRC	JC8118	~250	~9	~9	510	430	~300	~9	~10	400	380
		300	~7	~2.7	450	320	~350	~7	~3	360	290
		350	~5	~0.9	400	220	~400	~5	~1	320	200
Grey cast iron (FC250) 160-260HB	JC8118 (JC8050)	~250	~9	~34	1,010	1,410	~300	~9	~40	800	1,280
		300	~7	~10	910	1,150	~350	~7	~12	720	1,040
		350	~5	~3.4	810	910	~400	~5	~4	640	820
Nodular cast iron (FCD700) 170-300HB	JC8118 (JC8050)	~250	~9	~34	910	1,270	~300	~9	~40	720	1,150
		300	~7	~10	810	1,020	~350	~7	~12	640	920
		350	~5	~3.4	710	800	~400	~5	~4	560	720
Austenitic stainless steel (SUS304, 316, 317)17Cr	JC8050 (JC7550)	~250	~9	~30	610	770	~300	~9	~36	480	690
		300	~7	~9	560	630	~350	~7	~11	440	560
		350	~5	~3	510	500	~400	~5	~3.6	400	450
Ferritic & martensitic stainless steel (SUS403, 420J2, 430)13Cr	JC8050 (JC7550)	~250	~9	~30	710	890	~300	~9	~36	560	810
		300	~7	~9	610	680	~350	~7	~11	480	610
		350	~5	~3	510	500	~400	~5	~3.6	400	450
Titanium alloy (Ti-6Al-4V) 35-43HRC	DS150 (JC7550) (DS118)	~250	~9	~26	350	320	~300	~9	~30	280	290
		300	~7	~8	300	250	~350	~7	~9	240	230
		350	~5	~2	250	190	~400	~5	~3	200	180
Heat resistant alloy (INCO718) 35-43HRC	DS118 (JC7518) (DS150)	~250	~9	~26	150	110	~300	~9	~30	120	100
		300	~7	~8	130	80	~350	~7	~9	100	70
		350	~5	~2.6	100	60	~400	~5	~3	80	50

Note

1. Please adjust cutting conditions according to machine rigidity or work rigidity.
2. In case of chatter occurring, recommended to reduce ap or rpm and keep feed per tooth.
3. ap should be reduced when using on low rigidity machine.
4. Use air blow.

EXTREME SAP**EXSAP/MSX Type**

■ Recommended cutting conditions

■ **EXSAP-11 Type**

■ Endmill type / Side milling

Material	Grade	Tool dia.(mm)														
		16					20					25				
		2N					3N					3N				
		ℓ (mm)	ap (mm)	ap×ae (mm ²)	n (min ⁻¹)	Vf (mm/min)	ℓ (mm)	ap (mm)	ap×ae (mm ²)	n (min ⁻¹)	Vf (mm/min)	ℓ (mm)	ap (mm)	ap×ae (mm ²)	n (min ⁻¹)	Vf (mm/min)
Carbon steel (S50C, S55C) below 250HB	JC8050 (JC8118)	~30	~5	~4	3,580	1,000	~50	~5	~5	2,860	1,370	~70	~6	~7.2	2,290	1,100
		70	~3	~1.2	3,180	760	~120	~3	~1.5	2,550	1,070	120	~4	~2.2	2,040	860
Cast steel (GM190, ICD5) below 285HB	JC8050 (JC8118)	~30	~5	~4	3,580	1,000	~50	~5	~5	2,860	1,370	~70	~6	~7.2	2,290	1,100
		70	~3	~1.2	3,180	760	120	~3	~1.5	2,550	1,070	120	~4	~2.2	2,040	860
Tool & die steel (SKD61, SKD11) below 255HB	JC8050 (JC8118)	~30	~5	~4	3,580	1,000	~50	~5	~5	2,860	1,370	~70	~6	~7.2	2,290	1,100
		70	~3	~1.2	3,180	760	~120	~3	~1.5	2,550	1,070	120	~4	~2.2	2,040	860
Mold steel (HPM7, PX5, P20) 30-36 HRC	JC8118 (JC8050)	~30	~5	~4	2,590	620	~50	~5	~5	2,070	870	~70	~6	~7.2	1,660	700
		70	~3	~1.2	2,390	480	120	~3	~1.5	1,910	690	120	~4	~2.2	1,530	550
Mold steel (NAK80, HPM1, P21) 38-43HRC	JC8118 (JC8050)	~30	~5	~3.4	2,390	570	~50	~5	~4	1,910	800	~70	~6	~6	1,530	640
		70	~3	~1	2,090	420	~120	~3	~1.2	1,670	600	120	~4	~1.8	1,340	480
Hardened die steel (SKD61, DAC, DHA) 42-52HRC	JC8118	~30	~3	~1.6	1,990	320	~50	~3.5	~2	1,590	480	~70	~4	~3.2	1,270	380
		70	~2	~0.6	1,790	250	120	~2.5	~0.6	1,430	390	120	~3	~1	1,150	310
Grey cast iron (FC250) 160-260HB	JC8118 (JC8050)	~30	~5	~5	3,980	1,110	~50	~5	~6	3,180	1,530	~70	~6	~9.8	2,550	1,220
		70	~3	~1.5	3,580	860	~120	~3	~1.8	2,860	1,200	120	~4	~3	2,290	960
Nodular cast iron (FCD700) 170-300HB	JC8118 (JC8050)	~30	~5	~5	3,580	1,000	~50	~5	~6	2,860	1,370	~70	~6	~9.8	2,290	1,100
		70	~3	~1.5	3,180	760	120	~3	~1.8	2,550	1,070	120	~4	~3	2,040	860
Austenitic stainless steel (SUS304, 316, 317)17Cr	JC8050 (JC7550)	~30	~5	~4	2,390	570	~50	~5	~5	1,910	800	~70	~6	~7.2	1,530	640
		70	~3	~1.2	2,190	440	~120	~3	~1.5	1,750	630	120	~4	~2.2	1,400	500
Ferritic & martensitic stainless steel (SUS403, 420J2, 430)13Cr	JC8050 (JC7550)	~30	~5	~3.2	2,790	670	~50	~5	~5	2,230	940	~70	~6	~7.2	1,780	750
		70	~3	~1	2,390	480	120	~3	~1.5	1,910	690	120	~4	~2.2	1,530	550
Titanium alloy (Ti-6Al-4V) 35-43HRC	DS150 (JC7550) (DS118)	~30	~5	~3.2	1,390	330	~50	~5	~4	1,110	430	~70	~6	~6	890	350
		70	~3	~1	1,190	260	~120	~3	~1.2	950	340	120	~4	~1.8	760	270
Heat resistant alloy (INCO718) 35-43HRC	DS118 (JC7518) (DS150)	~30	~5	~3.2	600	110	~50	~5	~4	480	140	~70	~6	~6	380	110
		70	~3	~1	500	80	120	~3	~1.2	400	110	120	~4	~1.8	320	90

Note

1. Please adjust cutting conditions according to machine rigidity or work rigidity.
2. In case of chatter occurring, recommended to reduce ap or rpm and keep feed per tooth.
3. ap should be reduced when using on low rigidity machine.
4. Use air blow.

EXTREME SAP**EXSAP/MSX Type**

■ Recommended cutting conditions

■ **EXSAP-11 Type**

■ Endmill type / Side milling

Material	Grade	Tool dia.(mm)									
		30/32					40				
		4N					5N				
		ℓ (mm)	a_p (mm)	$a_p \times a_e$ (mm ²)	n (min ⁻¹)	V_f (mm/min)	ℓ (mm)	a_p (mm)	$a_p \times a_e$ (mm ²)	n (min ⁻¹)	V_f (mm/min)
Carbon steel (S50C, S55C) below 250HB	JC8050 (JC8118)	~70	~6	~9.8	1,790	1,150	~70	~7	~14	1,430	1,290
		120	~4	~3	1,590	890	170	~5	~4.2	1,270	1,020
Cast steel (GM190, ICD5) below 285HB	JC8050 (JC8118)	~70	~6	~9.8	1,790	1,150	~70	~7	~14	1,430	1,290
		120	~4	~3	1,590	890	170	~5	~4.2	1,270	1,020
Tool & die steel (SKD61, SKD11) below 255HB	JC8050 (JC8118)	~70	~6	~9.8	1,790	1,150	~70	~7	~14	1,430	1,290
		120	~4	~3	1,590	890	170	~5	~4.2	1,270	1,020
Mold steel (HPM7, PX5, P20) 30-36 HRC	JC8118 (JC8050)	~70	~6	~9.8	1,290	720	~70	~7	~14	1,030	720
		120	~4	~3	1,190	570	170	~5	~4.2	950	570
Mold steel (NAK80, HPM1, P21) 38-43HRC	JC8118 (JC8050)	~70	~6	~8	1,190	670	~70	~7	~10	950	670
		120	~4	~2.4	1,040	500	170	~5	~3	840	500
Hardened die steel (SKD61, DAC, DHA) 42-52HRC	JC8118	~70	~4	~3.6	990	400	~70	~4.5	~4	800	480
		120	~3	~1	900	320	170	~3.5	~1.2	720	360
Grey cast iron (FC250) 160-260HB	JC8118 (JC8050)	~70	~6	~12	1,990	1,270	~70	~7	~16	1,590	1,430
		120	~4	~3.6	1,790	1,000	170	~5	~4.8	1,430	1,000
Nodular cast iron (FCD700) 170-300HB	JC8118 (JC8050)	~70	~6	~12	1,790	1,150	~70	~7	~16	1,430	1,140
		120	~4	~3.6	1,590	890	170	~5	~4.8	1,270	890
Austenitic stainless steel (SUS304, 316, 317)17Cr	JC8050 (JC7550)	~70	~6	~9.8	1,190	670	~70	~7	~14	950	670
		120	~4	~3	1,090	520	170	~5	~4.2	880	530
Ferritic & martensitic stainless steel (SUS403, 420J2, 430)13Cr	JC8050 (JC7550)	~70	~6	~9.8	1,390	780	~70	~7	~14	1,110	780
		120	~4	~3	1,190	570	170	~5	~4.2	950	570
Titanium alloy (Ti-6Al-4V) 35-43HRC	DS150 (JC7550) (DS118)	~70	~6	~8	700	360	~70	~7	~10	560	360
		120	~4	~2.4	600	290	170	~5	~3	480	290
Heat resistant alloy (INCO718) 35-43HRC	DS118 (JC7518) (DS150)	~70	~6	~8	300	120	~70	~7	~10	240	120
		120	~4	~2.4	250	90	170	~5	~3	200	90

Note

1. Please adjust cutting conditions according to machine rigidity or work rigidity.
2. In case of chatter occurring, recommended to reduce a_p or rpm and keep feed per tooth.
3. a_p should be reduced when using on low rigidity machine.
4. Use air blow.

EXTREME SAP**EXSAP/MSX Type**

■ Recommended cutting conditions

■ **EXSAP-11 Type**

■ Modular head type / Side milling

Material	Grade	Tool dia.(mm)														
		16/17/18					20/21					25/26/28				
		2N					3N					3N				
		ℓ (mm)	a _p (mm)	a _p ×a _e (mm ²)	n (min ⁻¹)	V _f (mm/min)	ℓ (mm)	a _p (mm)	a _p ×a _e (mm ²)	n (min ⁻¹)	V _f (mm/min)	ℓ (mm)	a _p (mm)	a _p ×a _e (mm ²)	n (min ⁻¹)	V _f (mm/min)
Carbon steel (S50C, S55C) below 250HB	JC8050 (JC8118)	~80	~5	~4	3,580	1,000	~100	~5	~5	2,860	1,370	~120	~6	~7.2	2,290	1,100
		120	~3	~1.2	3,180	760	150	~3	~1.5	2,550	1,070	190	~4	~2.2	2,040	860
		160	~2	~0.4	2,790	560	190	~2	~0.5	2,230	800	235	~3	~0.7	1,780	640
Cast steel (GM190, ICD5) below 285HB	JC8050 (JC8118)	~80	~5	~4	3,580	1,000	~100	~5	~5	2,860	1,370	~120	~6	~7.2	2,290	1,100
		120	~3	~1.2	3,180	760	150	~3	~1.5	2,550	1,070	190	~4	~2.2	2,040	860
		160	~2	~0.4	2,790	560	190	~2	~0.5	2,230	800	235	~3	~0.7	1,780	640
Tool & die steel (SKD61, SKD11) below 255HB	JC8050 (JC8118)	~80	~5	~4	3,580	1,000	~100	~5	~5	2,860	1,370	~120	~6	~7.2	2,290	1,100
		120	~3	~1.2	3,180	760	150	~3	~1.5	2,550	1,070	190	~4	~2.2	2,040	860
		160	~2	~0.4	2,790	560	190	~2	~0.5	2,230	800	235	~3	~0.7	1,780	640
Mold steel (HPM7, PX5, P20) 30-36 HRC	JC8118 (JC8050)	~80	~5	~4	2,590	620	~100	~5	~5	2,070	870	~120	~6	~7.2	1,660	700
		120	~3	~1.2	2,390	480	150	~3	~1.5	1,910	690	190	~4	~2.2	1,530	550
		160	~2	~0.4	2,190	350	190	~2	~0.5	1,750	530	235	~3	~0.7	1,400	420
Mold steel (NAK80, HPM1, P21) 38-43HRC	JC8118 (JC8050)	~80	~5	~3.4	2,390	570	~100	~5	~4	1,910	800	~120	~6	~6	1,530	640
		120	~3	~1	2,090	420	150	~3	~1.2	1,670	600	190	~4	~1.8	1,340	480
		160	~2	~0.3	1,790	290	190	~2	~0.4	1,430	430	235	~3	~0.6	1,150	350
Hardened die steel (SKD61, DAC, DHA) 42-52HRC	JC8118	~80	~3	~1.6	1,990	320	~100	~3.5	~2	1,590	480	~120	~4	~3.2	1,270	380
		120	~2	~0.6	1,790	250	150	~2.5	~0.6	1,430	390	190	~3	~1	1,150	310
		160	~1	~0.2	1,590	190	190	~1.5	~0.2	1,270	300	235	~2	~0.3	1,020	240
Grey cast iron (FC250) 160-260HB	JC8118 (JC8050)	~80	~5	~5	3,980	1,110	~100	~5	~6	3,180	1,530	~120	~6	~9.8	2,550	1,220
		120	~3	~1.5	3,580	860	150	~3	~1.8	2,860	1,200	190	~4	~3	2,290	960
		160	~2	~0.5	3,180	640	190	~2	~0.6	2,550	920	235	~3	~1	2,040	730
Nodular cast iron (FCD700) 170-300HB	JC8118 (JC8050)	~80	~5	~5	3,580	1,000	~100	~5	~6	2,860	1,370	~120	~6	~9.8	2,290	1,100
		120	~3	~1.5	3,180	760	150	~3	~1.8	2,550	1,070	190	~4	~3	2,040	860
		160	~2	~0.5	2,790	560	190	~2	~0.6	2,230	800	235	~3	~1	1,780	640
Austenitic stainless steel (SUS304, 316, 317)17Cr	JC8050 (JC7550)	~80	~5	~4	2,390	570	~100	~5	~5	1,910	800	~120	~6	~7.2	1,530	640
		120	~3	~1.2	2,190	440	150	~3	~1.5	1,750	630	190	~4	~2.2	1,400	500
		160	~2	~0.4	1,990	320	190	~2	~0.5	1,590	480	235	~3	~0.7	1,270	380
Ferritic & martensitic stainless steel (SUS403, 420J2, 430)13Cr	JC8050 (JC7550)	~80	~5	~3.2	2,790	670	~100	~5	~5	2,230	940	~120	~6	~7.2	1,780	750
		120	~3	~1	2,390	480	150	~3	~1.5	1,910	690	190	~4	~2.2	1,530	550
		160	~2	~0.4	1,990	320	190	~2	~0.5	1,590	480	235	~3	~0.7	1,270	380
Titanium alloy (Ti-6Al-4V) 35-43HRC	DS150 (JC7550) (DS118)	~80	~5	~3.2	1,390	330	~100	~5	~4	1,110	430	~120	~6	~6	890	350
		120	~3	~1	1,190	260	150	~3	~1.2	950	340	190	~4	~1.8	760	270
		160	~2	~0.3	990	200	190	~2	~0.4	800	260	235	~3	~0.6	640	210
Heat resistant alloy (INCO718) 35-43HRC	DS118 (JC7518) (DS150)	~80	~5	~3.2	600	110	~100	~5	~4	480	140	~120	~6	~6.0	380	110
		120	~3	~1	500	80	150	~3	~1.2	400	110	190	~4	~1.8	320	90
		160	~2	~0.3	400	60	190	~2	~0.4	320	80	235	~3	~0.6	250	60

Note

1. Please adjust cutting conditions according to machine rigidity or work rigidity.
2. In case of chatter occurring, recommended to reduce a_p or rpm and keep feed per tooth.
3. a_p should be reduced when using on low rigidity machine.
4. Use air blow.

EXTREME SAP
EXSAP/MSX Type
Recommended cutting conditions
EXSAP-11 Type
Modular head type / Side milling

Material	Grade	Tool dia.(mm)									
		30/32/33/35					40				
		4N					5N				
		ℓ (mm)	a_p (mm)	$a_p \times a_e$ (mm ²)	n (min ⁻¹)	V_f (mm/min)	ℓ (mm)	a_p (mm)	$a_p \times a_e$ (mm ²)	n (min ⁻¹)	V_f (mm/min)
Carbon steel (S50C, S55C) below 250HB	JC8050 (JC8118)	~160	~6	~9.8	1,790	1,150	~160	~7	~14	1,430	1,290
		240	~4	~3	1,590	890	240	~5	~4.2	1,270	1,020
		290	~3	~1	1,390	670	290	~3	~1.4	1,110	780
Cast steel (GM190, ICD5) below 285HB	JC8050 (JC8118)	~160	~6	~9.8	1,790	1,150	~160	~7	~14	1,430	1,290
		240	~4	~3	1,590	890	240	~5	~4.2	1,270	1,020
		290	~3	~1	1,390	670	290	~3	~1.4	1,110	780
Tool & die steel (SKD61, SKD11) below 255HB	JC8050 (JC8118)	~160	~6	~9.8	1,790	1,150	~160	~7	~14	1,430	1,290
		240	~4	~3	1,590	890	240	~5	~4.2	1,270	1,020
		290	~3	~1	1,390	670	290	~3	~1.4	1,110	780
Mold steel (HPM7, PX5, P20) 30-36 HRC	JC8118 (JC8050)	~160	~6	~9.8	1,290	720	~160	~7	~14	1,030	720
		240	~4	~3	1,190	570	240	~5	~4.2	950	570
		290	~3	~1	1,090	440	290	~3	~1.4	880	440
Mold steel (NAK80, HPM1, P21) 38-43HRC	JC8118 (JC8050)	~160	~6	~8	1,190	670	~160	~7	~10	950	670
		240	~4	~2.4	1,040	500	240	~5	~3	840	500
		290	~3	~0.8	900	360	290	~3	~1	720	360
Hardened die steel (SKD61, DAC, DHA) 42-52HRC	JC8118	~160	~4	~3.6	990	400	~160	~4.5	~4	800	480
		240	~3	~1	900	320	240	~3.5	~1.2	720	360
		290	~2	~0.4	800	260	290	~2.5	~0.4	640	260
Grey cast iron (FC250) 160-260HB	JC8118 (JC8050)	~160	~6	~12	1,990	1,270	~160	~7	~16	1,590	1,430
		240	~4	~3.6	1,790	1,000	240	~5	~4.8	1,430	1,000
		290	~3	~1.2	1,590	760	290	~3	~1.6	1,270	760
Nodular cast iron (FCD700) 170-300HB	JC8118 (JC8050)	~160	~6	~12	1,790	1,150	~160	~7	~16	1,430	1,140
		240	~4	~3.6	1,590	890	240	~5	~4.8	1,270	890
		290	~3	~1.2	1,390	670	290	~3	~1.6	1,110	670
Austenitic stainless steel (SUS304, 316, 317)17Cr	JC8050 (JC7550)	~160	~6	~9.8	1,190	670	~160	~7	~14	950	670
		240	~4	~3	1,090	520	240	~5	~4.2	880	530
		290	~3	~1	990	400	290	~3	~1.4	800	400
Ferritic & martensitic stainless steel (SUS403, 420J2, 430)13Cr	JC8050 (JC7550)	~160	~6	~9.8	1,390	780	~160	~7	~14	1,110	780
		240	~4	~3	1,190	570	240	~5	~4.2	950	570
		290	~3	~1	990	400	290	~3	~1.4	800	400
Titanium alloy (Ti-6Al-4V) 35-43HRC	DS150 (JC7550) (DS118)	~160	~6	~8	700	360	~160	~7	~10	560	360
		240	~4	~2.4	600	290	240	~5	~3	480	290
		290	~3	~0.8	500	220	290	~3	~1	400	220
Heat resistant alloy (INCO718) 35-43HRC	DS118 (JC7518) (DS150)	~160	~6	~8	300	120	~160	~7	~10	240	120
		240	~4	~2.4	250	90	240	~5	~3	200	90
		290	~3	~0.8	200	60	290	~3	~1	160	60

Note

1. Please adjust cutting conditions according to machine rigidity or work rigidity.
2. In case of chatter occurring, recommended to reduce a_p or rpm and keep feed per tooth.
3. a_p should be reduced when using on low rigidity machine.
4. Use air blow.

EXTREME SAP**EXSAP/MSX Type**

■ Recommended cutting conditions

■ **EXSAP-11 Type**

■ Facemill type / Face milling

Material	Grade	Tool dia.(mm)									
		40					50/52				
		刃数6N					刃数7N				
		ℓ (mm)	a_p (mm)	a_e (mm)	n (min^{-1})	V_f (mm/min)	ℓ (mm)	a_p (mm)	a_e (mm)	n (min^{-1})	V_f (mm/min)
Carbon steel (S50C, S55C) below 250HB	JC8050 (JC8118)	~150	~2	~24	1,430	1,720	~200	~2	~30	1,150	1,610
		200	~1.2	~24	1,270	1,300	250	~1.2	~30	1,020	1,210
		250	~0.5	~24	1,110	930	300	~0.5	~30	890	870
Cast steel (GM190, JCD5) below 285HB	JC8050 (JC8118)	~150	~2	~24	1,430	1,720	~200	~2	~30	1,150	1,610
		200	~1.2	~24	1,270	1,300	250	~1.2	~30	1,020	1,210
		250	~0.5	~24	1,110	930	300	~0.5	~30	890	870
Tool & die steel (SKD61, SKD11) below 255HB	JC8050 (JC8118)	~150	~2	~24	1,430	1,720	~200	~2	~30	1,150	1,610
		200	~1.2	~24	1,270	1,300	250	~1.2	~30	1,020	1,210
		250	~0.5	~24	1,110	930	300	~0.5	~30	890	870
Mold steel (HPM7, PX5, P20) 30-36 HRC	JC8118 (JC8050)	~150	~2	~24	1,030	1,110	~200	~2	~30	830	1,050
		200	~1.2	~24	950	860	250	~1.2	~30	760	800
		250	~0.5	~24	880	630	300	~0.5	~30	700	590
Mold steel (NAK80, HPM1, P21) 38-43HRC	JC8118 (JC8050)	~150	~1.8	~24	950	910	~200	~1.8	~30	760	850
		200	~1	~24	840	660	250	~1	~30	670	610
		250	~0.5	~24	720	430	300	~0.5	~30	570	400
Hardened die steel (SKD61, DAC, DHA) 42-52HRC	JC8118	~150	~1	~16	800	580	~200	~1	~20	640	540
		200	~0.5	~16	720	430	250	~0.5	~20	570	400
		250	~0.3	~16	640	310	300	~0.3	~20	510	290
Grey cast iron (FC250) 160-260HB	JC8118 (JC8050)	~150	~2	~24	1,590	1,910	~200	~2	~30	1,270	1,780
		200	~1.2	~24	1,430	1,460	250	~1.2	~30	1,150	1,370
		250	~0.5	~24	1,270	1,070	300	~0.5	~30	1,020	1,000
Nodular cast iron (FCD700) 170-300HB	JC8118 (JC8050)	~150	~2	~24	1,430	1,720	~200	~2	~30	1,150	1,610
		200	~1.2	~24	1,270	1,300	250	~1	~30	1,020	1,210
		250	~0.5	~24	1,110	930	300	~0.5	~30	890	870
Austenitic stainless steel (SUS304, 316, 317) 17Cr	JC8050 (JC7550)	~150	~2	~16	950	1,030	~200	~2	~20	760	960
		200	~1.2	~16	880	900	250	~1.2	~20	700	830
		250	~0.5	~16	800	670	300	~0.5	~20	640	630
Ferritic & martensitic stainless steel (SUS403, 420J2, 430) 13Cr	JC8050 (JC7550)	~150	~2	~24	1,110	1,200	~200	~2	~30	890	1,120
		200	~1.2	~24	950	970	250	~1.2	~30	760	900
		250	~0.5	~24	800	670	300	~0.5	~30	640	630
Titanium alloy (Ti-6Al-4V) 35-43HRC	DS150 (JC7550) (DS118)	~150	~1.8	~16	560	400	~200	~1.8	~20	450	380
		200	~1	~16	480	290	250	~1	~20	380	270
		250	~0.4	~16	400	190	300	~0.4	~20	320	180
Heat resistant alloy (INCO718) 35-43HRC	DS118 (JC7518) (DS150)	~150	~1.8	~16	240	160	~200	~1.8	~20	190	150
		200	~1	~16	200	110	250	~1	~20	160	100
		250	~0.4	~16	160	70	300	~0.4	~20	130	60

Note

1. Please adjust cutting conditions according to machine rigidity or work rigidity.
2. In case of chatter occurring, recommended to reduce a_p or rpm and keep feed per tooth.
3. a_p should be reduced when using on low rigidity machine.
4. Use air blow.
5. In case of slotting, apply 50% or less feed (V_f) from standard cutting condition table.

EXTREME SAP
EXSAP/MSX Type
Recommended cutting conditions
EXSAP-11 Type
Facemill type / Face milling

Material	Grade	Tool dia.(mm)									
		63					80				
		7N					8N				
		ℓ (mm)	a_p (mm)	a_e (mm)	n (mm)	V_f (mm/min)	ℓ (mm)	a_p (mm)	a_e (mm)	n (min ⁻¹)	V_f (mm/min)
Carbon steel (S50C, S55C) below 250HB	JC8050 (JC8118)	~250	~2	~38	910	1,270	~300	~2	~48	720	1,150
		300	~1.2	~38	810	960	~350	~1.2	~48	640	870
		350	~0.5	~38	710	700	~400	~0.5	~48	560	630
Cast steel (GM190, ICD5) below 285HB	JC8050 (JC8118)	~250	~2	~38	910	1,270	~300	~2	~48	720	1,150
		300	~1.2	~38	810	960	~350	~1.2	~48	640	870
		350	~0.5	~38	710	700	~400	~0.5	~48	560	630
Tool & die steel (SKD61, SKD11) below 255HB	JC8050 (JC8118)	~250	~2	~38	910	1,270	~300	~2	~48	720	1,150
		300	~1.2	~38	810	960	~350	~1.2	~48	640	870
		350	~0.5	~38	710	700	~400	~0.5	~48	560	630
Mold steel (HPM7, PX5, P20) 30-36 HRC	JC8118 (JC8050)	~250	~2	~38	660	830	~300	~2	~48	520	750
		300	~1.2	~38	610	640	~350	~1.2	~48	480	580
		350	~0.5	~38	560	470	~400	~0.5	~48	440	420
Mold steel (NAK80, HPM1, P21) 38-43HRC	JC8118 (JC8050)	~250	~1.8	~38	610	680	~300	~1.8	~48	480	610
		300	~1	~38	530	480	~350	~1	~48	420	440
		350	~0.5	~38	450	320	~400	~0.5	~48	360	290
Hardened die steel (SKD61, DAC, DHA) 42-52HRC	JC8118	~250	~1	~25	510	430	~300	~1	~32	400	380
		300	~0.5	~25	450	320	~350	~0.5	~32	360	290
		350	~0.3	~25	400	220	~400	~0.3	~32	320	200
Grey cast iron (FC250) 160-260HB	JC8118 (JC8050)	~250	~2	~38	1,010	1,410	~300	~2	~48	800	1,280
		300	~1.2	~38	910	1,080	~350	~1.2	~48	720	980
		350	~0.5	~38	810	790	~400	~0.5	~48	640	720
Nodular cast iron (FCD700) 170-300HB	JC8118 (JC8050)	~250	~2	~38	910	1,270	~300	~2	~48	720	1,150
		300	~1.2	~38	810	960	~350	~1.2	~48	640	870
		350	~0.5	~38	710	700	~400	~0.5	~48	560	630
Austenitic stainless steel (SUS304, 316, 317) 17Cr	JC8050 (JC7550)	~250	~2	~25	610	770	~300	~2	~32	480	690
		300	~1.2	~25	560	670	~350	~1.2	~32	440	600
		350	~0.5	~25	510	500	~400	~0.5	~32	400	450
Ferritic & martensitic stainless steel (SUS403, 420J2, 430) 13Cr	JC8050 (JC7550)	~250	~2	~38	710	890	~300	~2	~48	560	810
		300	~1.2	~38	610	730	~350	~1.2	~48	480	650
		350	~0.5	~38	510	500	~400	~0.5	~48	400	450
Titanium alloy (Ti-6Al-4V) 35-43HRC	DS150 (JC7550) (DS118)	~250	~1.8	~25	350	290	~300	~1.8	~32	280	270
		300	~1	~25	300	210	~350	~1	~32	240	190
		350	~0.4	~25	250	140	~400	~0.4	~32	200	130
Heat resistant alloy (INCO718) 35-43HRC	DS118 (JC7518) (DS150)	~250	~1.8	~25	150	120	~300	~1.8	~32	120	110
		300	~1	~25	130	80	~350	~1	~32	100	70
		350	~0.4	~25	100	50	~400	~0.4	~32	80	40

Note

1. Please adjust cutting conditions according to machine rigidity or work rigidity.
2. In case of chatter occurring, recommended to reduce a_p or rpm and keep feed per tooth.
3. a_p should be reduced when using on low rigidity machine.
4. Use air blow.
5. In case of slotting, apply 50% or less feed (V_f) from standard cutting condition table.

EXTREME SAP**EXSAP/MSX Type**

■ Recommended cutting conditions

■ **EXSAP-11 Type**

■ Endmill type / Face milling

Material	Grade	Tool dia.(mm)														
		16					20					25				
		2N					3N					3N				
		ℓ (mm)	a _p (mm)	a _e (mm)	n (min ⁻¹)	V _f (mm/min)	ℓ (mm)	a _p (mm)	a _e (mm)	n (min ⁻¹)	V _f (mm/min)	ℓ (mm)	a _p (mm)	a _e (mm)	n (min ⁻¹)	V _f (mm/min)
Carbon steel (S50C, S55C) below 250HB	JC8050 (JC8118)	~30	~1	~10	2,980	830	~70	~1.2	~12	2,390	1,150	~70	~1.2	~15	1,910	920
		70	~0.5	~10	2,590	570	120	~0.6	~12	2,070	810	120	~0.6	~15	1,660	650
Cast steel (GM190, ICD5) below 285HB	JC8050 (JC8118)	~30	~1	~10	2,980	830	~70	~1.2	~12	2,390	1,150	~70	~1.2	~15	1,910	920
		70	~0.5	~10	2,590	570	120	~0.6	~12	2,070	810	120	~0.6	~15	1,660	650
Tool & die steel (SKD61, SKD11) below 255HB	JC8050 (JC8118)	~30	~1	~10	2,980	830	~70	~1.2	~12	2,390	1,150	~70	~1.2	~15	1,910	920
		70	~0.5	~10	2,590	570	120	~0.6	~12	2,070	810	120	~0.6	~15	1,660	650
Mold steel (HPM7, PX5, P20) 30-36 HRC	JC8118 (JC8050)	~30	~1	~10	2,590	670	~70	~1.2	~12	2,070	930	~70	~1.2	~15	1,660	750
		70	~0.5	~10	2,390	480	120	~0.6	~12	1,910	690	120	~0.6	~15	1,530	550
Mold steel (NAK80, HPM1, P21) 38-43HRC	JC8118 (JC8050)	~30	~0.8	~10	2,190	530	~70	~1	~12	1,750	740	~70	~1	~15	1,400	590
		70	~0.4	~10	1,990	360	120	~0.5	~12	1,590	520	120	~0.5	~15	1,270	420
Hardened die steel (SKD61, DAC, DHA) 42-52HRC	JC8118	~30	~0.4	~6	1,790	360	~70	~0.5	~8	1,430	430	~70	~0.5	~10	1,150	350
		70	~0.3	~6	1,590	250	120	~0.4	~8	1,270	300	120	~0.4	~10	1,020	240
Grey cast iron (FC250) 160-260HB	JC8118 (JC8050)	~30	~1	~10	3,580	1,000	~70	~1.2	~12	2,860	1,370	~70	~1.2	~15	2,290	1,100
		70	~0.5	~10	3,180	700	120	~0.6	~12	2,550	990	120	~0.6	~15	2,040	800
Nodular cast iron (FCD700) 170-300HB	JC8118 (JC8050)	~30	~1	~10	2,790	780	~70	~1.2	~12	2,230	1,070	~70	~1.2	~15	1,780	850
		70	~0.5	~10	2,590	570	120	~0.6	~12	2,070	810	120	~0.6	~15	1,660	650
Austenitic stainless steel (SUS304, 316, 317)17Cr	JC8050 (JC7550)	~30	~1	~6	2,190	610	~70	~1.2	~8	1,750	840	~70	~1.2	~10	1,400	670
		70	~0.5	~6	1,990	440	120	~0.6	~8	1,590	620	120	~0.6	~10	1,270	500
Ferritic & martensitic stainless steel (SUS403, 420J2, 430)13Cr	JC8050 (JC7550)	~30	~1	~10	2,980	830	~70	~1.2	~12	2,390	1,150	~70	~1.2	~15	1,910	920
		70	~0.5	~10	2,590	570	120	~0.6	~12	2,070	810	120	~0.6	~15	1,660	650
Titanium alloy (Ti-6Al-4V) 35-43HRC	DS150 (JC7550) (DS118)	~30	~0.8	~6	1,190	240	~70	~1	~8	950	290	~70	~1	~10	760	230
		70	~0.4	~6	990	160	120	~0.5	~8	800	190	120	~0.5	~10	640	150
Heat resistant alloy (INCO718) 35-43HRC	DS118 (JC7518) (DS150)	~30	~0.8	~6	600	110	~70	~1	~8	480	130	~70	~1	~10	380	110
		70	~0.4	~6	500	70	120	~0.5	~8	400	80	120	~0.5	~10	320	80

Note

1. Please adjust cutting conditions according to machine rigidity or work rigidity.
2. In case of chatter occurring, recommended to reduce a_p or rpm and keep feed per tooth.
3. a_p should be reduced when using on low rigidity machine.
4. Use air blow.
5. In case of slotting, apply 50% or less feed (V_f) from standard cutting condition table.

EXTREME SAP

EXSAP/MSX Type

■ Recommended cutting conditions

■ **EXSAP-11 Type**

■ Endmill type / Face milling

Material	Grade	Tool dia.(mm)									
		30/32					40				
		4N					5N				
		ℓ (mm)	ap (mm)	ae (mm)	n (min ⁻¹)	Vf (mm/min)	ℓ (mm)	ap (mm)	ae (mm)	n (min ⁻¹)	Vf (mm/min)
Carbon steel (S50C, S55C) below 250HB	JC8050 (JC8118)	~70	~1.5	~18	1,590	1,020	~70	~1.6	~24	1,430	1,290
		120	~0.8	~18	1,380	720	170	~1	~24	1,270	950
Cast steel (GM190, ICD5) below 285HB	JC8050 (JC8118)	~70	~1.5	~18	1,590	1,020	~70	~1.6	~24	1,430	1,290
		120	~0.8	~18	1,380	720	170	~1	~24	1,270	950
Tool & die steel (SKD61, SKD11) below 255HB	JC8050 (JC8118)	~70	~1.5	~18	1,590	1,020	~70	~1.6	~24	1,430	1,290
		120	~0.8	~18	1,380	720	170	~1	~24	1,270	950
Mold steel (HPM7, PX5, P20) 30-36 HRC	JC8118 (JC8050)	~70	~1.5	~18	1,380	830	~70	~1.6	~24	1,030	820
		120	~0.8	~18	1,270	610	170	~1	~24	950	620
Mold steel (NAK80, HPM1, P21) 38-43HRC	JC8118 (JC8050)	~70	~1.2	~18	1,170	660	~70	~1.4	~24	950	710
		120	~0.6	~18	1,060	470	170	~0.8	~24	840	500
Hardened die steel (SKD61, DAC, DHA) 42-52HRC	JC8118	~70	~0.6	~12	950	380	~70	~0.8	~16	800	440
		120	~0.4	~12	850	270	170	~0.4	~16	720	320
Grey cast iron (FC250) 160-260HB	JC8118 (JC8050)	~70	~1.5	~18	1,910	1,220	~70	~1.6	~24	1,590	1,430
		120	~0.8	~18	1,700	880	170	~1	~24	1,430	1,070
Nodular cast iron (FCD700) 170-300HB	JC8118 (JC8050)	~70	~1.5	~18	1,490	950	~70	~1.6	~24	1,430	1,290
		120	~0.8	~18	1,380	720	170	~1	~24	1,270	950
Austenitic stainless steel (SUS304, 316, 317) 17Cr	JC8050 (JC7550)	~70	~1.5	~12	1,170	750	~70	~1.6	~16	950	860
		120	~0.8	~12	1,060	550	170	~1	~16	880	660
Ferritic & martensitic stainless steel (SUS403, 420J2, 430) 13Cr	JC8050 (JC7550)	~70	~1.5	~18	1,590	1,020	~70	~1.6	~24	1,110	1,000
		120	~0.8	~18	1,380	720	170	~1	~24	950	710
Titanium alloy (Ti-6Al-4V) 35-43HRC	DS150 (JC7550) (DS118)	~70	~0.8	~12	640	260	~70	~1.4	~16	560	310
		120	~0.5	~12	530	170	170	~0.8	~16	480	220
Heat resistant alloy (INCO718) 35-43HRC	DS118 (JC7518) (DS150)	~70	~0.8	~12	320	130	~70	~1.4	~16	240	120
		120	~0.5	~12	270	90	170	~0.8	~16	200	80

Note

1. Please adjust cutting conditions according to machine rigidity or work rigidity.
2. In case of chatter occurring, recommended to reduce ap or rpm and keep feed per tooth.
3. ap should be reduced when using on low rigidity machine.
4. Use air blow.
5. In case of slotting , apply 50% or less feed (Vf) from standard cutting condition table.

EXTREME SAP**EXSAP/MSX Type**

■ Recommended cutting conditions

■ **EXSAP-11 Type**

■ Modular head type / Face milling

Material	Grade	Tool dia.(mm)														
		16/17/18					20/21					25/26/28				
		2N					3N					3N				
		ℓ (mm)	a _p (mm)	a _e (mm)	n (min ⁻¹)	V _f (mm/min)	ℓ (mm)	a _p (mm)	a _e (mm)	n (min ⁻¹)	V _f (mm/min)	ℓ (mm)	a _p (mm)	a _e (mm)	n (min ⁻¹)	V _f (mm/min)
Carbon steel (S50C, S55C) below 250HB	JC8050 (JC8118)	~80	~1	~10	2,980	830	~100	~1.2	~12	2,390	1,150	~120	~1.2	~15	1,910	920
		120	~0.5	~10	2,590	570	150	~0.6	~12	2,070	810	190	~0.6	~15	1,660	650
		160	~0.2	~10	2,190	350	190	~0.3	~12	1,750	530	235	~0.3	~15	1,400	420
Cast steel (GM190, ICD5) below 285HB	JC8050 (JC8118)	~80	~1	~10	2,980	830	~100	~1.2	~12	2,390	1,150	~120	~1.2	~15	1,910	920
		120	~0.5	~10	2,590	570	150	~0.6	~12	2,070	810	190	~0.6	~15	1,660	650
		160	~0.2	~10	2,190	350	190	~0.3	~12	1,750	530	235	~0.3	~15	1,400	420
Tool & die steel (SKD61, SKD11) below 255HB	JC8050 (JC8118)	~80	~1	~10	2,980	830	~100	~1.2	~12	2,390	1,150	~120	~1.2	~15	1,910	920
		120	~0.5	~10	2,590	570	150	~0.6	~12	2,070	810	190	~0.6	~15	1,660	650
		160	~0.2	~10	2,190	350	190	~0.3	~12	1,750	530	235	~0.3	~15	1,400	420
Mold steel (HPM7, PX5, P20) 30-36 HRC	JC8118 (JC8050)	~80	~1	~10	2,590	670	~100	~1.2	~12	2,070	930	~120	~1.2	~15	1,660	750
		120	~0.5	~10	2,390	480	150	~0.6	~12	1,910	690	190	~0.6	~15	1,530	550
		160	~0.2	~10	2,190	310	190	~0.3	~12	1,750	470	235	~0.3	~15	1,400	380
Mold steel (NAK80, HPM1, P21) 38-43HRC	JC8118 (JC8050)	~80	~0.8	~10	2,190	530	~100	~1	~12	1,750	740	~120	~1	~15	1,400	590
		120	~0.4	~10	1,990	360	150	~0.5	~12	1,590	520	190	~0.5	~15	1,270	420
		160	~0.2	~10	1,790	210	190	~0.3	~12	1,430	340	235	~0.3	~15	1,150	280
Hardened die steel (SKD61, DAC, DHA) 42-52HRC	JC8118	~80	~0.4	~6	1,790	360	~100	~0.5	~8	1,430	430	~120	~0.5	~10	1,150	350
		120	~0.3	~6	1,590	250	150	~0.4	~8	1,270	300	190	~0.4	~10	1,020	240
		160	~0.2	~6	1,390	170	190	~0.2	~8	1,110	200	235	~0.2	~10	890	160
Grey cast iron (FC250) 160-260HB	JC8118 (JC8050)	~80	~1	~10	3,580	1,000	~100	~1.2	~12	2,860	1,370	~120	~1.2	~15	2,290	1,100
		120	~0.5	~10	3,180	700	150	~0.6	~12	2,550	990	190	~0.6	~15	2,040	800
		160	~0.2	~10	2,790	450	190	~0.3	~12	2,230	670	235	~0.3	~15	1,780	530
Nodular cast iron (FCD700) 170-300HB	JC8118 (JC8050)	~80	~1	~10	2,790	780	~100	~1.2	~12	2,230	1,070	~120	~1.2	~15	1,780	850
		120	~0.5	~10	2,590	570	150	~0.6	~12	2,070	810	190	~0.6	~15	1,660	650
		160	~0.2	~10	2,390	380	190	~0.3	~12	1,910	570	235	~0.3	~15	1,530	460
Austenitic stainless steel (SUS304, 316, 317) 17Cr	JC8050 (JC7550)	~80	~1	~6	2,190	610	~100	~1.2	~8	1,750	840	~120	~1.2	~10	1,400	670
		120	~0.5	~6	1,990	440	150	~0.6	~8	1,590	620	190	~0.6	~10	1,270	500
		160	~0.2	~6	1,790	290	190	~0.3	~8	1,430	430	235	~0.3	~10	1,150	350
Ferritic & martensitic stainless steel (SUS403, 420J2, 430) 13Cr	JC8050 (JC7550)	~80	~1	~10	2,980	830	~100	~1.2	~12	2,390	1,150	~120	~1.2	~15	1,910	920
		120	~0.5	~10	2,590	570	150	~0.6	~12	2,070	810	190	~0.6	~15	1,660	650
		160	~0.2	~10	2,190	350	190	~0.3	~12	1,750	530	235	~0.3	~15	1,400	420
Titanium alloy (Ti-6Al-4V) 35-43HRC	DS150 (JC7550) (DS118)	~80	~0.8	~6	1,190	240	~100	~1	~8	950	290	~120	~1	~10	760	230
		120	~0.4	~6	990	160	150	~0.5	~8	800	190	190	~0.5	~10	640	150
		160	~0.2	~6	800	100	190	~0.3	~8	640	120	235	~0.3	~10	510	90
Heat resistant alloy (INCO718) 35-43HRC	DS118 (JC7518) (DS150)	~80	~0.8	~6	600	110	~100	~1	~8	480	130	~120	~1	~10	380	110
		120	~0.4	~6	500	70	150	~0.5	~8	400	80	190	~0.5	~10	320	80
		160	~0.2	~6	400	40	190	~0.3	~8	320	50	235	~0.3	~10	250	50

Note

1. Please adjust cutting conditions according to machine rigidity or work rigidity.
2. In case of chatter occurring, recommended to reduce a_p or rpm and keep feed per tooth.
3. a_p should be reduced when using on low rigidity machine.
4. Use air blow.
5. In case of slotting, apply 50% or less feed (V_f) from standard cutting condition table.

EXTREME SAP

EXSAP/MSX Type

■ Recommended cutting conditions

■ **EXSAP-11 Type**

■ Modular head type / Face milling

Material	Grade	Tool dia.(mm)									
		30/32/33/35					40				
		4N					5N				
		ℓ (mm)	a_p (mm)	a_e (mm)	n (min ⁻¹)	V_f (mm/min)	ℓ (mm)	a_p (mm)	a_e (mm)	n (min ⁻¹)	V_f (mm/min)
Carbon steel (S50C, S55C) below 250HB	JC8050 (JC8118)	~160	~1.5	~18	1,590	1,020	~160	~1.6	~24	1,430	1,290
		240	~0.8	~18	1,380	720	240	~1	~24	1,270	950
		290	~0.3	~18	1,170	470	290	~0.4	~24	1,110	670
Cast steel (GM190, ICD5) below 285HB	JC8050 (JC8118)	~160	~1.5	~18	1,590	1,020	~160	~1.6	~24	1,430	1,290
		240	~0.8	~18	1,380	720	240	~1	~24	1,270	950
		290	~0.3	~18	1,170	470	290	~0.4	~24	1,110	670
Tool & die steel (SKD61, SKD11) below 255HB	JC8050 (JC8118)	~160	~1.5	~18	1,590	1,020	~160	~1.6	~24	1,430	1,290
		240	~0.8	~18	1,380	720	240	~1	~24	1,270	950
		290	~0.3	~18	1,170	470	290	~0.4	~24	1,110	670
Mold steel (HPM7, PX5, P20) 30-36 HRC	JC8118 (JC8050)	~160	~1.5	~18	1,380	830	~160	~1.6	~24	1,030	820
		240	~0.8	~18	1,270	610	240	~1	~24	950	620
		290	~0.3	~18	1,170	420	290	~0.4	~24	880	440
Mold steel (NAK80, HPM1, P21) 38-43HRC	JC8118 (JC8050)	~160	~1.2	~18	1,170	660	~160	~1.4	~24	950	710
		240	~0.6	~18	1,060	470	240	~0.8	~24	840	500
		290	~0.3	~18	950	300	290	~0.4	~24	720	320
Hardened die steel (SKD61, DAC, DHA) 42-52HRC	JC8118	~160	~0.6	~12	950	380	~160	~0.8	~16	800	440
		240	~0.4	~12	850	270	240	~0.4	~16	720	320
		290	~0.2	~12	740	180	290	~0.2	~16	640	220
Grey cast iron (FC250) 160-260HB	JC8118 (JC8050)	~160	~1.5	~18	1,910	1,220	~160	~1.6	~24	1,590	1,430
		240	~0.8	~18	1,700	880	240	~1	~24	1,430	1,070
		290	~0.3	~18	1,490	600	290	~0.4	~24	1,270	760
Nodular cast iron (FCD700) 170-300HB	JC8118 (JC8050)	~160	~1.5	~18	1,490	950	~160	~1.6	~24	1,430	1,290
		240	~0.8	~18	1,380	720	240	~1	~24	1,270	950
		290	~0.3	~18	1,270	510	290	~0.4	~24	1,110	670
Austenitic stainless steel (SUS304, 316, 317) 17Cr	JC8050 (JC7550)	~160	~1.5	~12	1,170	750	~160	~1.6	~16	950	860
		240	~0.8	~12	1,060	550	240	~1	~16	880	660
		290	~0.3	~12	950	380	290	~0.4	~16	800	480
Ferritic & martensitic stainless steel (SUS403, 420J2, 430) 13Cr	JC8050 (JC7550)	~160	~1.5	~18	1,590	1,020	~160	~1.6	~24	1,110	1,000
		240	~0.8	~18	1,380	720	240	~1	~24	950	710
		290	~0.3	~18	1,170	470	290	~0.4	~24	800	480
Titanium alloy (Ti-6Al-4V) 35-43HRC	DS150 (JC7550) (DS118)	~160	~0.8	~12	640	260	~160	~1.4	~16	560	310
		240	~0.5	~12	530	170	240	~0.8	~16	480	220
		290	~0.2	~12	420	100	290	~0.3	~16	400	140
Heat resistant alloy (INCO718) 35-43HRC	DS118 (JC7518) (DS150)	~160	~0.8	~12	320	130	~160	~1.4	~16	240	120
		240	~0.5	~12	270	90	240	~0.8	~16	200	80
		290	~0.2	~12	210	50	290	~0.3	~16	160	50

Note

1. Please adjust cutting conditions according to machine rigidity or work rigidity.
2. In case of chatter occurring, recommended to reduce a_p or rpm and keep feed per tooth.
3. a_p should be reduced when using on low rigidity machine.
4. Use air blow.
5. In case of slotting , apply 50% or less feed (V_f) from standard cutting condition table.

EXTREME SAP**EXSAP/MSX Type**

■ Recommended cutting conditions

■ **EXSAP-17 Type**

■ Facemill type / Side milling

Material	Grade	Tool dia.(mm)														
		50					50/52					63				
		4N					5N					5N				
		ℓ (mm)	a _p (mm)	a _p ×a _e (mm ²)	n (min ⁻¹)	V _f (mm/min)	ℓ (mm)	a _p (mm)	a _p ×a _e (mm ²)	n (min ⁻¹)	V _f (mm/min)	ℓ (mm)	a _p (mm)	a _p ×a _e (mm ²)	n (min ⁻¹)	V _f (mm/min)
Carbon steel (S50C, S55C) below 250HB	JC8050	~100	~15	~40	1,270	1,520	~100	~15	~40	1,270	1,910	~100	~15	~45	1,010	1,770
		150	~12	~25	1,150	1,150	150	~12	~25	1,150	1,440	150	~12	~30	910	1,370
		200	~10	~15	1,020	820	200	~10	~15	1,020	1,020	200	~10	~20	810	1,010
Cast steel (GM190, ICD5) below 285HB	JC8050	~100	~15	~40	1,150	1,380	~100	~15	~40	1,150	1,730	~100	~15	~45	910	1,590
		150	~12	~25	1,020	1,020	150	~12	~25	1,020	1,280	150	~12	~30	810	1,220
		200	~10	~15	890	710	200	~10	~15	890	890	200	~10	~20	710	890
Tool & die steel (SKD61, SKD11) below 255HB	JC8050	~100	~15	~40	1,270	1,520	~100	~15	~40	1,270	1,910	~100	~15	~45	1,010	1,770
		150	~12	~25	1,150	1,150	150	~12	~25	1,150	1,440	150	~12	~30	910	1,370
		200	~10	~15	1,020	820	200	~10	~15	1,020	1,020	200	~10	~20	810	1,010
Mold steel (HPM7, PX5, P20) 30-36 HRC	JC8118	~100	~15	~40	950	1,140	~100	~15	~40	950	1,430	~100	~15	~45	760	1,330
		150	~12	~25	860	860	150	~12	~25	860	1,080	150	~12	~30	680	1,020
		200	~10	~15	760	610	200	~10	~15	760	760	200	~10	~20	610	760
Mold steel (NAK80, HPM1, P21) 38-43HRC	JC8118	~100	~15	~30	760	760	~100	~15	~30	760	950	~100	~15	~30	610	760
		150	~12	~20	670	540	150	~12	~20	670	670	150	~12	~25	530	530
		200	~10	~12	570	340	200	~10	~12	570	430	200	~10	~15	450	340
Hardened die steel (SKD61, DAC, DHA) 42-52HRC	JC8118	~100	~15	~18	640	510	~100	~15	~18	640	640	~100	~15	~25	510	510
		150	~12	~12	570	340	150	~12	~12	570	430	150	~12	~15	450	340
		200	~10	~5	510	200	200	~10	~5	510	260	200	~10	~8	400	200
Grey cast iron (FC250) 160-260HB	JC8118	~100	~15	~40	1,590	1,910	~100	~15	~40	1,590	2,390	~100	~15	~45	1,260	2,210
		150	~12	~25	1,460	1,460	150	~12	~25	1,460	1,830	150	~12	~30	1,160	1,740
		200	~10	~15	1,340	1,070	200	~10	~15	1,340	1,340	200	~10	~20	1,060	1,330
Nodular cast iron (FCD700) 170-300HB	JC8118	~100	~15	~40	950	950	~100	~15	~40	950	1,190	~100	~15	~45	760	1,140
		150	~12	~25	830	660	150	~12	~25	830	830	150	~12	~30	660	830
		200	~10	~15	700	420	200	~10	~15	700	530	200	~10	~20	560	560
Austenitic stainless steel (SUS304, 316, 317) 17Cr	JC8050	~100	~15	~40	760	610	~100	~15	~40	760	760	~100	~15	~45	610	610
		150	~12	~25	700	420	150	~12	~25	700	530	150	~12	~30	560	420
		200	~10	~15	640	260	200	~10	~15	640	320	200	~10	~20	510	260
Ferritic & martensitic stainless steel (SUS403, 420J2, 430) 13Cr	JC8118	~100	~15	~40	1,150	1,150	~100	~15	~40	1,150	1,440	~100	~15	~45	910	1,370
		150	~12	~25	1,020	820	150	~12	~25	1,020	1,020	150	~12	~30	810	1,010
		200	~10	~15	890	530	200	~10	~15	890	670	200	~10	~20	710	710

Note

1. Please adjust cutting conditions according to machine rigidity or work rigidity.
2. In case of chatter occurring, recommended to reduce a_p or rpm and keep feed per tooth.
3. a_p should be reduced when using on low rigidity machine.
4. Use air blow.

EXTREME SAP

EXSAP/MSX Type

■ Recommended cutting conditions

■ **EXSAP-17 Type**

■ Facemill type / Side milling

Material	Grade	Tool dia.(mm)														
		80					100					125				
		7N					7N					8N				
		ℓ (mm)	ap (mm)	ap×ae (mm ²)	n (min ⁻¹)	Vf (mm/min)	ℓ (mm)	ap (mm)	ap×ae (mm ²)	n (min ⁻¹)	Vf (mm/min)	ℓ (mm)	ap (mm)	ap×ae (mm ²)	n (min ⁻¹)	Vf (mm/min)
Carbon steel (S50C, S55C) below 250HB	JC8050	~100	~15	~45	800	1,960	~100	~15	~45	640	1,570	~100	~15	~45	510	1,430
		150	~12	~30	720	1,510	150	~12	~30	570	1,200	150	~12	~30	460	1,100
		200	~10	~20	640	1,120	200	~10	~20	510	890	200	~10	~20	410	820
Cast steel (GM190, ICD5) below 285HB	JC8050	~100	~15	~45	720	1,760	~100	~15	~45	570	1,400	~100	~15	~45	460	1,290
		150	~12	~30	640	1,340	150	~12	~30	510	1,070	150	~12	~30	410	980
		200	~10	~20	560	980	200	~10	~20	450	790	200	~10	~20	360	720
Tool & die steel (SKD61, SKD11) below 255HB	JC8050	~100	~15	~45	800	1,960	~100	~15	~45	640	1,570	~100	~15	~45	510	1,430
		150	~12	~30	720	1,510	150	~12	~30	570	1,200	150	~12	~30	460	1,100
		200	~10	~20	640	1,120	200	~10	~20	510	890	200	~10	~20	410	820
Mold steel (HPM7, PX5, P20) 30-36 HRC	JC8118	~100	~15	~45	600	1,470	~100	~15	~45	480	1,180	~100	~15	~45	380	1,060
		150	~12	~30	540	1,130	150	~12	~30	430	900	150	~12	~30	340	820
		200	~10	~20	480	840	200	~10	~20	380	670	200	~10	~20	310	620
Mold steel (NAK80, HPM1, P21) 38-43HRC	JC8118	~100	~15	~30	480	840	~100	~15	~30	380	670	~100	~15	~30	310	620
		150	~12	~25	420	590	150	~12	~25	330	460	150	~12	~25	270	430
		200	~10	~15	360	380	200	~10	~15	290	300	200	~10	~15	230	280
Hardened die steel (SKD61, DAC, DHA) 42-52HRC	JC8118	~100	~15	~25	400	560	~100	~15	~25	320	450	~100	~15	~25	250	400
		150	~12	~15	360	380	150	~12	~15	290	300	150	~12	~15	230	280
		200	~10	~8	320	220	200	~10	~8	250	180	200	~10	~8	200	160
Grey cast iron (FC250) 160-260HB	JC8118	~100	~15	~45	990	2,430	~100	~15	~45	800	1,960	~100	~15	~45	640	1,790
		150	~12	~30	920	1,930	150	~12	~30	730	1,530	150	~12	~30	590	1,420
		200	~10	~20	840	1,470	200	~10	~20	670	1,170	200	~10	~20	530	1,060
Nodular cast iron (FCD700) 170-300HB	JC8118	~100	~15	~45	600	1,260	~100	~15	~45	480	1,010	~100	~15	~45	380	910
		150	~12	~30	520	910	150	~12	~30	410	720	150	~12	~30	330	660
		200	~10	~20	440	620	200	~10	~20	350	490	200	~10	~20	280	450
Austenitic stainless steel (SUS304, 316, 317) 17Cr	JC8050	~100	~15	~45	480	670	~100	~15	~45	380	530	~100	~15	~45	310	500
		150	~12	~30	440	460	150	~12	~30	350	370	150	~12	~30	280	340
		200	~10	~20	400	280	200	~10	~20	320	220	200	~10	~20	250	200
Ferritic & martensitic stainless steel (SUS403, 420J2, 430) 13Cr	JC8118	~100	~15	~45	720	1,510	~100	~15	~45	570	1,200	~100	~15	~45	460	1,100
		150	~12	~30	640	1,120	150	~12	~30	510	890	150	~12	~30	410	820
		200	~10	~20	560	780	200	~10	~20	450	630	200	~10	~20	360	580

Note

1. Please adjust cutting conditions according to machine rigidity or work rigidity.
2. In case of chatter occurring, recommended to reduce ap or rpm and keep feed per tooth.
3. ap should be reduced when using on low rigidity machine.
4. Use air blow.

EXTREME SAP**EXSAP/MSX Type**

■ Recommended cutting conditions

■ **EXSAP-17 Type**

■ Endmill type / Side milling

Material	Grade	Tool dia.(mm)									
		25					32				
		2N					2N				
		ℓ (mm)	a_p (mm)	$a_p \times a_e$ (mm ²)	n (min ⁻¹)	V_f (mm/min)	ℓ (mm)	a_p (mm)	$a_p \times a_e$ (mm ²)	n (min ⁻¹)	V_f (mm/min)
Carbon steel (S50C, S55C) below 250HB	JC8050	~60	~10	~15	2,550	1,530	~70	~12	~24	1,990	1,190
		90	~7	~10	2,290	1,150	100	~9	~18	1,790	900
Cast steel (GM190, ICD5) below 285HB	JC8050	~60	~10	~15	2,290	1,370	~70	~12	~24	1,790	1,070
		90	~7	~10	2,040	1,020	100	~9	~18	1,590	800
Tool & die steel (SKD61, SKD11) below 255HB	JC8050	~60	~10	~15	2,550	1,530	~70	~12	~24	1,990	1,190
		90	~7	~10	2,290	1,150	100	~9	~18	1,790	900
Mold steel (HPM7, PX5, P20) 30-36 HRC	JC8118	~60	~10	~15	1,910	1,150	~70	~12	~24	1,490	890
		90	~7	~10	1,720	860	100	~9	~18	1,340	670
Mold steel (NAK80, HPM1, P21) 38-43HRC	JC8118	~60	~10	~12	1,530	770	~70	~12	~18	1,190	600
		90	~7	~6	1,340	540	100	~9	~13	1,040	420
Hardened die steel (SKD61, DAC, DHA) 42-52HRC	JC8118	~60	~10	~8	1,270	510	~70	~12	~12	990	400
		90	~7	~4	1,150	350	100	~9	~8	900	270
Grey cast iron (FC250) 160-260HB	JC8118	~60	~10	~15	3,180	1,910	~70	~12	~24	2,490	1,490
		90	~7	~10	2,930	1,470	100	~9	~18	2,290	1,150
Nodular cast iron (FCD700) 170-300HB	JC8118	~60	~10	~15	1,910	960	~70	~12	~24	1,490	750
		90	~7	~10	1,660	660	100	~9	~18	1,290	520
Austenitic stainless steel (SUS304, 316, 317) 17Cr	JC8050	~60	~10	~15	1,530	610	~70	~12	~24	1,190	480
		90	~7	~10	1,400	420	100	~9	~18	1,090	330
Ferritic & martensitic stainless steel (SUS403, 420J2, 430) 13Cr	JC8118	~60	~10.0	~15	2,290	1,150	~70	~12	~24	1,790	900
		90	~7.0	~10	2,040	820	100	~9	~18	1,590	640

Note

1. Please adjust cutting conditions according to machine rigidity or work rigidity.
2. In case of chatter occurring, recommended to reduce a_p or rpm and keep feed per tooth.
3. a_p should be reduced when using on low rigidity machine.
4. Use air blow.

EXTREME SAP**EXSAP/MSX Type**

■ Recommended cutting conditions

■ **EXSAP-17 Type**

■ Endmill type / Side milling

Material	Grade	Tool dia.(mm)				
		32				
		3N				
		ϕ (mm)	a_p (mm)	$a_p \times a_e$ (mm ²)	n (min ⁻¹)	V_f (mm/min)
Carbon steel (S50C, S55C) below 250HB	JC8050	~70	~12	~24	1,990	1,790
		100	~9	~18	1,790	1,340
Cast steel (GM190, ICD5) below 285HB	JC8050	~70	~12	~24	1,790	1,610
		100	~9	~18	1,590	1,190
Tool & die steel (SKD61, SKD11) below 255HB	JC8050	~70	~12	~24	1,990	1,790
		100	~9	~18	1,790	1,340
Mold steel (HPM7, PX5, P20) 30-36 HRC	JC8118	~70	~12	~24	1,490	1,340
		100	~9	~18	1,340	1,010
Mold steel (NAK80, HPM1, P21) 38-43HRC	JC8118	~70	~12	~18	1,190	890
		100	~9	~13	1,040	620
Hardened die steel (SKD61, DAC, DHA) 42-52HRC	JC8118	~70	~12	~12	990	590
		100	~9	~8	900	410
Grey cast iron (FC250) 160-260HB	JC8118	~70	~12	~24	2,490	2,240
		100	~9	~18	2,290	1,720
Nodular cast iron (FCD700) 170-300HB	JC8118	~70	~12	~24	1,490	1,120
		100	~9	~18	1,290	770
Austenitic stainless steel (SUS304, 316, 317) 17Cr	JC8050	~70	~12	~24	1,190	710
		100	~9	~18	1,090	490
Ferritic & martensitic stainless steel (SUS403, 420J2, 430) 13Cr	JC8118	~70	~12	~24	1,790	1,340
		100	~9	~18	1,590	950

Note

1. Please adjust cutting conditions according to machine rigidity or work rigidity.
2. In case of chatter occurring, recommended to reduce a_p or rpm and keep feed per tooth.
3. a_p should be reduced when using on low rigidity machine.
4. Use air blow.

EXTREME SAP**EXSAP/MSX Type**

■ Recommended cutting conditions

■ **EXSAP-17 Type**

■ Modular head type / Side milling

Material	Grade	Tool dia.(mm)									
		25/26/28					30/32				
		2N					2N				
		ℓ (mm)	a_p (mm)	$a_p \times a_e$ (mm ²)	n (min ⁻¹)	V_f (mm/min)	ℓ (mm)	a_p (mm)	$a_p \times a_e$ (mm ²)	n (min ⁻¹)	V_f (mm/min)
Carbon steel (S50C, S55C) below 250HB	JC8050	~90	~10	~15	2,450	1,470	~100	~12	~24	2,050	1,230
		140	~7	~10	2,200	1,100	150	~9	~18	1,850	930
		210	~4	~5	1,960	780	210	~6	~9	1,640	660
Cast steel (GM190, ICD5) below 285HB	JC8050	~90	~10	~15	2,200	1,320	~100	~12	~24	1,850	1,110
		140	~7	~10	1,960	980	150	~9	~18	1,640	820
		210	~4	~5	1,710	680	210	~6	~9	1,440	580
Tool & die steel (SKD61, SKD11) below 255HB	JC8050	~90	~10	~15	2,450	1,470	~100	~12	~24	2,050	1,230
		140	~7	~10	2,200	1,100	150	~9	~18	1,850	930
		210	~4	~5	1,960	780	210	~6	~9	1,640	660
Mold steel (HPM7, PX5, P20) 30-36 HRC	JC8118	~90	~10	~15	1,840	1,100	~100	~12	~24	1,540	920
		140	~7	~10	1,650	830	150	~9	~18	1,390	700
		210	~4	~5	1,470	590	210	~6	~9	1,230	490
Mold steel (NAK80, HPM1, P21) 38-43HRC	JC8118	~90	~10	~12	1,470	740	~100	~12	~18	1,230	620
		140	~7	~6	1,290	520	150	~9	~13	1,080	430
		210	~4	~2	1,100	330	210	~6	~7	920	280
Hardened die steel (SKD61, DAC, DHA) 42-52HRC	JC8118	~90	~10	~8	1,220	490	~100	~12	~12	1,030	410
		140	~7	~4	1,100	330	150	~9	~8	920	280
		210	~4	~2	980	200	210	~6	~3	820	160
Grey cast iron (FC250) 160-260HB	JC8118	~90	~10	~15	3,060	1,840	~100	~12	~24	2,570	1,540
		140	~7	~10	2,820	1,410	150	~9	~18	2,360	1,180
		210	~4	~5	2,570	1,030	210	~6	~12	2,160	860
Nodular cast iron (FCD700) 170-300HB	JC8118	~90	~10	~15	1,840	920	~100	~12	~24	1,540	770
		140	~7	~10	1,590	640	150	~9	~18	1,330	530
		210	~4	~5	1,350	410	210	~6	~9	1,130	340
Austenitic stainless steel (SUS304, 316, 317) 17Cr	JC8050	~90	~10	~15	1,470	590	~100	~12	~24	1,230	490
		140	~7	~10	1,350	410	150	~9	~18	1,130	340
		210	~4	~5	1,220	240	210	~6	~9	1,030	210
Ferritic & martensitic stainless steel (SUS403, 420J2, 430) 13Cr	JC8118	~90	~10	~15	2,200	1,100	~100	~12	~24	1,850	930
		140	~7	~10	1,960	780	150	~9	~18	1,640	660
		210	~4	~5	1,710	510	210	~6	~9	1,440	430

Note

1. Please adjust cutting conditions according to machine rigidity or work rigidity.
2. In case of chatter occurring, recommended to reduce a_p or rpm and keep feed per tooth.
3. a_p should be reduced when using on low rigidity machine.
4. Use air blow.

EXTREME SAP
EXSAP/MSX Type
Recommended cutting conditions
EXSAP-17 Type
Modular head type / Side milling

Material	Grade	Tool dia.(mm)									
		32/33/35					40				
		3N					4N				
		l (mm)	a_p (mm)	$a_p \times a_e$ (mm ²)	n (min ⁻¹)	V_f (mm/min)	l (mm)	a_p (mm)	$a_p \times a_e$ (mm ²)	n (min ⁻¹)	V_f (mm/min)
Carbon steel (S50C, S55C) below 250HB	JC8050	~100	~12	~24	1,930	1,740	~100	~15	~30	1,590	1,910
		150	~9	~18	1,740	1,310	150	~10	~20	1,430	1,430
		210	~6	~9	1,540	920	210	~8	~12	1,270	1,020
Cast steel (GM190, ICD5) below 285HB	JC8050	~100	~12	~24	1,740	1,570	~100	~15	~30	1,430	1,720
		150	~9	~18	1,540	1,160	150	~10	~20	1,270	1,270
		210	~6	~9	1,350	810	210	~8	~12	1,110	890
Tool & die steel (SKD61, SKD11) below 255HB	JC8050	~100	~12	~24	1,930	1,740	~100	~15	~30	1,590	1,910
		150	~9	~18	1,740	1,310	150	~10	~20	1,430	1,430
		210	~6	~9	1,540	920	210	~8	~12	1,270	1,020
Mold steel (HPM7, PX5, P20) 30-36 HRC	JC8118	~100	~12	~24	1,450	1,310	~100	~15	~30	1,190	1,430
		150	~9	~18	1,300	980	150	~10	~20	1,070	1,070
		210	~6	~9	1,160	700	210	~8	~12	950	760
Mold steel (NAK80, HPM1, P21) 38-43HRC	JC8118	~100	~12	~18	1,160	870	~100	~15	~20	950	950
		150	~9	~13	1,010	610	150	~10	~15	840	670
		210	~6	~7	870	390	210	~8	~8	720	430
Hardened die steel (SKD61, DAC, DHA) 42-52HRC	JC8118	~100	~12	~12	960	580	~100	~12	~12	800	640
		150	~9	~8	870	390	150	~10	~8	720	430
		210	~6	~3	770	230	210	~8	~3	640	260
Grey cast iron (FC250) 160-260HB	JC8118	~100	~12	~24	2,410	2,170	~100	~15	~30	1,990	2,390
		150	~9	~18	2,220	1,670	150	~10	~20	1,830	1,830
		210	~6	~12	2,030	1,220	210	~8	~16	1,670	1,340
Nodular cast iron (FCD700) 170-300HB	JC8118	~100	~12	~24	1,450	1,090	~100	~15	~30	1,190	1,190
		150	~9	~18	1,250	750	150	~10	~20	1,030	820
		210	~6	~9	1,060	480	210	~8	~12	880	530
Austenitic stainless steel (SUS304, 316, 317) 17Cr	JC8050	~100	~12	~24	1,160	700	~100	~15	~30	950	760
		150	~9	~18	1,060	480	150	~10	~20	880	530
		210	~6	~9	960	290	210	~8	~12	800	320
Ferritic & martensitic stainless steel (SUS403, 420J2, 430) 13Cr	JC8118	~100	~12	~24	1,740	1,310	~100	~15	~30	1,430	1,430
		150	~9	~18	1,540	920	150	~10	~20	1,270	1,020
		210	~6	~9	1,350	610	210	~8	~12	1,110	670

Note

1. Please adjust cutting conditions according to machine rigidity or work rigidity.
2. In case of chatter occurring, recommended to reduce a_p or rpm and keep feed per tooth.
3. a_p should be reduced when using on low rigidity machine.
4. Use air blow.

EXTREME SAP**EXSAP/MSX Type**

■ Recommended cutting conditions

■ **EXSAP-17 Type**

■ Facemill type / Face milling

Material	Grade	Tool dia.(mm)														
		50					50/52					63				
		4N					5N					5N				
		ℓ (mm)	a_p (mm)	a_e (mm)	n (min ⁻¹)	V_f (mm/min)	ℓ (mm)	a_p (mm)	a_e (mm)	n (min ⁻¹)	V_f (mm/min)	ℓ (mm)	a_p (mm)	a_e (mm)	n (min ⁻¹)	V_f (mm/min)
Carbon steel (S50C, S55C) below 250HB	JC8050	~150	~4	~50	950	1,140	~150	~4	~1Dc	950	1,430	~150	~4	~63	760	1,330
		200	~3	~40	830	830	200	~3	~40	830	1,040	200	~3	~55	660	990
		300	~2	~30	700	560	300	~2	~30	700	700	300	~2	~40	560	700
Cast steel (GM190, ICD5) below 285HB	JC8050	~150	~4	~50	950	1,140	~150	~4	~1Dc	950	1,430	~150	~4	~63	760	1,330
		200	~3	~40	830	830	200	~3	~40	830	1,040	200	~3	~55	660	990
		300	~2	~30	700	560	300	~2	~30	700	700	300	~2	~40	560	700
Tool & die steel (SKD61, SKD11) below 255HB	JC8050	~150	~4	~50	950	950	~150	~4	~1Dc	950	1,190	~150	~4	~63	760	1,140
		200	~3	~40	830	660	200	~3	~40	830	830	200	~3	~55	660	830
		300	~2	~30	700	420	300	~2	~30	700	530	300	~2	~40	560	560
Mold steel (HPM7, PX5, P20) 30-36 HRC	JC8118	~150	~4	~50	830	830	~150	~4	~1Dc	830	1,040	~150	~4	~63	660	990
		200	~3	~40	760	610	200	~3	~40	760	760	200	~3	~55	610	760
		300	~2	~30	700	420	300	~2	~30	700	530	300	~2	~40	560	560
Mold steel (NAK80, HPM1, P21) 38-43HRC	JC8118	~150	~3	~50	700	700	~150	~3	~1Dc	700	880	~150	~3	~63	560	700
		200	~2.5	~40	640	510	200	~2.5	~40	640	640	200	~2.5	~55	510	510
		300	~1.5	~30	570	340	300	~1.5	~30	570	430	300	~1.5	~40	450	340
Hardened die steel (SKD61, DAC, DHA) 42-52HRC	JC8118	~150	~2.5	~40	570	460	~150	~2.5	~40	570	570	~150	~2.5	~55	450	450
		200	~2	~30	510	310	200	~2	~30	510	380	200	~2	~40	400	300
		300	~1.5	~20	450	180	300	~1.5	~20	450	230	300	~1.5	~32	350	180
Grey cast iron (FC250) 160-260HB	JC8118	~150	~6	~50	1,150	1,380	~150	~6	~1Dc	1,150	1,730	~150	~6	~63	910	1,590
		200	~4	~40	950	950	200	~4	~40	950	1,190	200	~4	~55	760	1,140
		300	~2	~30	830	660	300	~2	~30	830	830	300	~2	~40	660	830
Nodular cast iron (FCD700) 170-300HB	JC8118	~150	~4	~50	830	830	~150	~4	~1Dc	830	1,040	~150	~4	~63	660	990
		200	~3	~40	760	610	200	~3	~40	760	760	200	~3	~55	610	760
		300	~2	~30	700	420	300	~2	~30	700	530	300	~2	~40	560	560
Austenitic stainless steel (SUS304, 316, 317) 17Cr	JC8050	~150	~4	~40	700	560	~150	~4	~40	700	700	~150	~4	~55	560	560
		200	~3	~30	640	380	200	~3	~30	640	480	200	~3	~40	510	380
		300	~2	~20	570	230	300	~2	~20	570	290	300	~2	~32	450	230
Ferritic & martensitic stainless steel (SUS403, 420J2, 430) 13Cr	JC8118	~150	~4	~50	950	950	~150	~4	~1Dc	950	1,190	~150	~4	~63	760	1,140
		200	~3	~40	830	660	200	~3	~40	830	830	200	~3	~55	660	830
		300	~2	~30	700	420	300	~2	~30	700	530	300	~2	~40	560	560

Note

1. Please adjust cutting conditions according to machine rigidity or work rigidity.
2. In case of chatter occurring, recommended to reduce a_p or rpm and keep feed per tooth.
3. a_p should be reduced when using on low rigidity machine.
4. Use air blow.
5. In case of slotting, apply 50% or less feed (V_f) from standard cutting condition table.

EXTREME SAP

EXSAP/MSX Type

■ Recommended cutting conditions

■ **EXSAP-17 Type**

■ Facemill type / Face milling

Material	Grade	Tool dia.(mm)														
		80					100					125				
		7N					7N					8N				
		ℓ (mm)	ap (mm)	ae (mm)	n (min ⁻¹)	Vf (mm/min)	ℓ (mm)	ap (mm)	ae (mm)	n (min ⁻¹)	Vf (mm/min)	ℓ (mm)	ap (mm)	ae (mm)	n (min ⁻¹)	Vf (mm/min)
Carbon steel (S50C, S55C) below 250HB	JC8050	~150	~4	~80	600	1,470	~150	~4	~100	480	1,010	~150	~4	~125	380	910
		200	~3	~65	520	1,090	200	~3	~80	410	720	200	~3	~100	330	660
		300	~2	~50	440	770	300	~2	~60	350	490	300	~2	~75	280	450
Cast steel (GM190, ICD5) below 285HB	JC8050	~150	~4	~80	600	1,470	~150	~4	~100	480	1,010	~150	~4	~125	380	910
		200	~3	~65	520	1,090	200	~3	~80	410	720	200	~3	~100	330	660
		300	~2	~50	440	770	300	~2	~60	350	490	300	~2	~75	280	450
Tool & die steel (SKD61, SKD11) below 255HB	JC8050	~150	~4	~80	600	1,260	~150	~4	~100	480	840	~150	~4	~125	380	760
		200	~3	~65	520	910	200	~3	~80	410	570	200	~3	~100	330	530
		300	~2	~50	440	620	300	~2	~60	350	370	300	~2	~75	280	340
Mold steel (HPM7, PX5, P20) 30-36 HRC	JC8118	~150	~4	~80	520	1,090	~150	~4	~100	410	720	~150	~4	~125	330	660
		200	~3	~65	480	840	200	~3	~80	380	530	200	~3	~100	310	500
		300	~2	~50	440	620	300	~2	~60	350	370	300	~2	~75	280	340
Mold steel (NAK80, HPM1, P21) 38-43HRC	JC8118	~150	~3	~80	440	770	~150	~4	~100	350	490	~150	~4	~125	280	450
		200	~2.5	~65	400	560	200	~3	~80	320	340	200	~3	~100	250	300
		300	~1.5	~50	360	380	300	~2	~60	290	200	300	~2	~75	230	180
Hardened die steel (SKD61, DAC, DHA) 42-52HRC	JC8118	~150	~2.5	~65	360	500	~150	~4	~80	290	300	~150	~4	~100	230	280
		200	~2.0	~50	320	340	200	~3	~60	250	180	200	~3	~75	200	160
		300	~1.5	~35	280	200	300	~2	~40	220	150	300	~2	~50	180	140
Grey cast iron (FC250) 160-260HB	JC8118	~150	~6	~80	720	1,760	~150	~4	~100	570	1,200	~150	~4	~125	460	1,100
		200	~4	~65	600	1,260	200	~3	~80	480	840	200	~3	~100	380	760
		300	~2	~50	520	910	300	~2	~60	410	570	300	~2	~75	330	530
Nodular cast iron (FCD700) 170-300HB	JC8118	~150	~4	~80	520	1,090	~150	~4	~100	410	720	~150	~4	~125	330	660
		200	~3	~65	480	840	200	~3	~80	380	530	200	~3	~100	310	500
		300	~2	~50	440	620	300	~2	~60	350	370	300	~2	~75	280	340
Austenitic stainless steel (SUS304, 316, 317) 17Cr	JC8050	~150	~4	~65	440	620	~150	~4	~80	350	370	~150	~4	~100	280	340
		200	~3	~50	400	420	200	~3	~60	320	220	200	~3	~75	250	200
		300	~2	~35	360	250	300	~2	~40	290	200	300	~2	~50	230	180
Ferritic & martensitic stainless steel (SUS403, 420J2, 430) 13Cr	JC8118	~150	~4	~80	600	1,260	~150	~4	~100	480	840	~150	~4	~125	380	760
		200	~3	~65	520	910	200	~3	~80	410	570	200	~3	~100	330	530
		300	~2	~50	440	620	300	~2	~60	350	370	300	~2	~75	280	340

Note

1. Please adjust cutting conditions according to machine rigidity or work rigidity.
2. In case of chatter occurring, recommended to reduce ap or rpm and keep feed per tooth.
3. ap should be reduced when using on low rigidity machine.
4. Use air blow.
5. In case of slotting , apply 50% or less feed (Vf) from standard cutting condition table.

EXTREME SAP**EXSAP/MSX Type**

■ Recommended cutting conditions

■ **EXSAP-17 Type**

■ Endmill type / Face milling

Material	Grade	Tool dia.(mm)									
		25					32				
		2N					2N				
		ϕ (mm)	a_p (mm)	a_e (mm)	n (min ⁻¹)	V_f (mm/min)	ϕ (mm)	a_p (mm)	a_e (mm)	n (min ⁻¹)	V_f (mm/min)
Carbon steel (S50C, S55C) below 250HB	JC8050	~60	~3	~1Dc	1,910	1,150	~70	~3.5	~1Dc	1,490	890
		90	~2	~20	1,660	830	100	~2.5	~25	1,290	650
Cast steel (GM190, ICD5) below 285HB	JC8050	~60	~3	~1Dc	1,910	1,150	~70	~3.5	~1Dc	1,490	890
		90	~2	~20	1,660	830	100	~2.5	~25	1,290	650
Tool & die steel (SKD61, SKD11) below 255HB	JC8050	~60	~3	~1Dc	1,910	960	~70	~3.5	~1Dc	1,490	750
		90	~2	~20	1,660	660	100	~2.5	~25	1,290	520
Mold steel (HPM7, PX5, P20) 30-36 HRC	JC8118	~60	~3	~1Dc	1,660	830	~70	~3.5	~1Dc	1,290	650
		90	~2	~20	1,530	610	100	~2.5	~25	1,190	480
Mold steel (NAK80, HPM1, P21) 38-43HRC	JC8118	~60	~2	~1Dc	1,400	700	~70	~2.5	~1Dc	1,090	550
		90	~1	~20	1,270	510	100	~2	~25	990	400
Hardened die steel (SKD61, DAC, DHA) 42-52HRC	JC8118	~60	~1	~20	1,150	460	~70	~2	~25	900	360
		90	~1	~15	1,020	310	100	~1.5	~20	800	240
Grey cast iron (FC250) 160-260HB	JC8118	~60	~5	~1Dc	2,550	1,530	~70	~5.5	~1Dc	1,990	1,190
		90	~3	~20	2,290	1,150	100	~3.5	~25	1,790	900
Nodular cast iron (FCD700) 170-300HB	JC8118	~60	~3	~1Dc	1,660	830	~70	~3.5	~1Dc	1,290	650
		90	~2	~20	1,530	610	100	~2.5	~25	1,190	480
Austenitic stainless steel (SUS304, 316, 317) 17Cr	JC8050	~60	~3	~20	1,400	560	~70	~3.5	~25	1,090	440
		90	~2	~15	1,270	380	100	~2.5	~20	990	300
Ferritic & martensitic stainless steel (SUS403, 420J2, 430) 13Cr	JC8118	~60	~3	~1Dc	1,910	960	~70	~3.5	~1Dc	1,490	750
		90	~2	~20	1,660	660	100	~2.5	~25	1,290	520

Note

1. Please adjust cutting conditions according to machine rigidity or work rigidity.
2. In case of chatter occurring, recommended to reduce a_p or rpm and keep feed per tooth.
3. a_p should be reduced when using on low rigidity machine.
4. Use air blow.
5. In case of slotting, apply 50% or less feed (V_f) from standard cutting condition table.

EXTREME SAP
EXSAP/MSX Type
Recommended cutting conditions
EXSAP-17 Type
Endmill type / Face milling

Material	Grade	Tool dia.(mm)				
		32				
		3N				
		ℓ (mm)	a_p (mm)	a_e (mm)	n (min^{-1})	V_f (mm/min)
Carbon steel (S50C, S55C) below 250HB	JC8050	~70	~3.5	~1Dc	1,490	1,340
		100	~2.5	~25	1,290	970
Cast steel (GM190, ICD5) below 285HB	JC8050	~70	~3.5	~1Dc	1,490	1,340
		100	~2.5	~25	1,290	970
Tool & die steel (SKD61, SKD11) below 255HB	JC8050	~70	~3.5	~1Dc	1,490	1,120
		100	~2.5	~25	1,290	770
Mold steel (HPM7, PX5, P20) 30-36 HRC	JC8118	~70	~3.5	~1Dc	1,290	970
		100	~2.5	~25	1,190	710
Mold steel (NAK80, HPM1, P21) 38-43HRC	JC8118	~70	~2.5	~1Dc	1,090	820
		100	~2	~25	990	590
Hardened die steel (SKD61, DAC, DHA) 42-52HRC	JC8118	~70	~2	~25	900	540
		100	~1.5	~20	800	360
Grey cast iron (FC250) 160-260HB	JC8118	~70	~5.5	~1Dc	1,990	1,790
		100	~3.5	~25	1,790	1,340
Nodular cast iron (FCD700) 170-300HB	JC8118	~70	~3.5	~1Dc	1,290	970
		100	~2.5	~25	1,190	710
Austenitic stainless steel (SUS304, 316, 317) 17Cr	JC8050	~70	~3.5	~25	1,090	650
		100	~2.5	~20	990	450
Ferritic & martensitic stainless steel (SUS403, 420J2, 430) 13Cr	JC8118	~70	~3.5	~1Dc	1,490	1,120
		100	~2.5	~25	1,290	770

Note

1. Please adjust cutting conditions according to machine rigidity or work rigidity.
2. In case of chatter occurring, recommended to reduce a_p or rpm and keep feed per tooth.
3. a_p should be reduced when using on low rigidity machine.
4. Use air blow.
5. In case of slotting, apply 50% or less feed (V_f) from standard cutting condition table.

EXTREME SAP**EXSAP/MSX Type**

■ Recommended cutting conditions

■ **EXSAP-17 Type**

■ Modular head type / Face milling

Material	Grade	Tool dia.(mm)									
		25/26/28					30/32				
		2N					2N				
		ℓ (mm)	a_p (mm)	a_e (mm)	n (min ⁻¹)	V_f (mm/min)	ℓ (mm)	a_p (mm)	a_e (mm)	n (min ⁻¹)	V_f (mm/min)
Carbon steel (S50C, S55C) below 250HB	JC8050	~90	~3	~1Dc	1,840	1,100	~100	~3.5	~1Dc	1,540	920
		140	~2	~20	1,590	800	150	~2.5	~25	1,330	670
		210	~1	~15	1,350	540	210	~1.5	~20	1,130	450
Cast steel (GM190, ICD5) below 285HB	JC8050	~90	~3	~1Dc	1,840	1,100	~100	~3.5	~1Dc	1,540	920
		140	~2	~20	1,590	800	150	~2.5	~25	1,330	670
		210	~1	~15	1,350	540	210	~1.5	~20	1,130	450
Tool & die steel (SKD61, SKD11) below 255HB	JC8050	~90	~3	~1Dc	1,840	920	~100	~3.5	~1Dc	1,540	770
		140	~2	~20	1,590	640	150	~2.5	~25	1,330	530
		210	~1	~15	1,350	410	210	~1.5	~20	1,130	340
Mold steel (HPM7, PX5, P20) 30-36 HRC	JC8118	~90	~3	~1Dc	1,590	800	~100	~3.5	~1Dc	1,330	670
		140	~2	~20	1,470	590	150	~2.5	~25	1,230	490
		210	~1	~15	1,350	410	210	~1.5	~20	1,130	340
Mold steel (NAK80, HPM1, P21) 38-43HRC	JC8118	~90	~2	~1Dc	1,350	680	~100	~2.5	~1Dc	1,130	570
		140	~1.5	~20	1,220	490	150	~2	~25	1,030	410
		210	~1	~15	1,100	330	210	~1.5	~20	920	280
Hardened die steel (SKD61, DAC, DHA) 42-52HRC	JC8118	~90	~1.5	~20	1,100	440	~100	~2	~25	920	370
		140	~1	~15	980	290	150	~1.5	~20	820	250
		210	~0.5	~10	860	170	210	~1	~15	720	140
Grey cast iron (FC250) 160-260HB	JC8118	~90	~5	~1Dc	2,450	1,470	~100	~5.5	~1Dc	2,050	1,230
		140	~3	~20	2,200	1,100	150	~3.5	~25	1,850	930
		210	~1	~15	1,960	780	210	~1.5	~20	1,640	660
Nodular cast iron (FCD700) 170-300HB	JC8118	~90	~3	~1Dc	1,590	800	~100	~3.5	~1Dc	1,330	670
		140	~2	~20	1,470	590	150	~2.5	~25	1,230	490
		210	~1	~15	1,350	410	210	~1.5	~20	1,130	340
Austenitic stainless steel (SUS304, 316, 317) 17Cr	JC8050	~90	~3	~20	1,350	540	~100	~3.5	~25	1,130	450
		140	~2	~15	1,220	370	150	~2.5	~20	1,030	310
		210	~1	~10	1,100	220	210	~1.5	~15	920	180
Ferritic & martensitic stainless steel (SUS403, 420J2, 430) 13Cr	JC8118	~90	~3	~1Dc	1,840	920	~100	~3.5	~1Dc	1,540	770
		140	~2	~20	1,590	640	150	~2.5	~25	1,330	530
		210	~1	~15	1,350	410	210	~1.5	~20	1,130	340

Note

1. Please adjust cutting conditions according to machine rigidity or work rigidity.
2. In case of chatter occurring, recommended to reduce a_p or rpm and keep feed per tooth.
3. a_p should be reduced when using on low rigidity machine.
4. Use air blow.
5. In case of slotting, apply 50% or less feed (V_f) from standard cutting condition table.

EXTREME SAP
EXSAP/MSX Type
Recommended cutting conditions
EXSAP-17 Type
Modular head type / Face milling

Material	Grade	Tool dia.(mm)									
		32/33/35					40				
		3N					4N				
		ℓ (mm)	a_p (mm)	a_e (mm)	n (min ⁻¹)	V_f (mm/min)	ℓ (mm)	a_p (mm)	a_e (mm)	n (min ⁻¹)	V_f (mm/min)
Carbon steel (S50C, S55C) below 250HB	JC8050	~100	~3.5	~1Dc	1,450	1,310	~100	~3.5	~40	1,190	1,430
		150	~2.5	~25	1,250	940	150	~2.5	~32	1,030	1,030
		210	~1.5	~20	1,060	640	210	~1.5	~24	880	700
Cast steel (GM190, ICD5) below 285HB	JC8050	~100	~3.5	~1Dc	1,450	1,310	~100	~3.5	~40	1,190	1,430
		150	~2.5	~25	1,250	940	150	~2.5	~32	1,030	1,030
		210	~1.5	~20	1,060	640	210	~1.5	~24	880	700
Tool & die steel (SKD61, SKD11) below 255HB	JC8050	~100	~3.5	~1Dc	1,450	1,090	~100	~3.5	~40	1,190	1,190
		150	~2.5	~25	1,250	750	150	~2.5	~32	1,030	820
		210	~1.5	~20	1,060	480	210	~1.5	~24	880	530
Mold steel (HPM7, PX5, P20) 30-36 HRC	JC8118	~100	~3.5	~1Dc	1,250	940	~100	~3.5	~40	1,030	1,030
		150	~2.5	~25	1,160	700	150	~2.5	~32	950	760
		210	~1.5	~20	1,060	480	210	~1.5	~24	880	530
Mold steel (NAK80, HPM1, P21) 38-43HRC	JC8118	~100	~2.5	~1Dc	1,060	800	~100	~2.5	~40	880	880
		150	~2	~25	960	580	150	~2	~32	800	640
		210	~1.5	~20	870	390	210	~1.5	~24	720	430
Hardened die steel (SKD61, DAC, DHA) 42-52HRC	JC8118	~100	~2	~25	870	520	~100	~2	~32	720	580
		150	~1.5	~20	770	350	150	~1.5	~24	640	380
		210	~1	~15	680	200	210	~1	~18	560	220
Grey cast iron (FC250) 160-260HB	JC8118	~100	~5.5	~1Dc	1,930	1,740	~100	~5.5	~40	1,590	1,910
		150	~3.5	~25	1,740	1,310	150	~3.5	~32	1,430	1,430
		210	~1.5	~20	1,540	920	210	~1.5	~24	1,270	1,020
Nodular cast iron (FCD700) 170-300HB	JC8118	~100	~3.5	~1Dc	1,250	940	~100	~3.5	~40	1,030	1,030
		150	~2.5	~25	1,160	700	150	~2.5	~32	950	760
		210	~1.5	~20	1,060	480	210	~1.5	~24	880	530
Austenitic stainless steel (SUS304, 316, 317) 17Cr	JC8050	~100	~3.5	~25	1,060	640	~100	~3.5	~32	880	700
		150	~2.5	~20	960	430	150	~2.5	~24	800	480
		210	~1.5	~15	870	260	210	~1.5	~18	720	290
Ferritic & martensitic stainless steel (SUS403, 420J2, 430) 13Cr	JC8118	~100	~3.5	~1Dc	1,450	1,090	~100	~3.5	~40	1,190	1,190
		150	~2.5	~25	1,250	750	150	~2.5	~32	1,030	820
		210	~1.5	~20	1,060	480	210	~1.5	~24	880	530

Note

1. Please adjust cutting conditions according to machine rigidity or work rigidity.
2. In case of chatter occurring, recommended to reduce a_p or rpm and keep feed per tooth.
3. a_p should be reduced when using on low rigidity machine.
4. Use air blow.
5. In case of slotting, apply 50% or less feed (V_f) from standard cutting condition table.

SHOULDER SIX

EXSIX Type

Double sided insert with 6 cutting edge

SHOULDER SIX

Unique 3D insert

Due to arch-geometry on the peripheral cutting edge, cusp height can be smaller even in case of large ap.

Achieves low cutting force

Achieves high efficient & high precision machining for side walls.



Features

This tool can accommodate an array of applications such as face milling, slotting and plunging. The unique 3D design of the insert has 6 positive axial cutting edges which decreases tool pressure.

Double - sided insert with 6 cutting edge.

The robust insert is 7.5mm in thickness allowing for stable machining and longer tool life.



ISO	P					M					K			H		
	P01	P10	P20	P30	P40	M01	M10	M20	M30	M40	K01	K10	K20	K30	H01	H10
Range	JC8118					JC8118					JC8118			JC8118		
	JC8050			JC8050			JC8050									

SHOULDER SIX

EXSIX Type

■ EXSIX Type -Shoulder Milling

● Double-sided 6 Cutting-edge insert

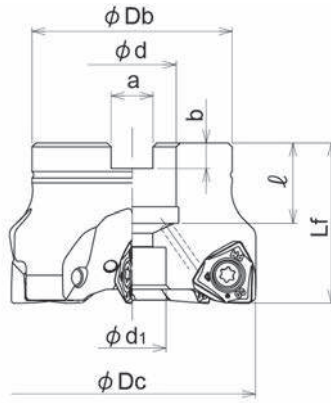

Fig.1
(Through coolant hole)

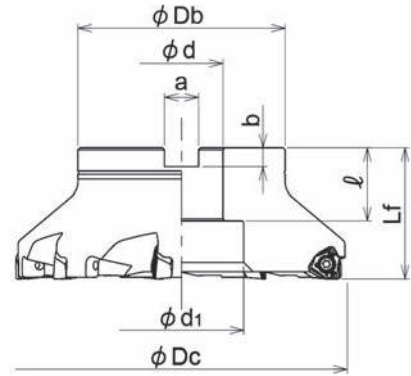

Fig.2
(No coolant hole)

Cat.No.	Stock	No. of inserts	Dimensions (mm)								Arbor set bolt	Weight (kg)	Inserts	Fig.
			ϕDc	L_f	ϕDb	ϕd	ϕd_1	a	b	ℓ				
EXSIX-4050R-22	●	4	50	40	47	22	14	10.4	6.3	20	M10X1.5X25*	0.33	YCMU0907**ZER-PM	1
EXSIX-4052R-22	●		52								M10X1.5X25*	0.35		
EXSIX-5063R-22	●	5	63	50	17	16.4	9	32	35	M10	0.50			
EXSIX-5066R-22	●		66							M10	0.53			
EXSIX-6080R-27	●	6	80	50	56	27	20	12.4	7	22	M12X1.75X30*	0.93		
EXSIX-7100R-32	●	7	100		85	32	26	14.4	8	25	M16X2X30*	1.88		
EXSIX-8125R-40	●	8	125	63	100	40	32	16.4	9	32	M20X2.5X40*	3.62		
EXSIX-9160R-40	●	9	160								60	60		

Screw	Torque(N.m)	Wrench
CSW-513H	5.5	A-20

SHOULDER SIX **EXSIX Type**

■ Insert

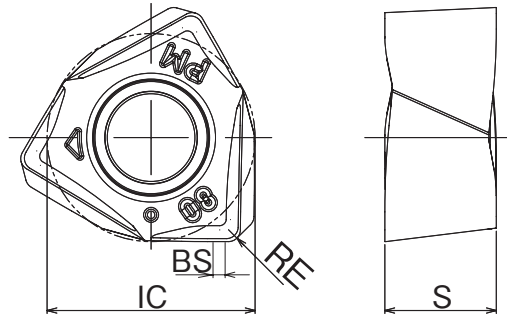

Cat.No.	Tolerance	PVD Coating		Dimensions (mm)			
		JC8050	JC8118	RE	BS	IC	S
YCMU090708ZER-PM	M	●	●	0.8	1.41	14	7.5
YCMU090716ZER-PM		●	●	1.6	0.62		

GRADE MARKING

JC8050

JC8118

SHOULDER SIX
EXSIX Type
Recommended cutting conditions
Shoulder milling

Material	Grade	Tool dia.(mm)									
		50/52					63/66				
		4N					5N				
		r (mm)	ap (mm)	ap×ae (mm ²)	n (min ⁻¹)	Vf (mm/min)	r (mm)	ap (mm)	ap×ae (mm ²)	n (min ⁻¹)	Vf (mm/min)
Carbon steel (S50C, S55C) below 250HB	JC8050	~100	~9.0	~45	1,270	1,520	~100	~9.0	~45	1,010	1,770
		150	~8.0	~30	1,150	1,150	150	~8.0	~30	910	1,370
		200	~7.0	~20	1,020	820	200	~7.0	~20	810	1,010
Cast steel (GM190, LCD5) below 285HB	JC8050	~100	~9.0	~45	1,150	1,380	~100	~9.0	~45	910	1,590
		150	~8.0	~30	1,020	1,020	150	~8.0	~30	810	1,220
		200	~7.0	~20	890	710	200	~7.0	~20	710	890
Tool & die steel (SKD61, SKD11) below 255HB	JC8050	~100	~9.0	~45	1,270	1,520	~100	~9.0	~45	1,010	1,770
		150	~8.0	~30	1,150	1,150	150	~8.0	~30	910	1,370
		200	~7.0	~20	1,020	820	200	~7.0	~20	810	1,010
Mold steel (HPM7, PX5, P20) 30-36 HRC	JC8118	~100	~9.0	~45	950	1,140	~100	~9.0	~45	760	1,330
		150	~8.0	~30	860	860	150	~8.0	~30	680	1,020
		200	~7.0	~20	760	610	200	~7.0	~20	610	760
Mold steel (NAK80, HPM1, P21) 38-43HRC	JC8118	~100	~9.0	~30	760	760	~100	~9.0	~30	610	760
		150	~8.0	~25	670	540	150	~8.0	~25	530	530
		200	~7.0	~15	570	340	200	~7.0	~15	450	340
Hardened die steel (SKD61, DAC, DHA) 42-52HRC	JC8118	~100	~9.0	~25	640	510	~100	~9.0	~25	510	510
		150	~8.0	~15	570	340	150	~8.0	~15	450	340
		200	~7.0	~8	510	200	200	~7.0	~8	400	200
Grey cast iron (FC250) 160-260HB	JC8118	~100	~9.0	~45	1,590	1,910	~100	~9.0	~45	1,260	2,210
		150	~8.0	~30	1,460	1,460	150	~8.0	~30	1,160	1,740
		200	~7.0	~20	1,340	1,070	200	~7.0	~20	1,060	1,330
Nodular cast iron (FCD700) 170-300HB	JC8118	~100	~9.0	~45	950	950	~100	~9.0	~45	760	1,140
		150	~8.0	~30	830	660	150	~8.0	~30	660	830
		200	~7.0	~20	700	420	200	~7.0	~20	560	560
Austenitic stainless steel (SUS304, 316, 317) 17Cr	JC8050	~100	~9.0	~45	760	610	~100	~9.0	~45	610	610
		150	~8.0	~30	700	420	150	~8.0	~30	560	420
		200	~7.0	~20	640	260	200	~7.0	~20	510	260
Ferritic & martensitic stainless steel (SUS403, 420J2, 430) 13Cr	JC8118	~100	~9.0	~45	1,150	1,150	~100	~9.0	~45	910	1,370
		150	~8.0	~30	1,020	820	150	~8.0	~30	810	1,010
		200	~7.0	~20	890	530	200	~7.0	~20	710	710

Note

1. Please adjust cutting conditions according to machine rigidity or work rigidity.
2. In case of chatter occurring, recommended to reduce ap or rpm and keep feed per tooth.
3. ap should be reduced when using on low rigidity machine.
4. Use air blow.

SHOULDER SIX**EXSIX Type**

■ Recommended cutting conditions

● Shoulder milling

Material	Grade	Tool dia.(mm)									
		80					100				
		6N					7N				
		r (mm)	a _p (mm)	a _p ×a _e (mm ²)	n (min ⁻¹)	V _f (mm/min)	r (mm)	a _p (mm)	a _p ×a _e (mm ²)	n (min ⁻¹)	V _f (mm/min)
Carbon steel (S50C, S55C) below 250HB	JC8050	~100	~9.0	~45	800	1,680	~100	~9.0	~45	640	1,570
		150	~8.0	~30	720	1,300	150	~8.0	~30	570	1,200
		200	~7.0	~20	640	960	200	~7.0	~20	510	890
Cast steel (GM190, ICD5) below 285HB	JC8050	~100	~9.0	~45	720	1,510	~100	~9.0	~45	570	1,400
		150	~8.0	~30	640	1,150	150	~8.0	~30	510	1,070
		200	~7.0	~20	560	840	200	~7.0	~20	450	790
Tool & die steel (SKD61, SKD11) below 255HB	JC8050	~100	~9.0	~45	800	1,680	~100	~9.0	~45	640	1,570
		150	~8.0	~30	720	1,300	150	~8.0	~30	570	1,200
		200	~7.0	~20	640	960	200	~7.0	~20	510	890
Mold steel (HPM7, PX5, P20) 30-36 HRC	JC8118	~100	~9.0	~45	600	1,260	~100	~9.0	~45	480	1,180
		150	~8.0	~30	540	970	150	~8.0	~30	430	900
		200	~7.0	~20	480	720	200	~7.0	~20	380	670
Mold steel (NAK80, HPM1, P21) 38-43HRC	JC8118	~100	~9.0	~30	480	720	~100	~9.0	~30	380	670
		150	~8.0	~25	420	500	150	~8.0	~25	330	460
		200	~7.0	~15	360	320	200	~7.0	~15	290	300
Hardened die steel (SKD61, DAC, DHA) 42-52HRC	JC8118	~100	~9.0	~25	400	480	~100	~9.0	~25	320	450
		150	~8.0	~15	360	320	150	~8.0	~15	290	300
		200	~7.0	~8	320	190	200	~7.0	~8	250	180
Grey cast iron (FC250) 160-260HB	JC8118	~100	~9.0	~45	990	2,080	~100	~9.0	~45	800	1,960
		150	~8.0	~30	920	1,660	150	~8.0	~30	730	1,530
		200	~7.0	~20	840	1,260	200	~7.0	~20	670	1,170
Nodular cast iron (FCD700) 170-300HB	JC8118	~100	~9.0	~45	600	1,080	~100	~9.0	~45	480	1,010
		150	~8.0	~30	520	780	150	~8.0	~30	410	720
		200	~7.0	~20	440	530	200	~7.0	~20	350	490
Austenitic stainless steel (SUS304, 316, 317) 17Cr	JC8050	~100	~9.0	~45	480	580	~100	~9.0	~45	380	530
		150	~8.0	~30	440	400	150	~8.0	~30	350	370
		200	~7.0	~20	400	240	200	~7.0	~20	320	220
Ferritic & martensitic stainless steel (SUS403, 420J2, 430) 13Cr	JC8118	~100	~9.0	~45	720	1,300	~100	~9.0	~45	570	1,200
		150	~8.0	~30	640	960	150	~8.0	~30	510	890
		200	~7.0	~20	560	670	200	~7.0	~20	450	630

Note

1. Please adjust cutting conditions according to machine rigidity or work rigidity.
2. In case of chatter occurring, recommended to reduce a_p or rpm and keep feed per tooth.
3. a_p should be reduced when using on low rigidity machine.
4. Use air blow.

SHOULDER SIX

EXSIX Type

■ Recommended cutting conditions

● Shoulder milling

Material	Grade	Tool dia.(mm)									
		125					160				
		8N					9N				
		r (mm)	ap (mm)	ap×ae (mm ²)	n (min ⁻¹)	Vf (mm/min)	r (mm)	ap (mm)	ap×ae (mm ²)	n (min ⁻¹)	Vf (mm/min)
Carbon steel (S50C, S55C) below 250HB	JC8050	~100	~9.0	~45	510	1,430	~100	~9.0	~45	400	1,260
		150	~8.0	~30	460	1,100	150	~8.0	~30	360	970
		200	~7.0	~20	410	820	200	~7.0	~20	320	720
Cast steel (GM190, ICD5) below 285HB	JC8050	~100	~9.0	~45	460	1,290	~100	~9.0	~45	360	1,130
		150	~8.0	~30	410	980	150	~8.0	~30	320	860
		200	~7.0	~20	360	720	200	~7.0	~20	280	630
Tool & die steel (SKD61, SKD11) below 255HB	JC8050	~100	~9.0	~45	510	1,430	~100	~9.0	~45	400	1,260
		150	~8.0	~30	460	1,100	150	~8.0	~30	360	970
		200	~7.0	~20	410	820	200	~7.0	~20	320	720
Mold steel (HPM7, PX5, P20) 30-36 HRC	JC8118	~100	~9.0	~45	380	1,060	~100	~9.0	~45	300	950
		150	~8.0	~30	340	820	150	~8.0	~30	270	730
		200	~7.0	~20	310	620	200	~7.0	~20	240	540
Mold steel (NAK80, HPM1, P21) 38-43HRC	JC8118	~100	~9.0	~30	310	620	~100	~9.0	~30	240	540
		150	~8.0	~25	270	430	150	~8.0	~25	210	380
		200	~7.0	~15	230	280	200	~7.0	~15	180	240
Hardened die steel (SKD61, DAC, DHA) 42-52HRC	JC8118	~100	~9.0	~25	250	400	~100	~9.0	~25	200	360
		150	~8.0	~15	230	280	150	~8.0	~15	180	240
		200	~7.0	~8	200	160	200	~7.0	~8	160	140
Grey cast iron (FC250) 160-260HB	JC8118	~100	~9.0	~45	640	1,790	~100	~9.0	~45	500	1,580
		150	~8.0	~30	590	1,420	150	~8.0	~30	460	1,240
		200	~7.0	~20	530	1,060	200	~7.0	~20	420	950
Nodular cast iron (FCD700) 170-300HB	JC8118	~100	~9.0	~45	380	910	~100	~9.0	~45	300	810
		150	~8.0	~30	330	660	150	~8.0	~30	260	590
		200	~7.0	~20	280	450	200	~7.0	~20	220	400
Austenitic stainless steel (SUS304, 316, 317) 17Cr	JC8050	~100	~9.0	~45	310	500	~100	~9.0	~45	240	430
		150	~8.0	~30	280	340	150	~8.0	~30	220	300
		200	~7.0	~20	250	200	200	~7.0	~20	200	180
Ferritic & martensitic stainless steel (SUS403, 420J2, 430) 13Cr	JC8118	~100	~9.0	~45	460	1,100	~100	~9.0	~45	360	970
		150	~8.0	~30	410	820	150	~8.0	~30	320	720
		200	~7.0	~20	360	580	200	~7.0	~20	280	500

Note

1. Please adjust cutting conditions according to machine rigidity or work rigidity.
2. In case of chatter occurring, recommended to reduce ap or rpm and keep feed per tooth.
3. ap should be reduced when using on low rigidity machine.
4. Use air blow.

SHOULDER SIX**EXSIX Type**

■ Recommended cutting conditions

● Face milling

Material	Grade	Tool dia.(mm)									
		50/52					63/66				
		4N					5N				
		r (mm)	a _p (mm)	a _e (mm)	n (min ⁻¹)	V _f (mm/min)	r (mm)	a _p (mm)	a _e (mm)	n (min ⁻¹)	V _f (mm/min)
Carbon steel (S50C, S55C) below 250HB	JC8050	~150	~4.0	~1.0Dc	950	1,140	~150	~4.0	~1.0Dc	760	1,330
		200	~3.0	~40	830	830	200	~3.0	~55	660	990
		300	~2.0	~30	700	560	300	~2.0	~40	560	700
Cast steel (GM190, ICD5) below 285HB	JC8050	~150	~4.0	~1.0Dc	950	1,140	~150	~4.0	~1.0Dc	760	1,330
		200	~3.0	~40	830	830	200	~3.0	~55	660	990
		300	~2.0	~30	700	560	300	~2.0	~40	560	700
Tool & die steel (SKD61, SKD11) below 255HB	JC8050	~150	~4.0	~1.0Dc	950	950	~150	~4.0	~1.0Dc	760	1,140
		200	~3.0	~40	830	660	200	~3.0	~55	660	830
		300	~2.0	~30	700	420	300	~2.0	~40	560	560
Mold steel (HPM7, PX5, P20) 30-36 HRC	JC8118	~150	~4.0	~1.0Dc	830	830	~150	~4.0	~1.0Dc	660	990
		200	~3.0	~40	760	610	200	~3.0	~55	610	760
		300	~2.0	~30	700	420	300	~2.0	~40	560	560
Mold steel (NAK80, HPM1, P21) 38-43HRC	JC8118	~150	~3.0	~1.0Dc	700	700	~150	~3.0	~1.0Dc	560	700
		200	~2.5	~40	640	510	200	~2.5	~55	510	510
		300	~1.5	~30	570	340	300	~1.5	~40	450	340
Hardened die steel (SKD61, DAC, DHA) 42-52HRC	JC8118	~150	~2.5	~40	570	460	~150	~2.5	~55	450	450
		200	~2.0	~30	510	310	200	~2.0	~40	400	300
		300	~1.5	~20	450	180	300	~1.5	~32	350	180
Grey cast iron (FC250) 160-260HB	JC8118	~150	~6.0	~1.0Dc	1,150	1,380	~150	~6.0	~1.0Dc	910	1,590
		200	~4.0	~40	950	950	200	~4.0	~55	760	1,140
		300	~2.0	~30	830	660	300	~2.0	~40	660	830
Nodular cast iron (FCD700) 170-300HB	JC8118	~150	~4.0	~1.0Dc	830	830	~150	~4.0	~1.0Dc	660	990
		200	~3.0	~40	760	610	200	~3.0	~55	610	760
		300	~2.0	~30	700	420	300	~2.0	~40	560	560
Austenitic stainless steel (SUS304, 316, 317) 17Cr	JC8050	~150	~4.0	~40	700	560	~150	~4.0	~55	560	560
		200	~3.0	~30	640	380	200	~3.0	~40	510	380
		300	~2.0	~20	570	230	300	~2.0	~32	450	230
Ferritic & martensitic stainless steel (SUS403, 420J2, 430) 13Cr	JC8118	~150	~4.0	~1.0Dc	950	950	~150	~4.0	~1.0Dc	760	1,140
		200	~3.0	~40	830	660	200	~3.0	~55	660	830
		300	~2.0	~30	700	420	300	~2.0	~40	560	560

Note

1. Please adjust cutting conditions according to machine rigidity or work rigidity.
2. In case of chatter occurring, recommended to reduce a_p or rpm and keep feed per tooth.
3. a_p should be reduced when using on low rigidity machine.
4. Use air blow.
5. In case of slot milling, apply 50% or less feed (V_f) from standard cutting condition table.
6. Ramping and helical interpolation are not recommended.

SHOULDER SIX
EXSIX Type
■ Recommended cutting conditions
● Face milling

Material	Grade	Tool dia.(mm)									
		80					100				
		6N					7N				
		r (mm)	ap (mm)	ae (mm)	n (min ⁻¹)	Vf (mm/min)	r (mm)	ap (mm)	ae (mm)	n (min ⁻¹)	Vf (mm/min)
Carbon steel (S50C, S55C) below 250HB	JC8050	~150	~4.0	~80	600	1,260	~150	~4.0	~100	480	1,010
		200	~3.0	~65	520	940	200	~3.0	~80	410	720
		300	~2.0	~50	440	660	300	~2.0	~60	350	490
Cast steel (GM190, ICD5) below 285HB	JC8050	~150	~4.0	~80	600	1,260	~150	~4.0	~100	480	1,010
		200	~3.0	~65	520	940	200	~3.0	~80	410	720
		300	~2.0	~50	440	660	300	~2.0	~60	350	490
Tool & die steel (SKD61, SKD11) below 255HB	JC8050	~150	~4.0	~80	600	1,080	~150	~4.0	~100	480	840
		200	~3.0	~65	520	780	200	~3.0	~80	410	570
		300	~2.0	~50	440	530	300	~2.0	~60	350	370
Mold steel (HPM7, PX5, P20) 30-36 HRC	JC8118	~150	~4.0	~80	520	940	~150	~4.0	~100	410	720
		200	~3.0	~65	480	720	200	~3.0	~80	380	530
		300	~2.0	~50	440	530	300	~2.0	~60	350	370
Mold steel (NAK80, HPM1, P21) 38-43HRC	JC8118	~150	~3.0	~80	440	660	~150	~3.0	~100	350	490
		200	~2.5	~65	400	480	200	~2.5	~80	320	340
		300	~1.5	~50	360	320	300	~1.5	~60	290	200
Hardened die steel (SKD61, DAC, DHA) 42-52HRC	JC8118	~150	~2.5	~65	360	430	~150	~2.5	~80	290	300
		200	~2.0	~50	320	290	200	~2.0	~60	250	180
		300	~1.5	~35	280	170	300	~1.5	~40	220	150
Grey cast iron (FC250) 160-260HB	JC8118	~150	~6.0	~80	720	1,510	~150	~6.0	~100	570	1,200
		200	~4.0	~65	600	1,080	200	~4.0	~80	480	840
		300	~2.0	~50	520	780	300	~2.0	~60	410	570
Nodular cast iron (FCD700) 170-300HB	JC8118	~150	~4.0	~80	520	940	~150	~4.0	~100	410	720
		200	~3.0	~65	480	720	200	~3.0	~80	380	530
		300	~2.0	~50	440	530	300	~2.0	~60	350	370
Austenitic stainless steel (SUS304, 316, 317) 17Cr	JC8050	~150	~4.0	~65	440	530	~150	~4.0	~80	350	370
		200	~3.0	~50	400	360	200	~3.0	~60	320	220
		300	~2.0	~35	360	220	300	~2.0	~40	290	200
Ferritic & martensitic stainless steel (SUS403, 420J2, 430) 13Cr	JC8118	~150	~4.0	~80	600	1,080	~150	~4.0	~100	480	840
		200	~3.0	~65	520	780	200	~3.0	~80	410	570
		300	~2.0	~50	440	530	300	~2.0	~60	350	370

Note

1. Please adjust cutting conditions according to machine rigidity or work rigidity.
2. In case of chatter occurring, recommended to reduce ap or rpm and keep feed per tooth.
3. ap should be reduced when using on low rigidity machine.
4. Use air blow.
5. In case of slot milling, apply 50% or less feed (Vf) from standard cutting condition table.
6. Ramping and helical interpolation are not recommended.

SHOULDER SIX**EXSIX Type**

■ Recommended cutting conditions

● Face milling

Material	Grade	Tool dia.(mm)									
		125					160				
		8N					9N				
		r (mm)	a _p (mm)	a _e (mm)	n (min ⁻¹)	V _f (mm/min)	r (mm)	a _p (mm)	a _e (mm)	n (min ⁻¹)	V _f (mm/min)
Carbon steel (S50C, S55C) below 250HB	JC8050	~150	~4.0	~125	380	910	~150	~4.0	~160	300	810
		200	~3.0	~100	330	660	200	~3.0	~130	260	590
		300	~2.0	~75	280	450	300	~2.0	~95	220	400
Cast steel (GM190, ICD5) below 285HB	JC8050	~150	~4.0	~125	380	910	~150	~4.0	~160	300	810
		200	~3.0	~100	330	660	200	~3.0	~130	260	590
		300	~2.0	~75	280	450	300	~2.0	~95	220	400
Tool & die steel (SKD61, SKD11) below 255HB	JC8050	~150	~4.0	~125	380	760	~150	~4.0	~160	300	680
		200	~3.0	~100	330	530	200	~3.0	~130	260	470
		300	~2.0	~75	280	340	300	~2.0	~95	220	300
Mold steel (HPM7, PX5, P20) 30-36 HRC	JC8118	~150	~4.0	~125	330	660	~150	~4.0	~160	260	590
		200	~3.0	~100	310	500	200	~3.0	~130	240	430
		300	~2.0	~75	280	340	300	~2.0	~95	220	300
Mold steel (NAK80, HPM1, P21) 38-43HRC	JC8118	~150	~3.0	~125	280	450	~150	~3.0	~160	220	400
		200	~2.5	~100	250	300	200	~2.5	~130	200	270
		300	~1.5	~75	230	180	300	~1.5	~95	180	160
Hardened die steel (SKD61, DAC, DHA) 42-52HRC	JC8118	~150	~2.5	~100	230	280	~150	~2.5	~130	180	240
		200	~2.0	~75	200	160	200	~2.0	~95	160	140
		300	~1.5	~50	180	140	300	~1.5	~60	140	130
Grey cast iron (FC250) 160-260HB	JC8118	~150	~6.0	~125	460	1,100	~150	~6.0	~160	360	970
		200	~4.0	~100	380	760	200	~4.0	~130	300	680
		300	~2.0	~75	330	530	300	~2.0	~95	260	470
Nodular cast iron (FCD700) 170-300HB	JC8118	~150	~4.0	~125	330	660	~150	~4.0	~160	260	590
		200	~3.0	~100	310	500	200	~3.0	~130	240	430
		300	~2.0	~75	280	340	300	~2.0	~95	220	300
Austenitic stainless steel (SUS304, 316, 317) 17Cr	JC8050	~150	~4.0	~100	280	340	~150	~4.0	~130	220	300
		200	~3.0	~75	250	200	200	~3.0	~95	200	180
		300	~2.0	~50	230	180	300	~2.0	~60	180	160
Ferritic & martensitic stainless steel (SUS403, 420J2, 430) 13Cr	JC8118	~150	~4.0	~125	380	760	~150	~4.0	~160	300	680
		200	~3.0	~100	330	530	200	~3.0	~130	260	470
		300	~2.0	~75	280	340	300	~2.0	~95	220	300

Note

1. Please adjust cutting conditions according to machine rigidity or work rigidity.
2. In case of chatter occurring, recommended to reduce a_p or rpm and keep feed per tooth.
3. a_p should be reduced when using on low rigidity machine.
4. Use air blow.
5. In case of slot milling, apply 50% or less feed (V_f) from standard cutting condition table.
6. Ramping and helical interpolation are not recommended.

SHOULDER SIX**EXSIX Type**

■ Recommended cutting conditions

● Plunge milling

Material	Grade	Vc(m/min)	fz(mm/t)	ae(mm)	Pf(mm)
Carbon steel (S50C, S55C) below 250HB	JC8050	180	0.25	~5	~0.5Dc
Cast steel (GM190, ICD5) below 285HB	JC8050	160	0.25	~5	~0.5Dc
Tool & die steel (SKD61, SKD11) below 255HB	JC8050	180	0.2	~5	~0.5Dc
Mold steel (HPM7, PX5, P20) 30-36 HRC	JC8118	130	0.2	~5	~0.5Dc
Mold steel (NAK80, HPM1, P21) 38-43HRC	JC8118	100	0.15	~5	~0.5Dc
Hardened die steel (SKD61, DAC, DHA) 42-52HRC	JC8118	90	0.1	~5	~0.5Dc
Grey cast iron (FC250) 160-260HB	JC8118	200	0.3	~5	~0.5Dc
Nodular cast iron (FCD700) 170-300HB	JC8118	130	0.2	~5	~0.5Dc
Austenitic stainless steel (SUS304, 316, 317) 17Cr	JC8050	110	0.15	~5	~0.5Dc
Ferritic & martensitic stainless steel (SUS403, 420J2, 430) 13Cr	JC8118	160	0.2	~5	~0.5Dc

Note

1. Please adjust cutting conditions according to machine rigidity or work rigidity.
2. In case of chatter occurring, recommended to reduce ap or rpm and keep feed per tooth.
3. ap should be reduced when using on low rigidity machine.
4. Use air blow..

SIC-EVO

SSV Type

進化した。SIC-EVO



Feature 1

Max. depth of cut (a_p) = 15mm is possible.

Usable for a wide range of applications such as face milling, slotting, pocket milling & side milling.

Arc geometry on peripheral cutting edge

Cusp height can be smaller even in case of large a_p . achieves high efficient & high precision machining for vertical walls.

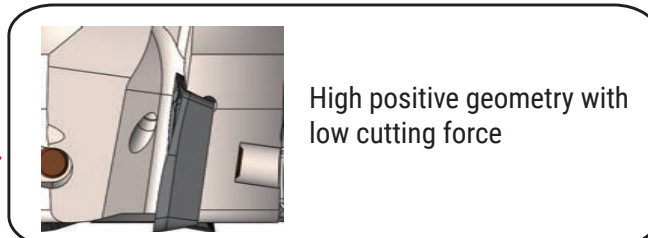

Capable of ramping & helical interpolation

Feature 2

Available corner radius: R0.4, R0.8, R1.6, R2.0 & R3.0

■ Insert grades

ISO	P					M					K				H		
	P01	P10	P20	P30	P40	M01	M10	M20	M30	M40	K01	K10	K20	K30	H01	H10	H20
Range			JC8118					JC8118					JC8118				JC8118
			JC8050					JC8050									

SIC-EVO

SSV Type

■ **Facemill Type**

Through coolant hole

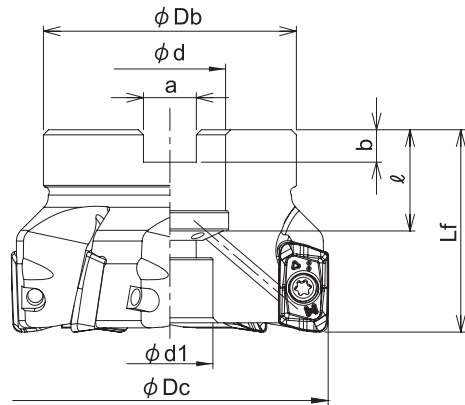

Cat.No.	Stock	No. of inserts	Dimensions (mm)								Arbor set bolt	Weight (kg)	Insert
			ϕDc	Lf	ϕDb	ϕd	$\phi d1$	a	b	ℓ			
SSV-4040R-16	●	4	40	40	35	16	14	8.4	5.6	18	M8	0.20	ZOMT1605**ZER-PM
SSV-5050R-22	●	5	50		47	22	17	10.4	6.3	20	M10	0.33	
SSV-6063R-22	●	6	63		50	20	12.4	7	22	M12X1.75X30*	0.75		
SSV-6063R-27	●			60	27							20	
SSV-7080R-27	●	7	80	50	60	27	20	12.4	7	22	M12X1.75X30	1.08	
SSV-8100R-32	●	8	100		85	32	26	14.4	8	25	M16X2X30*	1.95	
SSV-8125R-40	●			125	63	100	40	32	16.4	9	32	M20X2.5X40*	

Screw	Torque(N.m)	Wrench
DSW-4075H	3.6	A-15T

SIC-EVO **SSV Type**

■ **Modular Head Type**

Through coolant hole

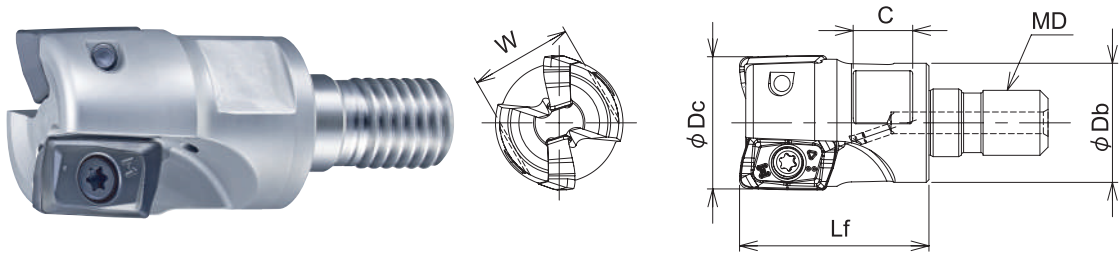

Cat.No.	Stock	No. of inserts	Dimensions (mm)						Insert
			φDc	Lf	φDb	MD	C	W	
SSV-2025-M12	●	2	25	35	22	M12	11	19	ZOMT1605**ZER-PM
SSV-2028-M12	●		28						
SSV-3030-M16	●	3	30	43	29	M16	12	22	
SSV-3032-M16	●		32						
SSV-3035-M16	●		35						
SSV-4040-M16	●	4	40						

Screw	Torque(N.m)	Wrench
DSW-4075H	3.6	A-15T

SIC-EVO

SSV Type

■ **Endmill Shank Type**

Through coolant hole

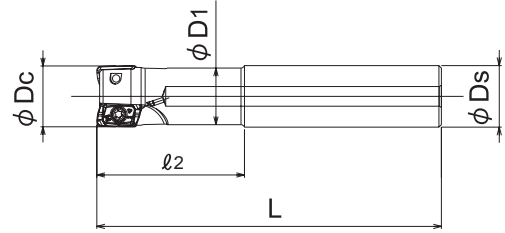
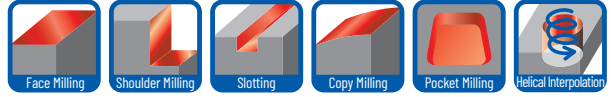

Cat.No.	Stock	No. of inserts	Dimensions (mm)					Parts		Insert
			φDc	ℓ2	L	φD1	φDs	Wrench		
SSV-2025-60-S25+A	●	2	25	60	140	23	25	A-15	ZOMT1605**ZER-PM	
SSV-2025-100-S25+A	●			100	180					
SSV-3032-70-S32+A	●	3	32	70	150	29	32			
SSV-3032-120-S32+A	●	3		120	200					
SSV-4040-50-S32+A	●	4	40	50	150	37				

Screw	Torque(N.m)	Wrench
DSW-4075H	3.6	A-15

SIC-EVO **SSV Type**

■ **Insert**

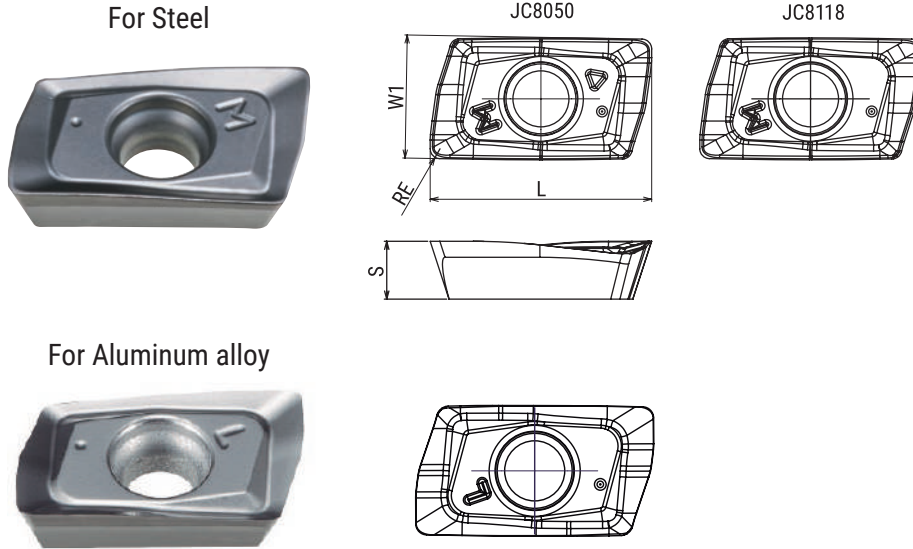

Cat.No.	Tolerance	PVD Coating		Uncoated	Dimensions (mm)			
		JC8050	JC8118	FC18	RE	L	W1	S
ZOMT160504ZER-PM	M	●	●		0.4	18	10	4.7
ZOMT160508ZER-PM		●	●		0.8			
ZOMT160516ZER-PM		●	●		1.6			
ZOMT160520ZER-PM		●	●		2			
ZOMT160530ZER-PM		●	●		3			
ZOET160508ZFR-NL	E			●	0.8			

GRADE MARKINGS

JC8050

JC8118

ZOMT160504ZER-PM
ZOMT160508ZER-PM
ZOMT160516ZER-PM
ZOMT160520ZER-PM
ZOMT160530ZER-PM

SIC-EVO

SSV Type

Recommended Data for Profile Milling

Ramping

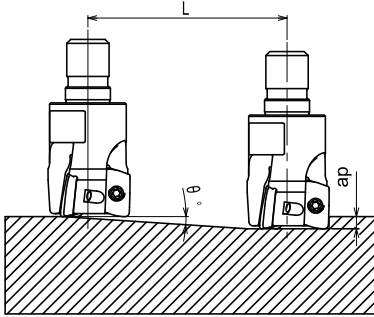

Helical interpolation

Blind hole

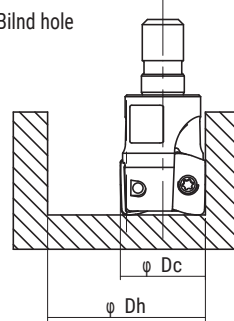

Through hole

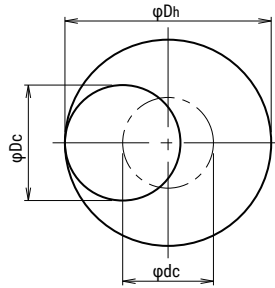
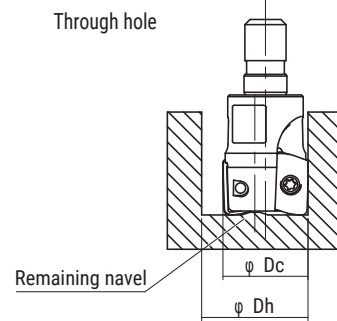

- In case of ramping and helical interpolation, apply 80% or less feed (Vf) from standard cutting condition table
- In case of drilling, apply 50% or less feed (Vf) from standard cutting condition table
- In case of helical interpolation, recommend wet cutting by coolant through the tool
- Long chips may come out in case of drilling, confirm safe operating conditions

- Calculation of tool pass dia.

$$\phi_{dc} = \phi_{Dh} - \phi_{Dc}$$

Tool pass dia. Bore dia. Tool Dia.

- Depth of cut per one circuit should not exceed max. depth of cut Ap
- Down cutting is recommended, tool pass rotation should be counterclockwise

ZOMT160504ZER-PM

Cat.No.	Tool dia. (mm)	Effective cutting dia. (mm)	Max.depth of cut : ap (mm)	Ramping		Helical interpolation			Max. drilling depth: Z
				Max. ramping angle θ	Max. depth of cut (ap) Total cutting length L(mm)	Through hole Min. Bore dia. (mm)	Blind hole Min. Bore dia. (mm)	Blind hole Max. Bore dia. (mm)	
SSV-2025-**	25	23.9	1.5	6.2	13.8	31	48	48.8	1.6
SSV-2028-M12	28	26.9	1.5	5.3	16.2	37	54	54.8	1.6
SSV-3030-**	30	28.9	1.5	4.8	17.9	41	58	58.8	1.6
SSV-3032-**	32	30.9	1.5	4.4	19.5	45	62	62.8	1.6
SSV-3035-M16	35	33.9	1.5	4.3	19.9	51	68	68.8	1.6
SSV-4040-**	40	38.9	1.5	3.6	23.8	61	78	78.8	1.6
SSV-5050R-**	50	48.9	1.5	2.4	35.8	81	98	98.8	1.4
SSV-6063R-**	63	61.9	1.5	1.7	50.5	107	124	124.8	1.4
SSV-7080R-**	80	78.9	1.5	1.2	71.6	141	158	158.8	1.4
SSV-8100R-**	100	98.9	1.5	0.9	95.5	181	198	198.8	1.4
SSV-8125R-**	125	123.9	1.5	0.65	132.2	231	248	248.8	1.4

ZOMT160508ZER-PM

Cat.No.	Tool dia. (mm)	Effective cutting dia. (mm)	Max.depth of cut : ap (mm)	Ramping		Helical interpolation			Max. drilling depth: Z
				Max. ramping angle θ	Max. depth of cut (ap) Total cutting length L(mm)	Through hole Min. Bore dia. (mm)	Blind hole Min. Bore dia. (mm)	Blind hole Max. Bore dia. (mm)	
SSV-2025-**	25	23.1	1.5	6.4	13.4	31	47.2	48	1.6
SSV-2028-M12	28	26.1	1.5	5.4	15.9	37	53.2	54	1.6
SSV-3030-**	30	28.1	1.5	4.8	17.9	41	57.2	58	1.6
SSV-3032-**	32	30.1	1.5	4.4	19.5	45	61.2	62	1.6
SSV-3035-M16	35	33.1	1.5	4.3	19.9	51	67.2	68	1.6
SSV-4040-**	40	38.1	1.5	3.6	23.8	61	77.2	78	1.6
SSV-5050R-**	50	48.1	1.5	2.4	35.8	81	97.2	98	1.4
SSV-6063R-**	63	61.1	1.5	1.7	50.5	107	123.2	124	1.4
SSV-7080R-**	80	78.1	1.5	1.2	71.6	141	157.2	158	1.4
SSV-8100R-**	100	98.1	1.5	0.9	95.5	181	197.2	198	1.4
SSV-8125R-**	125	123.1	1.5	0.65	132.2	231	247.2	248	1.4

SIC-EVO**SSV Type****ZOMT160516ZER-PM**

Cat.No.	Tool dia. (mm)	Effective cutting dia. (mm)	Max.depth of cut: ap (mm)	Ramping		Helical interpolation			Max. drilling depth: Z
				Max. ramping angle θ	Max. depth of cut (ap) Total cutting length L(mm)	Through hole Min. Bore dia. (mm)	Blind hole Min. Bore dia. (mm)	Blind hole Max. Bore dia. (mm)	
SSV-2025-**	25	21.5	1.5	6.7	12.8	31	45.8	46.4	1.5
SSV-2028-M12	28	24.5	1.5	5.6	15.3	37	51.8	52.4	1.5
SSV-3030-**	30	26.5	1.5	5	17.1	41	55.8	56.4	1.5
SSV-3032-**	32	28.5	1.5	4.7	18.2	45	59.8	60.4	1.5
SSV-3035-M16	35	31.5	1.5	4.6	18.6	51	65.8	66.4	1.5
SSV-4040-**	40	36.5	1.5	3.8	22.6	61	75.8	76.4	1.5
SSV-5050R-**	50	46.5	1.5	2.5	34.4	81	95.8	96.4	1.4
SSV-6063R-**	63	59.5	1.5	1.8	47.7	107	121.8	122.4	1.4
SSV-7080R-**	80	76.5	1.5	1.2	71.6	141	155.8	156.4	1.4
SSV-8100R-**	100	96.5	1.5	0.9	95.5	181	195.8	196.4	1.4
SSV-8125R-**	125	121.5	1.5	0.65	132.2	231	245.8	246.4	1.4

ZOMT160520ZER-PM

Cat.No.	Tool dia. (mm)	Effective cutting dia. (mm)	Max.depth of cut: ap (mm)	Ramping		Helical interpolation			Max. drilling depth: Z
				Max. ramping angle θ	Max. depth of cut (ap) Total cutting length L(mm)	Through hole Min. Bore dia. (mm)	Blind hole Min. Bore dia. (mm)	Blind hole Max. Bore dia. (mm)	
SSV-2025-**	25	20.7	1.5	6.9	12.4	31	45	45.6	1.5
SSV-2028-M12	28	23.7	1.5	5.7	15.0	37	51	51.6	1.5
SSV-3030-**	30	25.7	1.5	5	17.1	41	55	55.6	1.5
SSV-3032-**	32	27.7	1.5	4.7	18.2	45	59	59.6	1.5
SSV-3035-M16	35	30.7	1.5	4.6	18.6	51	65	65.6	1.5
SSV-4040-**	40	35.7	1.5	3.8	22.6	61	75	75.6	1.5
SSV-5050R-**	50	45.7	1.5	2.5	34.4	81	95	95.6	1.4
SSV-6063R-**	63	58.7	1.5	1.8	47.7	107	121	121.6	1.4
SSV-7080R-**	80	75.7	1.5	1.2	71.6	141	155	155.6	1.4
SSV-8100R-**	100	95.7	1.5	0.9	95.5	181	195	195.6	1.4
SSV-8125R-**	125	120.7	1.5	0.65	132.2	231	245	245.6	1.4

ZOMT160530ZER-PM

Cat.No.	Tool dia. (mm)	Effective cutting dia. (mm)	Max.depth of cut: ap (mm)	Ramping		Helical interpolation			Max. drilling depth: Z
				Max. ramping angle θ	Max. depth of cut (ap) Total cutting length L(mm)	Through hole Min. Bore dia. (mm)	Blind hole Min. Bore dia. (mm)	Blind hole Max. Bore dia. (mm)	
SSV-2025-**	25	18.7	1.5	7.2	11.9	31	43	43.6	1.5
SSV-2028-M12	28	21.7	1.5	6	14.3	37	49	49.6	1.5
SSV-3030-**	30	23.7	1.5	5.3	16.2	41	53	53.6	1.5
SSV-3032-**	32	25.7	1.5	4.8	17.9	45	57	57.6	1.5
SSV-3035-M16	35	28.7	1.5	4.7	18.2	51	63	63.6	1.5
SSV-4040-**	40	33.7	1.5	3.9	22.0	61	73	73.6	1.5
SSV-5050R-**	50	43.7	1.5	2.5	34.4	81	93	93.6	1.4
SSV-6063R-**	63	56.7	1.5	1.8	47.7	107	119	119.6	1.4
SSV-7080R-**	80	73.7	1.5	1.3	66.1	141	153	153.6	1.4
SSV-8100R-**	100	93.7	1.5	0.95	90.5	181	193	193.6	1.4
SSV-8125R-**	125	118.7	1.5	0.65	132.2	231	243	243.6	1.4

SIC-EVO**SSV Type**

■ Recommended cutting conditions

● Facemill type - Shoulder milling

Material	Grade	Tool dia.(mm)									
		40					50				
		4N					5N				
		ℓ (mm)	a_p (mm)	$a_p \times a_e$ (mm ²)	n (min ⁻¹)	V_f (mm/min)	ℓ (mm)	a_p (mm)	$a_p \times a_e$ (mm ²)	n (min ⁻¹)	V_f (mm/min)
Carbon steel (S50C, S55C) below 250HB	JC8050	~100	~15.0	~30	1,590	1,910	~100	~15.0	~40	1,270	1,910
		150	~12.0	~20	1,430	1,430	150	~12.0	~25	1,150	1,440
		200	~10.0	~12	1,270	1,020	200	~10.0	~15	1,020	1,020
Cast steel (GM190, ICD5) below 285HB	JC8050	~100	~15.0	~30	1,430	1,720	~100	~15.0	~40	1,150	1,730
		150	~12.0	~20	1,270	1,270	150	~12.0	~25	1,020	1,280
		200	~10.0	~12	1,110	890	200	~10.0	~15	890	890
Tool & die steel (SKD61, SKD11) below 255HB	JC8050	~100	~15.0	~30	1,590	1,910	~100	~15.0	~40	1,270	1,910
		150	~12.0	~20	1,430	1,430	150	~12.0	~25	1,150	1,440
		200	~10.0	~12	1,270	1,020	200	~10.0	~15	1,020	1,020
Mold steel (HPM7, PX5, P20) 30-36 HRC	JC8118	~100	~15.0	~30	1,190	1,430	~100	~15.0	~40	950	1,430
		150	~12.0	~20	1,070	1,070	150	~12.0	~25	860	1,080
		200	~10.0	~12	950	760	200	~10.0	~15	760	760
Mold steel (NAK80, HPM1, P21) 38-43HRC	JC8118	~100	~15.0	~20	950	950	~100	~15.0	~30	760	950
		150	~12.0	~15	840	670	150	~12.0	~20	670	670
		200	~10.0	~8	720	430	200	~10.0	~12	570	430
Hardened die steel (SKD61, DAC, DHA) 42-52HRC	JC8118	~100	~12.0	~12	800	640	~100	~15.0	~18	640	640
		150	~10.0	~8	720	430	150	~12.0	~12	570	430
		200	~8.0	~3	640	260	200	~10.0	~5	510	260
Grey cast iron (FC250) 160-260HB	JC8118	~100	~15.0	~30	1,990	2,390	~100	~15.0	~40	1,590	2,390
		150	~12.0	~20	1,830	1,830	150	~12.0	~25	1,460	1,830
		200	~10.0	~12	1,670	1,340	200	~10.0	~15	1,340	1,340
Nodular cast iron (FCD700) 170-300HB	JC8118	~100	~15.0	~30	1,190	1,190	~100	~15.0	~40	950	1,190
		150	~12.0	~20	1,030	820	150	~12.0	~25	830	830
		200	~10.0	~12	880	530	200	~10.0	~15	700	530
Austenitic stainless steel (SUS304, 316, 317) 17Cr	JC8050	~100	~15.0	~30	950	760	~100	~15.0	~40	760	760
		150	~12.0	~20	880	530	150	~12.0	~25	700	530
		200	~10.0	~12	800	320	200	~10.0	~15	640	320
Ferritic & martensitic stainless steel (SUS403, 420J2, 430) 13Cr	JC8118	~100	~15.0	~30	1,430	1,430	~100	~15.0	~40	1,150	1,440
		150	~12.0	~20	1,270	1,020	150	~12.0	~25	1,020	1,020
		200	~10.0	~12	1,110	670	200	~10.0	~15	890	670

Note

1. Please adjust cutting conditions according to machine rigidity or work rigidity.
2. In case of chatter occurring, recommended to reduce a_p or rpm and keep feed per tooth.
3. a_p should be reduced when using on low rigidity machine.
4. Use air blow.

SIC-EVO**SSV Type**

- Recommended cutting conditions
- Facemill type - Shoulder milling

Material	Grade	Tool dia.(mm)									
		63					80				
		6N					7N				
		ℓ (mm)	a_p (mm)	$a_p \times a_e$ (mm ²)	n (min ⁻¹)	V_f (mm/min)	ℓ (mm)	a_p (mm)	$a_p \times a_e$ (mm ²)	n (min ⁻¹)	V_f (mm/min)
Carbon steel (S50C, S55C) below 250HB	JC8050	~100	~15.0	~45	1,010	2,120	~100	~15.0	~45	800	1,960
		150	~12.0	~30	910	1,640	150	~12.0	~30	720	1,510
		200	~10.0	~20	810	1,220	200	~10.0	~20	640	1,120
Cast steel (GM190, ICD5) below 285HB	JC8050	~100	~15.0	~45	910	1,910	~100	~15.0	~45	720	1,760
		150	~12.0	~30	810	1,460	150	~12.0	~30	640	1,340
		200	~10.0	~20	710	1,070	200	~10.0	~20	560	980
Tool & die steel (SKD61, SKD11) below 255HB	JC8050	~100	~15.0	~45	1,010	2,120	~100	~15.0	~45	800	1,960
		150	~12.0	~30	910	1,640	150	~12.0	~30	720	1,510
		200	~10.0	~20	810	1,220	200	~10.0	~20	640	1,120
Mold steel (HPM7, PX5, P20) 30-36 HRC	JC8118	~100	~15.0	~45	760	1,600	~100	~15.0	~45	600	1,470
		150	~12.0	~30	680	1,220	150	~12.0	~30	540	1,130
		200	~10.0	~20	610	920	200	~10.0	~20	480	840
Mold steel (NAK80, HPM1, P21) 38-43HRC	JC8118	~100	~15.0	~30	610	920	~100	~15.0	~30	480	840
		150	~12.0	~25	530	640	150	~12.0	~25	420	590
		200	~10.0	~15	450	410	200	~10.0	~15	360	380
Hardened die steel (SKD61, DAC, DHA) 42-52HRC	JC8118	~100	~15.0	~25	510	610	~100	~15.0	~25	400	560
		150	~12.0	~15	450	410	150	~12.0	~15	360	380
		200	~10.0	~8	400	240	200	~10.0	~8	320	220
Grey cast iron (FC250) 160-260HB	JC8118	~100	~15.0	~45	1,260	2,650	~100	~15.0	~45	990	2,430
		150	~12.0	~30	1,160	2,090	150	~12.0	~30	920	1,930
		200	~10.0	~20	1,060	1,590	200	~10.0	~20	840	1,470
Nodular cast iron (FCD700) 170-300HB	JC8118	~100	~15.0	~45	760	1,370	~100	~15.0	~45	600	1,260
		150	~12.0	~30	660	990	150	~12.0	~30	520	910
		200	~10.0	~20	560	670	200	~10.0	~20	440	620
Austenitic stainless steel (SUS304, 316, 317) 17Cr	JC8050	~100	~15.0	~45	610	730	~100	~15.0	~45	480	670
		150	~12.0	~30	560	500	150	~12.0	~30	440	460
		200	~10.0	~20	510	310	200	~10.0	~20	400	280
Ferritic & martensitic stainless steel (SUS403, 420J2, 430) 13Cr	JC8118	~100	~15.0	~45	910	1,640	~100	~15.0	~45	720	1,510
		150	~12.0	~30	810	1,220	150	~12.0	~30	640	1,120
		200	~10.0	~20	710	850	200	~10.0	~20	560	780

Note

1. Please adjust cutting conditions according to machine rigidity or work rigidity.
2. In case of chatter occurring, recommended to reduce a_p or rpm and keep feed per tooth.
3. a_p should be reduced when using on low rigidity machine.
4. Use air blow.

SIC-EVO

SSV Type

■ Recommended cutting conditions

● Facemill type - Shoulder milling

Material	Grade	Tool dia.(mm)									
		100					125				
		8N					8N				
		ℓ (mm)	a_p (mm)	$a_p \times a_e$ (mm ²)	n (min ⁻¹)	V_f (mm/min)	ℓ (mm)	a_p (mm)	$a_p \times a_e$ (mm ²)	n (min ⁻¹)	V_f (mm/min)
Carbon steel (S50C, S55C) below 250HB	JC8050	~100	~15.0	~45	640	1,790	~100	~15.0	~45	510	1,430
		150	~12.0	~30	570	1,370	150	~12.0	~30	460	1,100
		200	~10.0	~20	510	1,020	200	~10.0	~20	410	820
Cast steel (GM190, ICD5) below 285HB	JC8050	~100	~15.0	~45	570	1,600	~100	~15.0	~45	460	1,290
		150	~12.0	~30	510	1,220	150	~12.0	~30	410	980
		200	~10.0	~20	450	900	200	~10.0	~20	360	720
Tool & die steel (SKD61, SKD11) below 255HB	JC8050	~100	~15.0	~45	640	1,790	~100	~15.0	~45	510	1,430
		150	~12.0	~30	570	1,370	150	~12.0	~30	460	1,100
		200	~10.0	~20	510	1,020	200	~10.0	~20	410	820
Mold steel (HPM7, PX5, P20) 30-36 HRC	JC8118	~100	~15.0	~45	480	1,340	~100	~15.0	~45	380	1,060
		150	~12.0	~30	430	1,030	150	~12.0	~30	340	820
		200	~10.0	~20	380	760	200	~10.0	~20	310	620
Mold steel (NAK80, HPM1, P21) 38-43HRC	JC8118	~100	~15.0	~30	380	760	~100	~15.0	~30	310	620
		150	~12.0	~25	330	530	150	~12.0	~25	270	430
		200	~10.0	~15	290	350	200	~10.0	~15	230	280
Hardened die steel (SKD61, DAC, DHA) 42-52HRC	JC8118	~100	~15.0	~25	320	510	~100	~15.0	~25	250	400
		150	~12.0	~15	290	350	150	~12.0	~15	230	280
		200	~10.0	~8	250	200	200	~10.0	~8	200	160
Grey cast iron (FC250) 160-260HB	JC8118	~100	~15.0	~45	800	2,240	~100	~15.0	~45	640	1,790
		150	~12.0	~30	730	1,750	150	~12.0	~30	590	1,420
		200	~10.0	~20	670	1,340	200	~10.0	~20	530	1,060
Nodular cast iron (FCD700) 170-300HB	JC8118	~100	~15.0	~45	480	1,150	~100	~15.0	~45	380	910
		150	~12.0	~30	410	820	150	~12.0	~30	330	660
		200	~10.0	~20	350	560	200	~10.0	~20	280	450
Austenitic stainless steel (SUS304, 316, 317) 17Cr	JC8050	~100	~15.0	~45	380	610	~100	~15.0	~45	310	500
		150	~12.0	~30	350	420	150	~12.0	~30	280	340
		200	~10.0	~20	320	260	200	~10.0	~20	250	200
Ferritic & martensitic stainless steel (SUS403, 420J2, 430) 13Cr	JC8118	~100	~15.0	~45	570	1,370	~100	~15.0	~45	460	1,100
		150	~12.0	~30	510	1,020	150	~12.0	~30	410	820
		200	~10.0	~20	450	720	200	~10.0	~20	360	580

Note

1. Please adjust cutting conditions according to machine rigidity or work rigidity.
2. In case of chatter occurring, recommended to reduce a_p or rpm and keep feed per tooth.
3. a_p should be reduced when using on low rigidity machine.
4. Use air blow.

SIC-EVO**SSV Type**

■ Recommended cutting conditions

● Facemill type - Face milling

Material	Grade	Tool dia.(mm)									
		40					50				
		4N					5N				
		l (mm)	a_p (mm)	a_e (mm)	n (min ⁻¹)	V_f (mm/min)	l (mm)	a_p (mm)	a_e (mm)	n (min ⁻¹)	V_f (mm/min)
Carbon steel (S50C, S55C) below 250HB	JC8050	~100	~3.5	~40	1,190	1,430	~150	~4.0	~50	950	1,430
		150	~2.5	~32	1,030	1,030	200	~3.0	~40	830	1,040
		200	~1.5	~24	880	700	300	~2.0	~30	700	700
Cast steel (GM190, ICD5) below 285HB	JC8050	~100	~3.5	~40	1,190	1,430	~150	~4.0	~50	950	1,430
		150	~2.5	~32	1,030	1,030	200	~3.0	~40	830	1,040
		200	~1.5	~24	880	700	300	~2.0	~30	700	700
Tool & die steel (SKD61, SKD11) below 255HB	JC8050	~100	~3.5	~40	1,190	1,190	~150	~4.0	~50	950	1,190
		150	~2.5	~32	1,030	820	200	~3.0	~40	830	830
		200	~1.5	~24	880	530	300	~2.0	~30	700	530
Mold steel (HPM7, PX5, P20) 30-36 HRC	JC8118	~100	~3.5	~40	1,030	1,030	~150	~4.0	~50	830	1,040
		150	~2.5	~32	950	760	200	~3.0	~40	760	760
		200	~1.5	~24	880	530	300	~2.0	~30	700	530
Mold steel (NAK80, HPM1, P21) 38-43HRC	JC8118	~100	~2.5	~40	880	880	~150	~3.0	~50	700	880
		150	~2.0	~32	800	640	200	~2.5	~40	640	640
		200	~1.5	~24	720	430	300	~1.5	~30	570	430
Hardened die steel (SKD61, DAC, DHA) 42-52HRC	JC8118	~100	~2.0	~32	720	580	~150	~2.5	~40	570	570
		150	~1.5	~24	640	380	200	~2.0	~30	510	380
		200	~1.0	~16	560	220	300	~1.5	~20	450	230
Grey cast iron (FC250) 160-260HB	JC8118	~100	~5.5	~40	1,430	1,720	~150	~6.0	~50	1150	1,730
		150	~3.5	~32	1,190	1,190	200	~4.0	~40	950	1,190
		200	~1.5	~24	1,030	820	300	~2.0	~30	830	830
Nodular cast iron (FCD700) 170-300HB	JC8118	~100	~3.5	~40	1,030	1,030	~150	~4.0	~50	830	1,040
		150	~2.5	~32	950	760	200	~3.0	~40	760	760
		200	~1.5	~24	880	530	300	~2.0	~30	700	530
Austenitic stainless steel (SUS304, 316, 317) 17Cr	JC8050	~100	~3.5	~32	880	700	~150	~4.0	~40	700	700
		150	~2.5	~24	800	480	200	~3.0	~30	640	480
		200	~1.5	~16	720	290	300	~2.0	~20	570	290
Ferritic & martensitic stainless steel (SUS403, 420J2, 430) 13Cr	JC8118	~100	~3.5	~40	1,190	1,190	~150	~4.0	~50	950	1,190
		150	~2.5	~32	1,030	820	200	~3.0	~40	830	830
		200	~1.5	~24	880	530	300	~2.0	~30	700	530

Note

1. Please adjust cutting conditions according to machine rigidity or work rigidity.
2. In case of chatter occurring, recommended to reduce a_p or rpm and keep feed per tooth.
3. a_p should be reduced when using on low rigidity machine.
4. Use air blow.
5. In case of slot milling, apply 50% or less feed (V_f) from standard cutting condition table.

SIC-EVO

SSV Type

■ Recommended cutting conditions

● Facemill type - Face milling

Material	Grade	Tool dia.(mm)									
		63					80				
		6N					7N				
		f_z (mm)	a_p (mm)	a_e (mm)	n (min ⁻¹)	V_f (mm/min)	f_z (mm)	a_p (mm)	a_e (mm)	n (min ⁻¹)	V_f (mm/min)
Carbon steel (S50C, S55C) below 250HB	JC8050	~150	~4.0	~63	760	1,600	~150	~4.0	~80	600	1,470
		200	~3.0	~55	660	1,190	200	~3.0	~65	520	1,090
		300	~2.0	~40	560	840	300	~2.0	~50	440	770
Cast steel (GM190, ICD5) below 285HB	JC8050	~150	~4.0	~63	760	1,600	~150	~4.0	~80	600	1,470
		200	~3.0	~55	660	1,190	200	~3.0	~65	520	1,090
		300	~2.0	~40	560	840	300	~2.0	~50	440	770
Tool & die steel (SKD61, SKD11) below 255HB	JC8050	~150	~4.0	~63	760	1,370	~150	~4.0	~80	600	1,260
		200	~3.0	~55	660	990	200	~3.0	~65	520	910
		300	~2.0	~40	560	670	300	~2.0	~50	440	620
Mold steel (HPM7, PX5, P20) 30-36 HRC	JC8118	~150	~4.0	~63	660	1,190	~150	~4.0	~80	520	1,090
		200	~3.0	~55	610	920	200	~3.0	~65	480	840
		300	~2.0	~40	560	670	300	~2.0	~50	440	620
Mold steel (NAK80, HPM1, P21) 38-43HRC	JC8118	~150	~3.0	~63	560	840	~150	~3.0	~80	440	770
		200	~2.5	~55	510	610	200	~2.5	~65	400	560
		300	~1.5	~40	450	410	300	~1.5	~50	360	380
Hardened die steel (SKD61, DAC, DHA) 42-52HRC	JC8118	~150	~2.5	~55	450	540	~150	~2.5	~65	360	500
		200	~2.0	~40	400	360	200	~2.0	~50	320	340
		300	~1.5	~32	350	210	300	~1.5	~35	280	200
Grey cast iron (FC250) 160-260HB	JC8118	~150	~6.0	~63	910	1,910	~150	~6.0	~80	720	1,760
		200	~4.0	~55	760	1,370	200	~4.0	~65	600	1,260
		300	~2.0	~40	660	990	300	~2.0	~50	520	910
Nodular cast iron (FCD700) 170-300HB	JC8118	~150	~4.0	~63	660	1,190	~150	~4.0	~80	520	1,090
		200	~3.0	~55	610	920	200	~3.0	~65	480	840
		300	~2.0	~40	560	670	300	~2.0	~50	440	620
Austenitic stainless steel (SUS304, 316, 317) 17Cr	JC8050	~150	~4.0	~55	560	670	~150	~4.0	~65	440	620
		200	~3.0	~40	510	460	200	~3.0	~50	400	420
		300	~2.0	~32	450	270	300	~2.0	~35	360	250
Ferritic & martensitic stainless steel (SUS403, 420J2, 430) 13Cr	JC8118	~150	~4.0	~63	760	1,370	~150	~4.0	~80	600	1,260
		200	~3.0	~55	660	990	200	~3.0	~65	520	910
		300	~2.0	~40	560	670	300	~2.0	~50	440	620

Note

1. Please adjust cutting conditions according to machine rigidity or work rigidity.
2. In case of chatter occurring, recommended to reduce a_p or rpm and keep feed per tooth.
3. a_p should be reduced when using on low rigidity machine.
4. Use air blow.
5. In case of slot milling , apply 50% or less feed (V_f) from standard cutting condition table.

SIC-EVO**SSV Type**

■ Recommended cutting conditions

● Facemill type - Face milling

Material	Grade	Tool dia.(mm)									
		100					125				
		8N					8N				
		ℓ (mm)	a_p (mm)	a_e (mm)	n (min ⁻¹)	V_f (mm/min)	ℓ (mm)	a_p (mm)	a_e (mm)	n (min ⁻¹)	V_f (mm/min)
Carbon steel (S50C, S55C) below 250HB	JC8050	~150	~4.0	~100	480	1,340	~150	~4.0	~125	380	1,060
		200	~3.0	~80	410	980	200	~3.0	~100	330	790
		300	~2.0	~60	350	700	300	~2.0	~75	280	560
Cast steel (GM190, ICD5) below 285HB	JC8050	~150	~4.0	~100	480	1,340	~150	~4.0	~125	380	1,060
		200	~3.0	~80	410	980	200	~3.0	~100	330	790
		300	~2.0	~60	350	700	300	~2.0	~75	280	560
Tool & die steel (SKD61, SKD11) below 255HB	JC8050	~150	~4.0	~100	480	1,150	~150	~4.0	~125	380	910
		200	~3.0	~80	410	820	200	~3.0	~100	330	660
		300	~2.0	~60	350	560	300	~2.0	~75	280	450
Mold steel (HPM7, PX5, P20) 30-36 HRC	JC8118	~150	~4.0	~100	410	980	~150	~4.0	~125	330	790
		200	~3.0	~80	380	760	200	~3.0	~100	310	620
		300	~2.0	~60	350	560	300	~2.0	~75	280	450
Mold steel (NAK80, HPM1, P21) 38-43HRC	JC8118	~150	~3.0	~100	350	700	~150	~3.0	~125	280	560
		200	~2.5	~80	320	510	200	~2.5	~100	250	400
		300	~1.5	~60	290	350	300	~1.5	~75	230	280
Hardened die steel (SKD61, DAC, DHA) 42-52HRC	JC8118	~150	~2.5	~80	290	460	~150	~2.5	~100	230	370
		200	~2.0	~60	250	300	200	~2.0	~75	200	240
		300	~1.5	~40	220	180	300	~1.5	~50	180	140
Grey cast iron (FC250) 160-260HB	JC8118	~150	~6.0	~100	570	1,600	~150	~6.0	~125	460	1,290
		200	~4.0	~80	480	1,150	200	~4.0	~100	380	910
		300	~2.0	~60	410	820	300	~2.0	~75	330	660
Nodular cast iron (FCD700) 170-300HB	JC8118	~150	~4.0	~100	410	980	~150	~4.0	~125	330	790
		200	~3.0	~80	380	760	200	~3.0	~100	310	620
		300	~2.0	~60	350	560	300	~2.0	~75	280	450
Austenitic stainless steel (SUS304, 316, 317) 17Cr	JC8050	~150	~4.0	~80	350	560	~150	~4.0	~100	280	450
		200	~3.0	~60	320	380	200	~3.0	~75	250	300
		300	~2.0	~40	290	230	300	~2.0	~50	230	180
Ferritic & martensitic stainless steel (SUS403, 420J2, 430) 13Cr	JC8118	~150	~4.0	~100	480	1,150	~150	~4.0	~125	380	910
		200	~3.0	~80	410	820	200	~3.0	~100	330	660
		300	~2.0	~60	350	560	300	~2.0	~75	280	450

Note

1. Please adjust cutting conditions according to machine rigidity or work rigidity.
2. In case of chatter occurring, recommended to reduce a_p or rpm and keep feed per tooth.
3. a_p should be reduced when using on low rigidity machine.
4. Use air blow.
5. In case of slot milling, apply 50% or less feed (V_f) from standard cutting condition table.

SIC-EVO**SSV Type**

■ Recommended cutting conditions

● Endmill type - Shoulder milling

Material	Grade	Tool dia.(mm)									
		25					30				
		2N					3N				
		ℓ (mm)	a _p (mm)	a _p ×a _e (mm ²)	n (min ⁻¹)	V _f (mm/min)	ℓ (mm)	a _p (mm)	a _p ×a _e (mm ²)	n (min ⁻¹)	V _f (mm/min)
Carbon steel (S50C, S55C) below 250HB	JC8050	60	~10.0	~15	2,550	1,380	70	~12.0	~24	2,120	1,720
		100	~7.0	~10	2,290	1,050	120	~9.0	~18	1,910	1,320
Cast steel (GM190, ICD5) below 285HB	JC8050	60	~10.0	~15	2,290	1,240	70	~12.0	~24	1,910	1,550
		100	~7.0	~10	2,040	940	120	~9.0	~18	1,700	1,170
Tool & die steel (SKD61, SKD11) below 255HB	JC8050	60	~10.0	~15	2,550	1,380	70	~12.0	~24	2,120	1,720
		100	~7.0	~10	2,290	1,050	120	~9.0	~18	1,910	1,320
Mold steel (HPM7, PX5, P20) 30-36 HRC	JC8118	60	~10.0	~15	1,910	1,030	70	~12.0	~24	1,590	1,290
		100	~7.0	~10	1,720	790	120	~9.0	~18	1,430	990
Mold steel (NAK80, HPM1, P21) 38-43HRC	JC8118	60	~10.0	~12	1,530	700	70	~12.0	~18	1,270	880
		100	~7.0	~6	1,340	480	120	~9.0	~13	1,110	600
Hardened die steel (SKD61, DAC, DHA) 42-52HRC	JC8118	60	~10.0	~8	1,270	460	70	~12.0	~12	1,060	570
		100	~7.0	~4	1,150	320	120	~9.0	~8	950	400
Grey cast iron (FC250) 160-260HB	JC8118	60	~10.0	~15	3,180	1,720	70	~12.0	~24	2,650	2,150
		100	~7.0	~10	2,930	1,350	120	~9.0	~18	2,440	1,680
Nodular cast iron (FCD700) 170-300HB	JC8118	60	~10.0	~15	1,910	880	70	~12.0	~24	1,590	1,100
		100	~7.0	~10	1,660	600	120	~9.0	~18	1,380	750
Austenitic stainless steel (SUS304, 316, 317) 17Cr	JC8050	60	~10.0	~15	1,530	550	70	~12.0	~24	1,270	690
		100	~7.0	~10	1,400	390	120	~9.0	~18	1,170	490
Ferritic & martensitic stainless steel (SUS403, 420J2, 430) 13Cr	JC8118	60	~10.0	~15	2,290	1,050	70	~12.0	~24	1,910	1,320
		100	~7.0	~10	2,040	730	120	~9.0	~18	1,700	920

Note

1. Please adjust cutting conditions according to machine rigidity or work rigidity.
2. In case of chatter occurring, recommended to reduce a_p or rpm and keep feed per tooth.
3. a_p should be reduced when using on low rigidity machine.
4. Use air blow.

SIC-EVO**SSV Type**

■ Recommended cutting conditions

● Endmill type - Shoulder milling

Material	Grade	Tool dia.(mm)									
		32					40				
		3N					4N				
		ℓ (mm)	a_p (mm)	$a_p \times a_e$ (mm ²)	n (min ⁻¹)	V_f (mm/min)	ℓ (mm)	a_p (mm)	$a_p \times a_e$ (mm ²)	n (min ⁻¹)	V_f (mm/min)
Carbon steel (S50C, S55C) below 250HB	JC8050	70	~12.0	~24	1,990	1,610	50	~15.0	~30	1,590	1,720
		120	~9.0	~18	1,790	1,240	100	~10.0	~20	1,430	1,320
Cast steel (GM190, ICD5) below 285HB	JC8050	70	~12.0	~24	1,790	1,450	50	~15.0	~30	1,430	1,540
		120	~9.0	~18	1,590	1,100	100	~10.0	~20	1,270	1,170
Tool & die steel (SKD61, SKD11) below 255HB	JC8050	70	~12.0	~24	1,990	1,610	50	~15.0	~30	1,590	1,720
		120	~9.0	~18	1,790	1,240	100	~10.0	~20	1,430	1,320
Mold steel (HPM7, PX5, P20) 30-36 HRC	JC8118	70	~12.0	~24	1,490	1,210	50	~15.0	~30	1,190	1,290
		120	~9.0	~18	1,340	920	100	~10.0	~20	1,070	980
Mold steel (NAK80, HPM1, P21) 38-43HRC	JC8118	70	~12.0	~18	1,190	820	50	~15.0	~20	950	870
		120	~9.0	~13	1,040	560	100	~10.0	~15	840	600
Hardened die steel (SKD61, DAC, DHA) 42-52HRC	JC8118	70	~12.0	~12	990	530	50	~12.0	~12	800	580
		120	~9.0	~8	900	380	100	~10.0	~8	720	400
Grey cast iron (FC250) 160-260HB	JC8118	70	~12.0	~24	2,490	2,020	50	~15.0	~30	1,990	2,150
		120	~9.0	~18	2,290	1,580	100	~10.0	~20	1,830	1,680
Nodular cast iron (FCD700) 170-300HB	JC8118	70	~12.0	~24	1,490	1,030	50	~15.0	~30	1,190	1,090
		120	~9.0	~18	1,290	700	100	~10.0	~20	1,030	740
Austenitic stainless steel (SUS304, 316, 317) 17Cr	JC8050	70	~12.0	~24	1,190	640	50	~15.0	~30	950	680
		120	~9.0	~18	1,090	460	100	~10.0	~20	880	490
Ferritic & martensitic stainless steel (SUS403, 420J2, 430) 13Cr	JC8118	70	~12.0	~24	1,790	1,240	50	~15.0	~30	1,430	1,320
		120	~9.0	~18	1,590	860	100	~10.0	~20	1,270	910

Note

1. Please adjust cutting conditions according to machine rigidity or work rigidity.
2. In case of chatter occurring, recommended to reduce a_p or rpm and keep feed per tooth.
3. a_p should be reduced when using on low rigidity machine.
4. Use air blow.

SIC-EVO**SSV Type**

■ Recommended cutting conditions

● Endmill type - Shoulder milling

Material	Grade	Tool dia.(mm)				
		50				
		5N				
		ℓ (mm)	a_p (mm)	$a_p \times a_e$ (mm ²)	n (min ⁻¹)	V_f (mm/min)
Carbon steel (S50C, S55C) below 250HB	JC8050	40	~15.0	~40	1,270	1,710
Cast steel (GM190, ICD5) below 285HB	JC8050	40	~15.0	~40	1,150	1,550
Tool & die steel (SKD61, SKD11) below 255HB	JC8050	40	~15.0	~40	1,270	1,710
Mold steel (HPM7, PX5, P20) 30-36 HRC	JC8118	40	~15.0	~40	950	1,280
Mold steel (NAK80, HPM1, P21) 38-43HRC	JC8118	40	~15.0	~30	760	870
Hardened die steel (SKD61, DAC, DHA) 42-52HRC	JC8118	40	~15.0	~18	640	580
Grey cast iron (FC250) 160-260HB	JC8118	40	~15.0	~40	1,590	2,150
Nodular cast iron (FCD700) 170-300HB	JC8118	40	~15.0	~40	950	1,090
Austenitic stainless steel (SUS304, 316, 317) 17Cr	JC8050	40	~15.0	~40	760	680
Ferritic & martensitic stainless steel (SUS403, 420J2, 430) 13Cr	JC8118	40	~15.0	~40	1,150	1,320

Note

1. Please adjust cutting conditions according to machine rigidity or work rigidity.
2. In case of chatter occurring, recommended to reduce a_p or rpm and keep feed per tooth.
3. a_p should be reduced when using on low rigidity machine.
4. Use air blow.

SIC-EVO**SSV Type**

■ Recommended cutting conditions

● Endmill type - Face milling

Material	Grade	Tool dia.(mm)									
		25					30				
		2N					3N				
		ℓ (mm)	a_p (mm)	a_e (mm)	n (min ⁻¹)	V_f (mm/min)	ℓ (mm)	a_p (mm)	a_e (mm)	n (min ⁻¹)	V_f (mm/min)
Carbon steel (S50C, S55C) below 250HB	JC8050	~60	~3.0	~25	1,910	1,030	~70	~3.5	~30	1,590	1,290
		100	~2.0	~20	1,660	760	120	~2.5	~24	1,380	950
Cast steel (GM190, JCD5) below 285HB	JC8050	~60	~3.0	~25	1,910	1,030	~70	~3.5	~30	1,590	1,290
		100	~2.0	~20	1,660	760	120	~2.5	~24	1,380	950
Tool & die steel (SKD61, SKD11) below 255HB	JC8050	~60	~3.0	~25	1,910	880	~70	~3.5	~30	1,590	1,100
		100	~2.0	~20	1,660	600	120	~2.5	~24	1,380	750
Mold steel (HPM7, PX5, P20) 30-36 HRC	JC8118	~60	~3.0	~25	1,660	760	~70	~3.5	~30	1,380	950
		100	~2.0	~20	1,530	550	120	~2.5	~24	1,270	690
Mold steel (NAK80, HPM1, P21) 38-43HRC	JC8118	~60	~2.0	~25	1,400	640	~70	~2.5	~30	1,170	810
		100	~1.5	~20	1,270	460	120	~2.0	~24	1,060	570
Hardened die steel (SKD61, DAC, DHA) 42-52HRC	JC8118	~60	~1.5	~20	1,150	410	~70	~2.0	~24	950	510
		100	~1.0	~15	1,020	290	120	~1.5	~18	850	360
Grey cast iron (FC250) 160-260HB	JC8118	~60	~5.0	~25	2,550	1,380	~70	~5.5	~30	2,120	1,720
		100	~3.0	~20	2,290	1,050	120	~3.5	~24	1,910	1,320
Nodular cast iron (FCD700) 170-300HB	JC8118	~60	~3.0	~25	1,660	760	~70	~3.5	~30	1,380	950
		100	~2.0	~20	1,530	550	120	~2.5	~24	1,270	690
Austenitic stainless steel (SUS304, 316, 317) 17Cr	JC8050	~60	~3.0	~20	1,400	500	~70	~3.5	~24	1,170	630
		100	~2.0	~15	1,270	360	120	~2.5	~18	1,060	450
Ferritic & martensitic stainless steel (SUS403, 420J2, 430) 13Cr	JC8118	~60	~3.0	~25	1,910	880	~70	~3.5	~30	1,590	1,100
		100	~2.0	~20	1,660	600	120	~2.5	~24	1,380	750

Note

1. Please adjust cutting conditions according to machine rigidity or work rigidity.
2. In case of chatter occurring, recommended to reduce a_p or rpm and keep feed per tooth.
3. a_p should be reduced when using on low rigidity machine.
4. Use air blow.
5. In case of slot milling, apply 50% or less feed (V_f) from standard cutting condition table.

SIC-EVO

SSV Type

■ Recommended cutting conditions

● Endmill type - Face milling

Material	Grade	Tool dia.(mm)									
		32					40				
		3N					4N				
		l (mm)	a_p (mm)	a_e (mm)	n (min ⁻¹)	V_f (mm/min)	l (mm)	a_p (mm)	a_e (mm)	n (min ⁻¹)	V_f (mm/min)
Carbon steel (S50C, S55C) below 250HB	JC8050	~70	~3.5	~32	1,490	1,210	~50	~3.5	~40	1,190	1,290
		120	~2.5	~26	1,290	890	100	~2.5	~32	1,030	950
Cast steel (GM190, ICD5) below 285HB	JC8050	~70	~3.5	~32	1,490	1,210	~50	~3.5	~40	1,190	1,290
		120	~2.5	~26	1,290	890	100	~2.5	~32	1,030	950
Tool & die steel (SKD61, SKD11) below 255HB	JC8050	~70	~3.5	~32	1,490	1,030	~50	~3.5	~40	1,190	1,090
		120	~2.5	~26	1,290	700	100	~2.5	~32	1,030	740
Mold steel (HPM7, PX5, P20) 30-36 HRC	JC8118	~70	~3.5	~32	1,290	890	~50	~3.5	~40	1,030	950
		120	~2.5	~26	1,190	640	100	~2.5	~32	950	680
Mold steel (NAK80, HPM1, P21) 38-43HRC	JC8118	~70	~2.5	~32	1,090	750	~50	~2.5	~40	880	810
		120	~2.0	~26	990	530	100	~2.0	~32	800	580
Hardened die steel (SKD61, DAC, DHA) 42-52HRC	JC8118	~70	~2.0	~26	900	490	~50	~2.0	~32	720	520
		120	~1.5	~19	800	340	100	~1.5	~24	640	360
Grey cast iron (FC250) 160-260HB	JC8118	~70	~5.5	~32	1,990	1,610	~50	~5.5	~40	1,590	1,720
		120	~3.5	~26	1,790	1,240	100	~3.5	~32	1,430	1,320
Nodular cast iron (FCD700) 170-300HB	JC8118	~70	~3.5	~32	1,290	890	~50	~3.5	~40	1,030	950
		120	~2.5	~26	1,190	640	100	~2.5	~32	950	680
Austenitic stainless steel (SUS304, 316, 317) 17Cr	JC8050	~70	~3.5	~26	1,090	590	~50	~3.5	~32	880	630
		120	~2.5	~19	990	420	100	~2.5	~24	800	450
Ferritic & martensitic stainless steel (SUS403, 420J2, 430) 13Cr	JC8118	~70	~3.5	~32	1,490	1,030	~50	~3.5	~40	1,190	1,090
		120	~2.5	~26	1,290	700	100	~2.5	~32	1,030	740

Note

1. Please adjust cutting conditions according to machine rigidity or work rigidity.
2. In case of chatter occurring, recommended to reduce a_p or rpm and keep feed per tooth.
3. a_p should be reduced when using on low rigidity machine.
4. Use air blow.
5. In case of slot milling , apply 50% or less feed (V_f) from standard cutting condition table.

SIC-EVO**SSV Type**

■ Recommended cutting conditions

● Endmill type - Face milling

Material	Grade	Tool dia.(mm)				
		50				
		5N				
		l (mm)	a_p (mm)	a_e (mm)	n (min ⁻¹)	V_f (mm/min)
Carbon steel (S50C, S55C) below 250HB	JC8050	40	~4.0	~50	950	1,280
Cast steel (GM190, ICD5) below 285HB	JC8050	40	~4.0	~50	950	1,280
Tool & die steel (SKD61, SKD11) below 255HB	JC8050	40	~4.0	~50	950	1,090
Mold steel (HPM7, PX5, P20) 30-36 HRC	JC8118	40	~4.0	~50	830	950
Mold steel (NAK80, HPM1, P21) 38-43HRC	JC8118	40	~3.0	~50	700	810
Hardened die steel (SKD61, DAC, DHA) 42-52HRC	JC8118	40	~2.5	~40	570	510
Grey cast iron (FC250) 160-260HB	JC8118	40	~6.0	~50	1,270	1,710
Nodular cast iron (FCD700) 170-300HB	JC8118	40	~4.0	~50	830	950
Austenitic stainless steel (SUS304, 316, 317) 17Cr	JC8050	40	~4.0	~40	700	630
Ferritic & martensitic stainless steel (SUS403, 420J2, 430) 13Cr	JC8118	40	~4.0	~50	950	1,090

Note

1. Please adjust cutting conditions according to machine rigidity or work rigidity.
2. In case of chatter occurring, recommended to reduce a_p or rpm and keep feed per tooth.
3. a_p should be reduced when using on low rigidity machine.
4. Use air blow.
5. In case of slot milling , apply 50% or less feed (V_f) from standard cutting condition table.

SIC-EVO

SSV Type

■ Recommended cutting conditions

● Modular head type + MSN carbide shank - Shoulder milling

Material	Grade	Tool dia.(mm)									
		25					28				
		2N					2N				
		ℓ (mm)	ap (mm)	ap×ae (mm ²)	n (min ⁻¹)	Vf (mm/min)	ℓ (mm)	ap (mm)	ap×ae (mm ²)	n (min ⁻¹)	Vf (mm/min)
Carbon steel (S50C, S55C) below 250HB	JC8050	~90	~10.0	~15	2,550	1,530	~90	~10.0	~15	2,270	1,360
		140	~7.0	~10	2,290	1,150	140	~7.0	~10	2,050	1,030
		210	~4.0	~5	2,040	820	210	~4.0	~5	1,820	730
Cast steel (GM190, ICD5) below 285HB	JC8050	~90	~10.0	~15	2,290	1,370	~90	~10.0	~15	2,050	1,230
		140	~7.0	~10	2,040	1,020	140	~7.0	~10	1,820	910
		210	~4.0	~5	1,780	710	210	~4.0	~5	1,590	640
Tool & die steel (SKD61, SKD11) below 255HB	JC8050	~90	~10.0	~15	2,550	1,530	~90	~10.0	~15	2,270	1,360
		140	~7.0	~10	2,290	1,150	140	~7.0	~10	2,050	1,030
		210	~4.0	~5	2,040	820	210	~4.0	~5	1,820	730
Mold steel (HPM7, PX5, P20) 30-36 HRC	JC8118	~90	~10.0	~15	1,910	1,150	~90	~10.0	~15	1,710	1,030
		140	~7.0	~10	1,720	860	140	~7.0	~10	1,530	770
		210	~4.0	~5	1,530	610	210	~4.0	~5	1,360	540
Mold steel (NAK80, HPM1, P21) 38-43HRC	JC8118	~90	~10.0	~12	1,530	770	~90	~10.0	~12	1,360	680
		140	~7.0	~6	1,340	540	140	~7.0	~6	1,190	480
		210	~4.0	~2	1,150	350	210	~4.0	~2	1,020	310
Hardened die steel (SKD61, DAC, DHA) 42-52HRC	JC8118	~90	~10.0	~8	1,270	510	~90	~10.0	~8	1,140	460
		140	~7.0	~4	1,150	350	140	~7.0	~4	1,020	310
		210	~4.0	~2	1,020	200	210	~4.0	~2	910	180
Grey cast iron (FC250) 160-260HB	JC8118	~90	~10.0	~15	3,180	1,910	~90	~10.0	~15	2,840	1,700
		140	~7.0	~10	2,930	1,470	140	~7.0	~10	2,610	1,310
		210	~4.0	~5	2,670	1,070	210	~4.0	~5	2,390	960
Nodular cast iron (FCD700) 170-300HB	JC8118	~90	~10.0	~15	1,910	960	~90	~10.0	~15	1,710	860
		140	~7.0	~10	1,660	660	140	~7.0	~10	1,480	590
		210	~4.0	~5	1,400	420	210	~4.0	~5	1,250	380
Austenitic stainless steel (SUS304, 316, 317) 17Cr	JC8050	~90	~10.0	~15	1,530	610	~90	~10.0	~15	1,360	540
		140	~7.0	~10	1,400	420	140	~7.0	~10	1,250	380
		210	~4.0	~5	1,270	250	210	~4.0	~5	1,140	230
Ferritic & martensitic stainless steel (SUS403, 420J2, 430) 13Cr	JC8118	~90	~10.0	~15	2,290	1,150	~90	~10.0	~15	2,050	1,030
		140	~7.0	~10	2,040	820	140	~7.0	~10	1,820	730
		210	~4.0	~5	1,780	530	210	~4.0	~5	1,590	480

Note

1. Please adjust cutting conditions according to machine rigidity or work rigidity.
2. In case of chatter occurring, recommended to reduce ap or rpm and keep feed per tooth.
3. ap should be reduced when using on low rigidity machine.
4. Use air blow.

SIC-EVO**SSV Type**

■ Recommended cutting conditions

● Modular head type + MSN carbide shank - Shoulder milling

Material	Grade	Tool dia.(mm)									
		30					32				
		3N					3N				
		ℓ (mm)	a_p (mm)	$a_p \times a_e$ (mm ²)	n (min ⁻¹)	V_f (mm/min)	ℓ (mm)	a_p (mm)	$a_p \times a_e$ (mm ²)	n (min ⁻¹)	V_f (mm/min)
Carbon steel (S50C, S55C) below 250HB	JC8050	~100	~12.0	~24	2,120	1,910	~100	~12.0	~24	1,990	1,790
		150	~9.0	~18	1,910	1,430	150	~9.0	~18	1,790	1,340
		210	~6.0	~9	1,700	1,020	210	~6.0	~9	1,590	950
Cast steel (GM190, ICD5) below 285HB	JC8050	~100	~12.0	~24	1,910	1,720	~100	~12.0	~24	1,790	1,610
		150	~9.0	~18	1,700	1,280	150	~9.0	~18	1,590	1,190
		210	~6.0	~9	1,490	890	210	~6.0	~9	1,390	830
Tool & die steel (SKD61, SKD11) below 255HB	JC8050	~100	~12.0	~24	2,120	1,910	~100	~12.0	~24	1,990	1,790
		150	~9.0	~18	1,910	1,430	150	~9.0	~18	1,790	1,340
		210	~6.0	~9	1,700	1,020	210	~6.0	~9	1,590	950
Mold steel (HPM7, PX5, P20) 30-36 HRC	JC8118	~100	~12.0	~24	1,590	1,430	~100	~12.0	~24	1,490	1,340
		150	~9.0	~18	1,430	1,070	150	~9.0	~18	1,340	1,010
		210	~6.0	~9	1,270	760	210	~6.0	~9	1,190	710
Mold steel (NAK80, HPM1, P21) 38-43HRC	JC8118	~100	~12.0	~18	1,270	950	~100	~12.0	~18	1,190	890
		150	~9.0	~13	1,110	670	150	~9.0	~13	1,040	620
		210	~6.0	~7	950	430	210	~6.0	~7	900	410
Hardened die steel (SKD61, DAC, DHA) 42-52HRC	JC8118	~100	~12.0	~12	1,060	640	~100	~12.0	~12	990	590
		150	~9.0	~8	950	430	150	~9.0	~8	900	410
		210	~6.0	~3	850	260	210	~6.0	~3	800	240
Grey cast iron (FC250) 160-260HB	JC8118	~100	~12.0	~24	2,650	2,390	~100	~12.0	~24	2,490	2,240
		150	~9.0	~18	2,440	1,830	150	~9.0	~18	2,290	1,720
		210	~6.0	~12	2,230	1,340	210	~6.0	~12	2,090	1,250
Nodular cast iron (FCD700) 170-300HB	JC8118	~100	~12.0	~24	1,590	1,190	~100	~12.0	~24	1,490	1,120
		150	~9.0	~18	1,380	830	150	~9.0	~18	1,290	770
		210	~6.0	~9	1,170	530	210	~6.0	~9	1,090	490
Austenitic stainless steel (SUS304, 316, 317) 17Cr	JC8050	~100	~12.0	~24	1,270	760	~100	~12.0	~24	1,190	710
		150	~9.0	~18	1,170	530	150	~9.0	~18	1,090	490
		210	~6.0	~9	1,060	320	210	~6.0	~9	990	300
Ferritic & martensitic stainless steel (SUS403, 420J2, 430) 13Cr	JC8118	~100	~12.0	~24	1,910	1,430	~100	~12.0	~24	1,790	1,340
		150	~9.0	~18	1,700	1,020	150	~9.0	~18	1,590	950
		210	~6.0	~9	1,490	670	210	~6.0	~9	1,390	630

Note

1. Please adjust cutting conditions according to machine rigidity or work rigidity.
2. In case of chatter occurring, recommended to reduce a_p or rpm and keep feed per tooth.
3. a_p should be reduced when using on low rigidity machine.
4. Use air blow.

SIC-EVO

SSV Type

- Recommended cutting conditions
- Modular head type + MSN carbide shank - Shoulder milling

Material	Grade	Tool dia.(mm)									
		35					40				
		3N					4N				
		ℓ (mm)	a_p (mm)	$a_p \times a_e$ (mm ²)	n (min ⁻¹)	V_f (mm/min)	ℓ (mm)	a_p (mm)	$a_p \times a_e$ (mm ²)	n (min ⁻¹)	V_f (mm/min)
Carbon steel (S50C, S55C) below 250HB	JC8050	~100	~12.0	~24	1,820	1,640	~100	~15.0	~30	1,590	1,910
		150	~9.0	~18	1,640	1,230	150	~10.0	~20	1,430	1,430
		210	~6.0	~9	1,460	880	210	~8.0	~12	1,270	1,020
Cast steel (GM190, ICD5) below 285HB	JC8050	~100	~12.0	~24	1,640	1,480	~100	~15.0	~30	1,430	1,720
		150	~9.0	~18	1,460	1,100	150	~10.0	~20	1,270	1,270
		210	~6.0	~9	1,270	760	210	~8.0	~12	1,110	890
Tool & die steel (SKD61, SKD11) below 255HB	JC8050	~100	~12.0	~24	1,820	1,640	~100	~15.0	~30	1,590	1,910
		150	~9.0	~18	1,640	1,230	150	~10.0	~20	1,430	1,430
		210	~6.0	~9	1,460	880	210	~8.0	~12	1,270	1,020
Mold steel (HPM7, PX5, P20) 30-36 HRC	JC8118	~100	~12.0	~24	1,360	1,220	~100	~15.0	~30	1,190	1,430
		150	~9.0	~18	1,230	920	150	~10.0	~20	1,070	1,070
		210	~6.0	~9	1,090	650	210	~8.0	~12	950	760
Mold steel (NAK80, HPM1, P21) 38-43HRC	JC8118	~100	~12.0	~18	1,090	820	~100	~15.0	~20	950	950
		150	~9.0	~13	950	570	150	~10.0	~15	840	670
		210	~6.0	~7	820	370	210	~8.0	~8	720	430
Hardened die steel (SKD61, DAC, DHA) 42-52HRC	JC8118	~100	~12.0	~12	910	550	~100	~12.0	~12	800	640
		150	~9.0	~8	820	370	150	~10.0	~8	720	430
		210	~6.0	~3	730	220	210	~8.0	~3	640	260
Grey cast iron (FC250) 160-260HB	JC8118	~100	~12.0	~24	2,270	2,040	~100	~15.0	~30	1,990	2,390
		150	~9.0	~18	2,090	1,570	150	~10.0	~20	1,830	1,830
		210	~6.0	~12	1,910	1,150	210	~8.0	~12	1,670	1,340
Nodular cast iron (FCD700) 170-300HB	JC8118	~100	~12.0	~24	1,360	1,020	~100	~15.0	~30	1,190	1,190
		150	~9.0	~18	1,180	710	150	~10.0	~20	1,030	820
		210	~6.0	~9	1,000	450	210	~8.0	~12	880	530
Austenitic stainless steel (SUS304, 316, 317) 17Cr	JC8050	~100	~12.0	~24	1,090	650	~100	~15.0	~30	950	760
		150	~9.0	~18	1,000	450	150	~10.0	~20	880	530
		210	~6.0	~9	910	270	210	~8.0	~12	800	320
Ferritic & martensitic stainless steel (SUS403, 420J2, 430) 13Cr	JC8118	~100	~12.0	~24	1,640	1,230	~100	~15.0	~30	1,430	1,430
		150	~9.0	~18	1,460	880	150	~10.0	~20	1,270	1,020
		210	~6.0	~9	1,270	570	210	~8.0	~12	1,110	670

Note

1. Please adjust cutting conditions according to machine rigidity or work rigidity.
2. In case of chatter occurring, recommended to reduce a_p or rpm and keep feed per tooth.
3. a_p should be reduced when using on low rigidity machine.
4. Use air blow.

SIC-EVO**SSV Type**

■ Recommended cutting conditions

● Modular head type + MSN carbide shank - Face milling

Material	Grade	Tool dia.(mm)									
		25					28				
		2N					2N				
		ℓ (mm)	a _p (mm)	a _e (mm)	n (min ⁻¹)	V _f (mm/min)	ℓ (mm)	a _p (mm)	a _e (mm)	n (min ⁻¹)	V _f (mm/min)
Carbon steel (S50C, S55C) below 250HB	JC8050	~90	~3.0	~25	1,910	1,150	~90	~3.0	~28	1,710	1,030
		140	~2.0	~20	1,660	830	140	~2.0	~22	1,480	740
		210	~1.0	~15	1,400	560	210	~1.0	~17	1,250	500
Cast steel (GM190, ICD5) below 285HB	JC8050	~90	~3.0	~25	1,910	1,150	~90	~3.0	~28	1,710	1,030
		140	~2.0	~20	1,660	830	140	~2.0	~22	1,480	740
		210	~1.0	~15	1,400	560	210	~1.0	~17	1,250	500
Tool & die steel (SKD61, SKD11) below 255HB	JC8050	~90	~3.0	~25	1,910	960	~90	~3.0	~28	1,710	860
		140	~2.0	~20	1,660	660	140	~2.0	~22	1,480	590
		210	~1.0	~15	1,400	420	210	~1.0	~17	1,250	380
Mold steel (HPM7, PX5, P20) 30-36 HRC	JC8118	~90	~3.0	~25	1,660	830	~90	~3.0	~28	1,480	740
		140	~2.0	~20	1,530	610	140	~2.0	~22	1,360	540
		210	~1.0	~15	1,400	420	210	~1.0	~17	1,250	380
Mold steel (NAK80, HPM1, P21) 38-43HRC	JC8118	~90	~2.0	~25	1,400	700	~90	~2.0	~28	1,250	630
		140	~1.5	~20	1,270	510	140	~1.5	~22	1,140	460
		210	~1.0	~15	1,150	350	210	~1.0	~17	1,020	310
Hardened die steel (SKD61, DAC, DHA) 42-52HRC	JC8118	~90	~1.5	~20	1,150	460	~90	~1.5	~22	1,020	410
		140	~1.0	~15	1,020	310	140	~1.0	~17	910	270
		210	~0.5	~10	890	180	210	~0.5	~11	800	160
Grey cast iron (FC250) 160-260HB	JC8118	~90	~5.0	~25	2,550	1,530	~90	~5.0	~28	2,270	1,360
		140	~3.0	~20	2,290	1,150	140	~3.0	~22	2,050	1,030
		210	~1.0	~15	2,040	820	210	~1.0	~17	1,820	730
Nodular cast iron (FCD700) 170-300HB	JC8118	~90	~3.0	~25	1,660	830	~90	~3.0	~28	1,480	740
		140	~2.0	~20	1,530	610	140	~2.0	~22	1,360	540
		210	~1.0	~15	1,400	420	210	~1.0	~17	1,250	380
Austenitic stainless steel (SUS304, 316, 317) 17Cr	JC8050	~90	~3.0	~20	1,400	560	~90	~3.0	~22	1,250	500
		140	~2.0	~15	1,270	380	140	~2.0	~17	1,140	340
		210	~1.0	~10	1,150	230	210	~1.0	~11	1,020	200
Ferritic & martensitic stainless steel (SUS403, 420J2, 430) 13Cr	JC8118	~90	~3.0	~25	1,910	960	~90	~3.0	~28	1,710	860
		140	~2.0	~20	1,660	660	140	~2.0	~22	1,480	590
		210	~1.0	~15	1,400	420	210	~1.0	~17	1,250	380

Note

1. Please adjust cutting conditions according to machine rigidity or work rigidity.
2. In case of chatter occurring, recommended to reduce a_p or rpm and keep feed per tooth.
3. a_p should be reduced when using on low rigidity machine.
4. Use air blow.

In case of slot milling , apply 50% or less feed (V_f) from standard cutting condition table.

SIC-EVO

SSV Type

- Recommended cutting conditions
- Modular head type + MSN carbide shank - Face milling

Material	Grade	Tool dia.(mm)									
		30					32				
		3N					3N				
		ℓ (mm)	ap (mm)	ae (mm)	n (min ⁻¹)	Vf (mm/min)	ℓ (mm)	ap (mm)	ae (mm)	n (min ⁻¹)	Vf (mm/min)
Carbon steel (S50C, S55C) below 250HB	JC8050	~100	~3.5	~30	1,590	1,430	~100	~3.5	~32	1,490	1,340
		150	~2.5	~24	1,380	1,040	150	~2.5	~26	1,290	970
		210	~1.5	~18	1,170	700	210	~1.5	~19	1,090	650
Cast steel (GM190, ICD5) below 285HB	JC8050	~100	~3.5	~30	1,590	1,430	~100	~3.5	~32	1,490	1,340
		150	~2.5	~24	1,380	1,040	150	~2.5	~26	1,290	970
		210	~1.5	~18	1,170	700	210	~1.5	19	1,090	650
Tool & die steel (SKD61, SKD11) below 255HB	JC8050	~100	~3.5	~30	1,590	1,190	~100	~3.5	~32	1,490	1,120
		150	~2.5	~24	1,380	830	150	~2.5	~26	1,290	770
		210	~1.5	~18	1,170	530	210	~1.5	~19	1,090	490
Mold steel (HPM7, PX5, P20) 30-36 HRC	JC8118	~100	~3.5	~30	1,380	1,040	~100	~3.5	~32	1,290	970
		150	~2.5	~24	1,270	760	150	~2.5	~26	1,190	710
		210	~1.5	~18	1,170	530	210	~1.5	~19	1,090	490
Mold steel (NAK80, HPM1, P21) 38-43HRC	JC8118	~100	~2.5	~30	1,170	880	~100	~2.5	~32	1,090	820
		150	~2.0	~24	1,060	640	150	~2.0	~26	990	590
		210	~1.5	~18	950	430	210	~1.5	~19	900	410
Hardened die steel (SKD61, DAC, DHA) 42-52HRC	JC8118	~100	~2.0	~24	950	570	~100	~2.0	~26	900	540
		150	~1.5	~18	850	380	150	~1.5	~19	800	360
		210	~1.0	~12	740	220	210	~1.0	~13	700	210
Grey cast iron (FC250) 160-260HB	JC8118	~100	~5.5	~30	2,120	1,910	~100	~5.5	~32	1,990	1,790
		150	~3.5	~24	1,910	1,430	150	~3.5	~26	1,790	1,340
		210	~1.5	~18	1,700	1,020	210	~1.5	~19	1,590	950
Nodular cast iron (FCD700) 170-300HB	JC8118	~100	~3.5	~30	1,380	1,040	~100	~3.5	~32	1,290	970
		150	~2.5	~24	1,270	760	150	~2.5	~26	1,190	710
		210	~1.5	~18	1,170	530	210	~1.5	~19	1,090	490
Austenitic stainless steel (SUS304, 316, 317) 17Cr	JC8050	~100	~3.5	~24	1,170	700	~100	~3.5	~26	1,090	650
		150	~2.5	~18	1,060	480	150	~2.5	~19	990	450
		210	~1.5	~12	950	290	210	~1.5	~13	900	270
Ferritic & martensitic stainless steel (SUS403, 420J2, 430) 13Cr	JC8118	~100	~3.5	~30	1,590	1,190	~100	~3.5	~32	1,490	1,120
		150	~2.5	~24	1,380	830	150	~2.5	~26	1,290	770
		210	~1.5	~18	1,170	530	210	~1.5	~19	1,090	490

Note

1. Please adjust cutting conditions according to machine rigidity or work rigidity.
2. In case of chatter occurring, recommended to reduce ap or rpm and keep feed per tooth.
3. ap should be reduced when using on low rigidity machine.
4. Use air blow.

In case of slot milling , apply 50% or less feed (Vf) from standard cutting condition table.

SIC-EVO**SSV Type**

■ Recommended cutting conditions

● Modular head type + MSN carbide shank - Face milling

Material	Grade	Tool dia.(mm)									
		35					40				
		3N					4N				
		l (mm)	a_p (mm)	a_e (mm)	n (min^{-1})	V_f (mm/min)	l (mm)	a_p (mm)	a_e (mm)	n (min^{-1})	V_f (mm/min)
Carbon steel (S50C, S55C) below 250HB	JC8050	~100	~3.5	~35	1,360	1,220	~100	~3.5	~40	1,190	1,430
		150	~2.5	~28	1,180	890	150	~2.5	~32	1,030	1,030
		210	~1.5	~21	1,000	600	210	~1.5	~24	880	700
Cast steel (GM190, ICD5) below 285HB	JC8050	~100	~3.5	~35	1,360	1,220	~100	~3.5	~40	1,190	1,430
		150	~2.5	~28	1,180	890	150	~2.5	~32	1,030	1,030
		210	~1.5	~21	1,000	600	210	~1.5	~24	880	700
Tool & die steel (SKD61, SKD11) below 255HB	JC8050	~100	~3.5	~35	1,360	1,020	~100	~3.5	~40	1,190	1,190
		150	~2.5	~28	1,180	710	150	~2.5	~32	1,030	820
		210	~1.5	~21	1,000	450	210	~1.5	~24	880	530
Mold steel (HPM7, PX5, P20) 30-36 HRC	JC8118	~100	~3.5	~35	1,180	890	~100	~3.5	~40	1,030	1,030
		150	~2.5	~28	1,090	650	150	~2.5	~32	950	760
		210	~1.5	~21	1,000	450	210	~1.5	~24	880	530
Mold steel (NAK80, HPM1, P21) 38-43HRC	JC8118	~100	~2.5	~35	1,000	750	~100	~2.5	~40	880	880
		150	~2.0	~28	910	550	150	~2.0	~32	800	640
		210	~1.5	~21	820	370	210	~1.5	~24	720	430
Hardened die steel (SKD61, DAC, DHA) 42-52HRC	JC8118	~100	~2.0	~28	820	490	~100	~2.0	~32	720	580
		150	~1.5	~21	730	330	150	~1.5	~24	640	380
		210	~1.0	~14	640	190	210	~1.0	~16	560	220
Grey cast iron (FC250) 160-260HB	JC8118	~100	~5.5	~35	1,820	1,640	~100	~5.5	~40	1,590	1,910
		150	~3.5	~28	1,640	1,230	150	~3.5	~32	1,430	1,430
		210	~1.5	~21	1,460	880	210	~1.5	~24	1,270	1,020
Nodular cast iron (FCD700) 170-300HB	JC8118	~100	~3.5	~35	1,180	890	~100	~3.5	~40	1,030	1,030
		150	~2.5	~28	1,090	650	150	~2.5	~32	950	760
		210	~1.5	~21	1,000	450	210	~1.5	~24	880	530
Austenitic stainless steel (SUS304, 316, 317) 17Cr	JC8050	~100	~3.5	~28	1,000	600	~100	~3.5	~32	880	700
		150	~2.5	~21	910	410	150	~2.5	~24	800	480
		210	~1.5	~14	820	250	210	~1.5	~16	720	290
Ferritic & martensitic stainless steel (SUS403, 420J2, 430) 13Cr	JC8118	~100	~3.5	~35	1,360	1,020	~100	~3.5	~40	1,190	1,190
		150	~2.5	~28	1,180	710	150	~2.5	~32	1,030	820
		210	~1.5	~21	1,000	450	210	~1.5	~24	880	530

Note

1. Please adjust cutting conditions according to machine rigidity or work rigidity.
2. In case of chatter occurring, recommended to reduce a_p or rpm and keep feed per tooth.
3. a_p should be reduced when using on low rigidity machine.
4. Use air blow.

In case of slot milling , apply 50% or less feed (V_f) from standard cutting condition table.

MIRROR BALL

BNM Type

MIRROR BALL

High Precision Indexable Ball Nose End Mill

C-Body



- Insert radius from accuracy is **below ±0.010 mm** when fixed to the holder.
(accuracy **below ±0.006 mm** in insert alone).

Cat.No.	Stock	Dimensions (mm)									Parts		Inserts	Fig.					
		φDc	R	ℓ ₁	ℓ ₂	L	φD1	θ	θ _k	φDs	Screws	Wrench							
BNMS-060017S-06C	●	6	3	—	17	60	5.5	—	—	6	FSW-2005H	A-06	BNM-060/070...	1					
BNMS-060030T-S10C	●			15	30	80		6°	4°14'	10				2					
BNMM-060035S-06C	●			—	35	92		—	—	6				1					
BNML-060017S-06C	●			17	120														
BNMS-080025S-08C	●	8	4	—	25	90	7.5	—	—	8	FSW-2506H	A-07	BNM-080...; RNM-080...	1					
BNMM-080035S-08C	●				35	92													
BNML-080075S-08C	●				75	140													
BNML-080095S-08C	●				95	160													
BNML-080075T-S12C	●				20	75								132	2°	1°37'	12	2	
BNMS-100030S-10C	●	10	5	—	30	100	9.5	—	—	10	FSW-3007H	A-08	BNM-100/110...; RNM-100...	1					
BNMM-100043S-10C	●				43	140													
BNML-100075S-10C	●				75	140													
BNML-100080S-10C	●				80	220													
BNML-100095S-10C	●				95	160													
BNML-100140S-10C	●				140	220													
BNML-100075T-S12C	●				32.1	75								132	1°30'	0°49'	12	2	
BNMS-120028S-12C	●	12	6	—	28	84	11.5	—	—	12	FSW-3509H	A-10	BNM-120...; RNM-120...	1					
BNMM-120053S-12C	●				53	110													
BNML-120095S-12C	●				95	160													
BNML-120100S-12C	●				100	220													
BNML-120085T-S16C	●				33.8	85									145	2°	1°27'	16	2
BNML-120130S-12C	●				130	200													
BNML-120150S-12C	●				150	220													
BNMS-160033S-16C	●	16	8	—	33	93	15	—	—	16	FSW-4013H	A-15	BNM-160...; GRM-160...; RNM-160...	1					
BNMM-160063T-20C	●				37.5	63									123	4°	2°5'	20	2
BNML-160070S-16C	●				70	140													
BNML-160090S-16C	●				90	160													
BNML-160100S-16C	●				100	220													
BNML-160100T-S20C	●				44.5	100									166	2°	1°15'	20	2
BNML-160110S-16C	●				110	180													
BNML-160150S-16C	●				150	220													
BNMS-200039S-20C	●	20	10	—	39	105	19	—	—	20	FSW-5016H	A-20W	BNM-200...; GRM-200...; RNM-200...	1					
BNMM-200075S-20C	●				75	141													

MIRROR BALL **BNM Type**

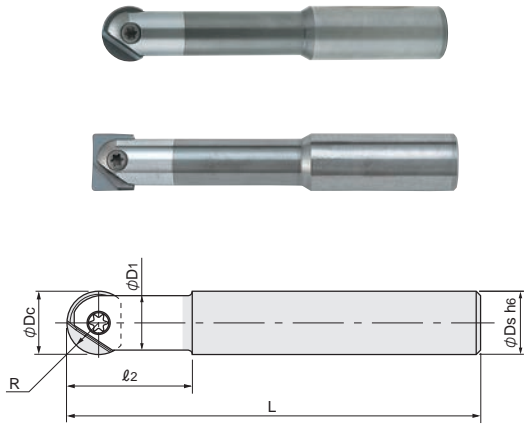

Fig 1

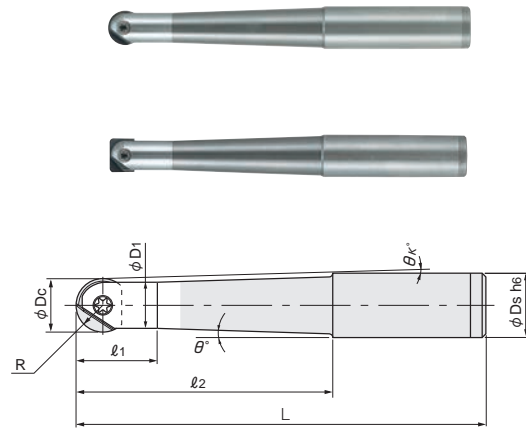

Fig 2

Cat.No.	Stock	Dimensions (mm)									Parts		Inserts	Fig.
		φDc	R	l1	l2	L	φD1	θ	θk	φDs	Screws	Wrench		
BNML-200100S-20C	●	20	10	64.3	100	220	19	2°	1°22'	20	FSW-5016H	A-20W	BNM-200...; RNM-200...	1
BNML-200105S-20C	●				105	180								2
BNML-200115T-S25C	●				115	191								2
BNML-200125S-20C	●				125	200								2
BNML-200170S-20C	●				170	250								2
BNML-200220S-20C	●				220	300								2
BNMM-250090S-25C	●	25	12.5	-	90	166	24	-	-	25	FSW-6020	A-30	BNM-250...; RNM-250...	1
BNML-250100S-25C	●				100	220								
BNML-250140S-25C	●				140	220								
BNML-250170S-25C	●				170	250								
BNMM-300120S-32C	●	30	15	-	120	200	29	-	-	32	FSW-8025S	A-30	BNM-300/320...; RNM-300...	1
BNML-300100S-32C	●				100	220								
BNML-300140S-32C	●				140	220								
BNML-300170S-32C	●				170	250								
BNML-300220S-32C	●				220	300								

Screw	Torque(N.m)
FSW-2005H	0.5
FSW-2506H	0.9
FSW-3007H	1.2
FSW-3509H	2.0
FSW-4013H	3.0
FSW-5016H	4.0
FSW-6020	6.0
FSW-8025S	6.0

MIRROR BALL BNM Type

Modular Head Type

Through coolant hole



- Insert radius from accuracy is **below ±0.010 mm** when fixed to the holder (accuracy **below ±0.006 mm** in insert alone).
- O.D. runout is below 0.015 mm when fixed to MSN carbide shank holder.

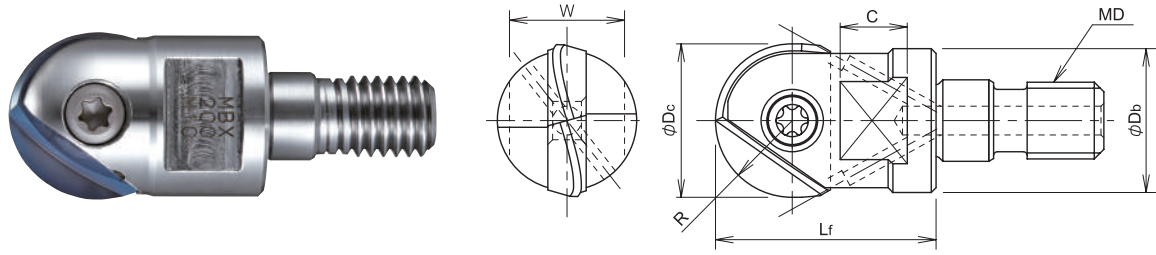

Cat.No.	Stock	Dimensions (mm)							Parts		Inserts
		φDc	R	Lf	φDb	MD	C	W	Screws	Wrench	
MBX-100-M6	●	10	5	18	9.7	M6	6.5	8	FSW-3007H	A-08	BNM-100/110...
MBX-120-M6	●	12	6	20	11.5	M6			FSW-3509H	A-10	BNM-120...
MBX-160-M8	●	16	8	23	15	M8	8	12	FSW-4013H	A-15	BNM-160...; GRM-160...
MBX-200-M10	●	20	10	30	19	M10			14	FSW-5016H	A-20W
MBX-250-M12	●	25	12.5	35	24	M12	10	17	FSW-6020	A-30	BNM-250...; GRM-250...
MBX-300-M16	●	30	15	43	29	M16	12.5	22	FSW-8025S	A-30	BNM-300/320...; GRM-300...

Screw	Torque(N.m)
FSW-3007H	1.2
FSW-3509H	2.0
FSW-4013H	3.0
FSW-5016H	4.0
FSW-6020	6.0
FSW-8025S	6.0

Spanner

	Cat.No.	MD	Torque	width across flat	Thickness	Length
	DS-08	M6	8.0 N.m	8	4	85
	DS-12	M8	16 N.m	12	4	93

MIRROR BALL **BNM Type**

■ **BNM Type - Neutral style geometry (strictly for finishing applications)**

Radius accuracy ± 0.006 mm

● **DH111, JC10000, KT9**

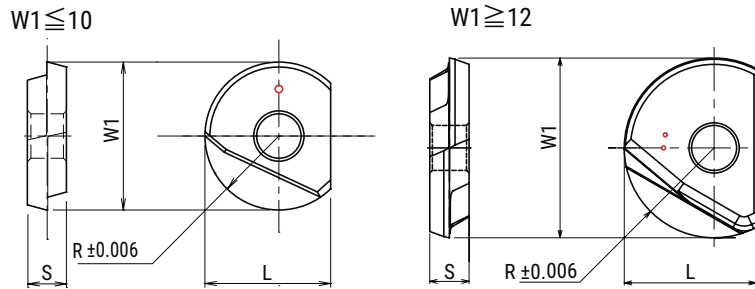
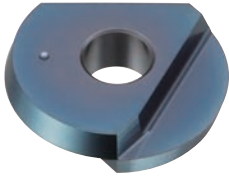

● **CBN**

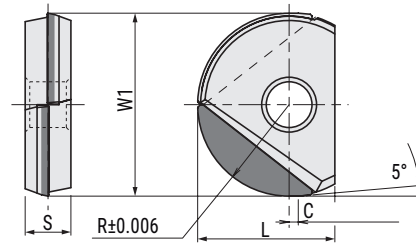
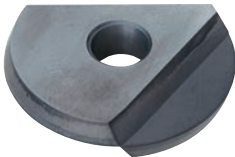

Cat.No.	PVD coating	CBN	DIAMMOND COATING	Uncoated	Dimensions (mm)				
	DH111	JBN245	JC10000	KT9	R	W1	L	C	S
BNM-060	●		●	●	3	6	5	-	2
BNM-070	●		●		3.5	7	5.5	-	2
BNM-080	●		●	●	4	8	7	-	2.4
BNM-100	●		●	●	5	10	8.5	-	2.6
BNM-110			●		5.5	11	9	-	2.6
BNM-120	●		●	●	6	12	10	-	3
BNM-160	●	●	●	●	8	16	12	0.8	4
BNM-200	●	●	●	●	10	20	15	1	5
BNM-250	●	●		●	12.5	25	18.5	1	6
BNM-300	●	●		●	15	30	22.5	1	7
BNM-320	●			●	16	32	23.5	-	7

MIRROR BALL **BNM Type**

■ **BNM-SS Type - Sharp helical geometry**
 (good for finishing and semi finishing general steel , mold steel & stainless steel)

Radius accuracy
 ± 0.006 mm



Fig 1

Fig 2

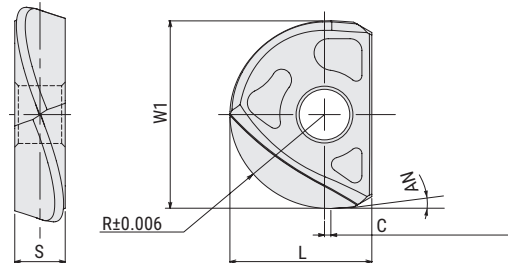
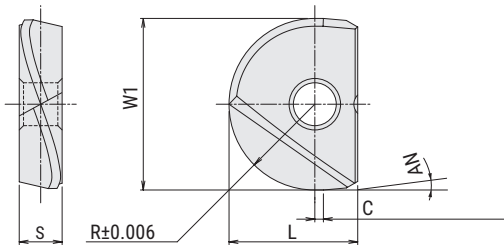

Cat.No.	PVD Coating		Dimensions(mm)						Fig.
	DH108	DS108	R	L	W1	S	C	AN	
BNM-060-SS	●	●	3	5	6	2	—	10°	1
BNM-080-SS	●	●	4	7	8	2.4	0.5	5°	
BNM-100-SS	●	●	5	8.5	10	2.6	1		
BNM-120-SS	●	●	6	10	12	3			
BNM-160-SS	●	●	8	12	16	4			
BNM-200-SS	●	●	10	15	20	5			
BNM-250-SS	●	●	12.5	18.5	25	6		7	2
BNM-300-SS	●	●	15	22.5	30				
BNM-320-SS	●	●	16	23.5	32				

MIRROR BALL **BNM Type**

■ **BNM-TS Type - High Helix geometry**
 (good for semi-finishing & finishing hard materials up to 60HRC)

Radius accuracy
± 0.006 mm

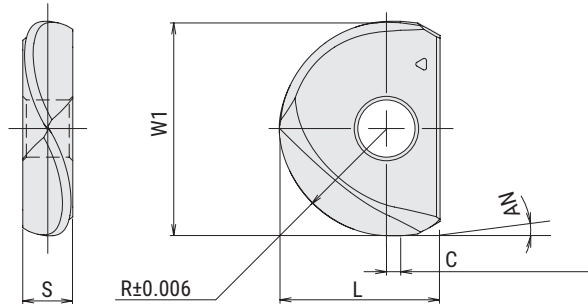
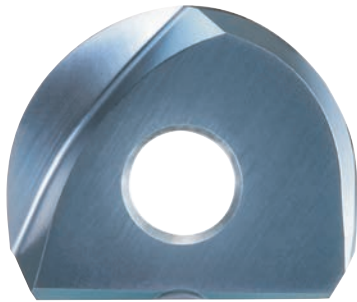

Cat.No.	PVD Coating	Dimensions(mm)					
	DH102	R	W1	L	S	C	AN
BNM-060-TS	●	3	6	5	2	—	10°
BNM-080-TS	●	4	8	7	2.4	0.5	5°
BNM-100-TS	●	5	10	8.5	2.6	1	
BNM-120-TS	●	6	12	10	3	1.5	
BNM-160-TS	●	8	16	12	4		
BNM-200-TS	●	10	20	15	5	2	
BNM-250-TS	●	12.5	25	18.5	6		
BNM-300-TS	●	15	30	22.5	7		
BNM-320-TS	●	16	32	23.5			

MIRROR BALL

BNM Type

■ **BNM-S Type - Sharp helical geometry**
 (good for semi-finishing & finishing non-ferrous metals such as aluminium, copper)

Radius accuracy ± 0.006 mm

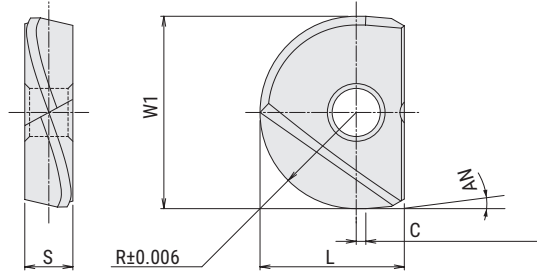

Cat.No.	Uncoated	DLC Coating	Dimensions (mm)					
	FZ05	JC20003	R	L	W1	S	C	AN
BNM-060-S	●	●	3	5	6	2	—	10°
BNM-080-S	●	●	4	7	8	2.4	0.5	5°
BNM-100-S	●	●	5	8.5	10	2.6	1	
BNM-120-S	●	●	6	10	12	3		
BNM-160-S	●	●	8	12	16	4		
BNM-200-S	●	●	10	15	20	5		
BNM-250-S	●	●	12.5	18.5	25	6		
BNM-300-S	●	●	15	22.5	30	7		

■ **BNM-TG type - Helical geometry**
 (good for finishing hard material/weld up to 60 HRC)

Radius accuracy ± 0.006 mm

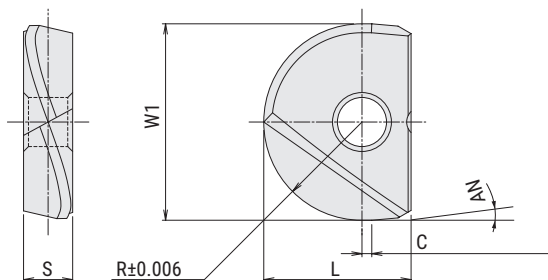
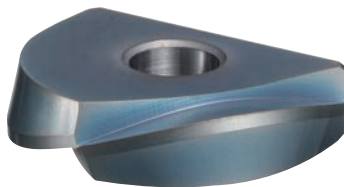

Cat.No.	PVD Coating	Dimensions(mm)					
	DH102	R	L	W1	S	C	AN
BNM-060-TG	●	3	5	6	2	—	10°
BNM-080-TG	●	4	7	8	2.4	0.5	5°
BNM-100-TG	●	5	8.5	10	2.6	1	
BNM-120-TG	●	6	10	12	3	1.5	
BNM-160-TG	●	8	12	16	4		
BNM-200-TG	●	10	15	20	5		
BNM-250-TG	●	12.5	18.5	25	6	2	
BNM-300-TG	●	15	22.5	30	7		
BNM-320-TG	●	16	32	32	7		

MIRROR BALL**BNM Type**■ **Controlled Torque Wrenches (with replaceable blade)**

Wrenches are pre-set to protect screws and bodies against damage during both the tightening and loosening process

● **Controlled Torque Wrenches (with replaceable blade)**

Cat. No.	Torque #	Screw torque	Replacement blade	Applicable inserts
TQC-06	T6	0.5Nm	B-06	BNM○-06... RNM○-06...
TQC-07	T7	0.9Nm	B-07	BNM○-08... RNM○-08...
TQC-08	T8	1.2Nm	B-08	BNM○-10... RNM○-10...
TQC-10	T10	2.0Nm	B-10	BNM○-12... RNM○-12...

● **Replacement blade**

Cat. No.	Torque #	Applicable wrench
B-06	T6	TQC-06
B-07	T7	TQC-07
B-08	T8	TQC-08
B-10	T10	TQC-10

★ **Insert mounting information**

1. Make sure the insert seat on body is carefully cleaned.
2. Make sure insert itself is clean, especially hole and face location.
3. Change insert screw when threads start to wear.
(approximately every 10-15 inserts)
4. Do not over tighten screw, see table for torque specifications.

tool dia.(mm)	Tecommended torque
φD_c	N·m
6	0.5
8	0.9
10	1.2
12	2.0
16	3.0
20	4.0
25	5.0
30	6.0
32	6.0

MIRROR BALL

BNM Type

Grade selection guide

Material	BNM					BNM-S		BNM-SS		BNM-TG	BNM-TS	GRM		
	DH103	DH111	JC10000	KT9	JBN245	FZ05	JC20003	DH108	DS108	DH102	DH102	JC8015	DH102	JBN245
Carbon steel (S50C, S55C) below 250HB	○	◎ ☆						◎				◎	○	
Cast steel (GM190, ICD5) below 285HB	○	◎ ☆						◎				◎	○	
Tool & die steel (SKD61, SKD11) below 255HB	○	◎ ☆						◎				◎	○	
Mold steel (HPM7, PX5, P20) 30-36 HRC	◎	○						◎				○	◎	
Mold steel (NAK80, HPM1, P21) 38-43HRC	◎	○						◎				○	◎	
Hardened die steel (SKD61, DAC, DHA) 42-52HRC	◎	○						◎		○	○	○	◎	
Hardened die steel (SKD11, SLT, DC11) 55-62HRC								○		◎	◎		◎	
HSS (SKH, HAP) 63-70HRC										◎	◎		◎	
Grey cast iron (FC250) 160-260HB	◎	○			★			○		◎	◎	○	◎	★
Nodular cast iron (FCD700) 170-300HB	◎	○			★			○		◎	◎	○	◎	★
Austenitic stainless steel (SUS304, 316, 317) 17Cr	○	◎ ☆						◎	○			◎	○	
Ferritic & martensitic stainless steel (SUS403, 420J2, 430) 13Cr	○	◎ ☆						◎	○			◎	○	
Aluminium alloy (A5052) 160-260HB				◎		◎	◎							
Aluminium alloy (A7075) 160-260HB				◎		◎	◎							
Aluminium alloy Si below 13%				◎		◎	◎							
Copper alloy (C1100)				◎		◎	◎							
Graphite			○				◎							
Titanium alloy (Ti-6Al-4V) 35-43HRC	○	◎ ☆						◎	◎			◎	○	
Heat resistant alloy (INCO718) 35-43HRC	○	◎ ☆						◎	◎			◎	○	

◎: First choice ○: Second choice ☆: Wet cutting ★: High speed cutting

MIRROR BALL**BNM Type**

■ Recommended cutting conditions

Overhang length ℓ/Dc	n (min ⁻¹)	Vf (mm/min)
~3Dc	100%	100%
3Dc~5Dc	70%	70%
5Dc~10Dc	50%	50%

Material	Cat.No.	Grade	Tool dia.(mm)											
			6				8				10			
			ap (mm)	ae (mm)	n (min ⁻¹)	Vf (mm/min)	ap (mm)	ae (mm)	n (min ⁻¹)	Vf (mm/min)	ap (mm)	ae (mm)	n (min ⁻¹)	Vf (mm/min)
Carbon steel (S50C, S55C) below 250HB	BNM BNM-SS	DH111 DH108	0.1	0.1	18,570	5,570	0.1	0.15	13,930	4,180	0.15	0.2	12,730	5,090
Cast steel (GM190, ICD5) below 285HB	BNM BNM-SS	DH111 DH108	0.1	0.1	18,570	5,570	0.1	0.15	13,930	4,180	0.15	0.2	12,730	5,090
Tool & die steel (SKD61, SKD11) below 255HB	BNM BNM-SS	DH111 DH108	0.1	0.1	18,570	5,570	0.1	0.15	13,930	4,180	0.15	0.2	12,730	5,090
Mold steel (HPM7, PX5, P20) 30-36 HRC	BNM BNM-SS	DH111 DH108	0.05	0.1	18,570	5,570	0.05	0.15	13,930	4,180	0.1	0.2	12,730	5,090
Mold steel (NAK80, HPM1, P21) 38-43HRC	BNM BNM-SS	DH111 DH108	0.05	0.1	15,920	3,180	0.05	0.15	11,940	2,390	0.1	0.2	11,140	3,340
Hardened die steel (SKD61, DAC, DHA) 42-52HRC	BNM BNM-SS	DH103 DH108	0.05	0.1	13,260	2,650	0.05	0.15	9,950	1,990	0.1	0.2	9,550	2,870
Hardened die steel (SKD11, SLD, DC11) 55-62HRC	BNM-TG BNM-TS	DH102	0.05	0.1	10,610	2,120	0.05	0.15	7,960	1,590	0.1	0.15	7,960	2,390
HSS (SKH, HAP) 63-70HRC	BNM-TG BNM-TS	DH102	0.05	0.05	7,960	1,590	0.05	0.1	5,970	1,190	0.05	0.1	6,370	1,270
Grey cast iron (FC250) 160-260HB	BNM BNM-TG BNM-TS	DH111 DH102	0.1	0.1	18,570	7,430	0.1	0.15	13,930	5,570	0.15	0.2	12,730	6,370
Nodular cast iron (FCD700) 170-300HB	BNM BNM-TG BNM-TS	DH111 DH102	0.1	0.1	18,570	7,430	0.1	0.15	13,930	5,570	0.15	0.2	12,730	6,370
Austenitic stainless steel (SUS304, 316, 317) 17Cr	BNM BNM-SS	DH111 DH108	0.1	0.1	18,570	5,570	0.1	0.15	13,930	4,180	0.15	0.2	12,730	5,090
Ferritic & martensitic stainless steel (SUS403, 420J2, 430) 13Cr	BNM BNM-SS	DH111 DH108	0.1	0.1	18,570	5,570	0.1	0.15	13,930	4,180	0.15	0.2	12,730	5,090
Aluminium alloy (A5052) 160-260HB	BNM BNM-S	KT9 FZ05 JC20003	0.2	0.1	23,870	9,550	0.2	0.15	17,900	7,160	0.25	0.2	15,920	7,960
Aluminium alloy (A7075) 160-260HB	BNM BNM-S	KT9 FZ05 JC20003	0.2	0.1	23,870	9,550	0.2	0.15	17,900	7,160	0.25	0.2	15,920	7,960
Aluminium alloy Si below 13%	BNM BNM-S	KT9 FZ05 JC20003	0.2	0.1	23,870	9,550	0.2	0.15	17,900	7,160	0.25	0.2	15,920	7,960
Copper alloy (C1100)	BNM BNM-S	KT9 FZ05 JC20003	0.15	0.1	23,870	9,550	0.15	0.15	17,900	7,160	0.2	0.2	15,920	7,960
Graphite	BNM BNM-S	JC10000 JC20003	0.15	0.1	23,870	9,550	0.15	0.15	17,900	7,160	0.2	0.2	15,920	7,960
Titanium alloy (Ti-6Al-4V) 35-43HRC	BNM BNM-SS	DH111 DS108	0.05	0.1	10,610	3,180	0.05	0.15	7,960	2,390	0.1	0.15	9,550	3,820
Heat resistant alloy (INCO718) 35-43HRC	BNM BNM-SS	DH111 DS108	0.05	0.1	7,960	1,590	0.05	0.1	5,970	1,190	0.1	0.1	6,370	1,910

- Note
1. Please adjust cutting conditions according to machine rigidity or work rigidity.
 2. These cutting conditions represent stable machining at length 3 x Dc. please adjust cutting conditions according to overhang length.
 3. In case of chatter occurring, recommended to reduce ap or feed.
 4. Use air blow.

MIRROR BALL BNM Type

■ Recommended cutting conditions

Overhang length ℓ/Dc	n (min ⁻¹)	Vf (mm/min)
~3Dc	100%	100%
3Dc~5Dc	70%	70%
5Dc~10Dc	50%	50%

Material	Cat.No.	Grade	Tool dia.(mm)											
			12				16				20			
			ap (mm)	ae (mm)	n (min ⁻¹)	Vf (mm/min)	ap (mm)	ae (mm)	n (min ⁻¹)	Vf (mm/min)	ap (mm)	ae (mm)	n (min ⁻¹)	Vf (mm/min)
Carbon steel (S50C, S55C) below 250HB	BNM BNM-SS	DH111 DH108	0.15	0.2	10,610	4,240	0.15	0.25	8,950	5,370	0.15	0.3	7,160	5,010
Cast steel (GM190, ICD5) below 285HB	BNM BNM-SS	DH111 DH108	0.15	0.2	10,610	4,240	0.15	0.25	8,950	5,370	0.15	0.3	7,160	5,010
Tool & die steel (SKD61, SKD11) below 255HB	BNM BNM-SS	DH111 DH108	0.15	0.2	10,610	4,240	0.15	0.25	8,950	5,370	0.15	0.3	7,160	5,010
Mold steel (HPM7, PX5, P20) 30-36 HRC	BNM BNM-SS	DH103 DH108	0.1	0.2	10,610	4,240	0.1	0.25	8,950	5,370	0.1	0.3	7,160	5,010
Mold steel (NAK80, HPM1, P21) 38-43HRC	BNM BNM-SS	DH103 DH108	0.1	0.2	9,280	2,780	0.1	0.25	7,960	3,980	0.1	0.3	6,370	3,820
Hardened die steel (SKD61, DAC, DHA) 42-52HRC	BNM BNM-SS	DH103 DH108	0.1	0.2	7,960	2,390	0.1	0.25	6,960	3,480	0.1	0.3	5,570	3,340
Hardened die steel (SKD11, SLD, DC11) 55-62HRC	BNM-TG BNM-TS	DH102	0.1	0.2	6,630	1,990	0.1	0.25	5,970	2,990	0.1	0.3	4,770	2,860
HSS (SKH, HAP) 63-70HRC	BNM-TG BNM-TS	DH102	0.05	0.1	5,310	1,060	0.05	0.1	4,970	1,490	0.05	0.15	3,980	1,190
Grey cast iron (FC250) 160-260HB	BNM BNM-TG BNM-TS	DH103 DH102	0.15	0.2	10,610	5,310	0.15	0.25	8,950	6,270	0.15	0.3	7,160	5,730
Nodular cast iron (FCD700) 170-300HB	BNM BNM-TG BNM-TS	DH103 DH102	0.15	0.2	10,610	5,310	0.15	0.25	8,950	6,270	0.15	0.3	7,160	5,730
Austenitic stainless steel (SUS304, 316, 317) 17Cr	BNM BNM-SS	DH111 DH108	0.15	0.2	10,610	4,240	0.15	0.25	8,950	5,370	0.15	0.3	7,160	5,010
Ferritic & martensitic stainless steel (SUS403, 420J2, 430) 13Cr	BNM BNM-SS	DH111 DH108	0.15	0.2	10,610	4,240	0.15	0.25	8,950	5,370	0.15	0.3	7,160	5,010
Aluminium alloy (A5052) 160-260HB	BNM BNM-S	KT9 FZ05 JC20003	0.25	0.2	13,260	6,630	0.25	0.25	10,940	7,660	0.25	0.3	8,750	7,000
Aluminium alloy (A7075) 160-260HB	BNM BNM-S	KT9 FZ05 JC20003	0.25	0.2	13,260	6,630	0.25	0.25	10,940	7,660	0.25	0.3	8,750	7,000
Aluminium alloy Si below13%	BNM BNM-S	KT9 FZ05 JC20003	0.25	0.2	13,260	6,630	0.25	0.25	10,940	7,660	0.25	0.3	8,750	7,000
Copper alloy (C1100)	BNM BNM-S	KT9 FZ05 JC20003	0.2	0.2	13,260	6,630	0.2	0.25	10,940	7,660	0.2	0.3	8,750	7,000
Graphite	BNM BNM-S	JC10000 JC20003	0.2	0.2	13,260	6,630	0.2	0.25	10,940	7,660	0.2	0.3	8,750	7,000
Titanium alloy (Ti-6Al-4V) 35-43HRC	BNM BNM-SS	DH111 DS108	0.1	0.2	7,960	3,180	0.1	0.25	5,970	2,990	0.1	0.3	4,770	2,860
Heat resistant alloy (INCO718) 35-43HRC	BNM BNM-SS	DH111 DS108	0.1	0.1	5,310	1,590	0.1	0.1	4,970	1,990	0.1	0.15	3,980	1,590

Note

1. Please adjust cutting conditions according to machine rigidity or work rigidity.
2. These cutting conditions represent stable machining at length 3 x Dc. please adjust cutting conditions according to overhang length.
3. In case of chatter occurring, recommended to reduce ap or feed.
4. Use air blow.

MIRROR BALL**BNM Type**

■ Recommended cutting conditions

Overhang length ℓ/Dc	n (min ⁻¹)	Vf (mm/min)
~3Dc	100%	100%
3Dc~5Dc	70%	70%
5Dc~10Dc	50%	50%

Material	Cat.No.	Grade	Tool dia.(mm)											
			25				30				32			
			ap (mm)	ae (mm)	n (min ⁻¹)	Vf (mm/min)	ap (mm)	ae (mm)	n (min ⁻¹)	Vf (mm/min)	ap (mm)	ae (mm)	n (min ⁻¹)	Vf (mm/min)
Carbon steel (S50C, S55C) below 250HB	BNM BNM-SS	DH111 DH108	0.15	0.4	6,370	4,460	0.15	0.5	5,310	3,720	0.15	0.5	4,970	3,480
Cast steel (GM190, ICD5) below 285HB	BNM BNM-SS	DH111 DH108	0.15	0.4	6,370	4,460	0.15	0.5	5,310	3,720	0.15	0.5	4,970	3,480
Tool & die steel (SKD61, SKD11) below 255HB	BNM BNM-SS	DH111 DH108	0.15	0.4	6,370	4,460	0.15	0.5	5,310	3,720	0.15	0.5	4,970	3,480
Mold steel (HPM7, PX5, P20) 30-36 HRC	BNM BNM-SS	DH103 DH108	0.1	0.4	6,370	4,460	0.1	0.5	5,310	3,720	0.1	0.5	4,970	3,480
Mold steel (NAK80, HPM1, P21) 38-43HRC	BNM BNM-SS	DH103 DH108	0.1	0.4	5,730	3,440	0.1	0.5	4,770	2,860	0.1	0.5	4,480	2,690
Hardened die steel (SKD61, DAC, DHA) 42-52HRC	BNM BNM-SS	DH103 DH108	0.1	0.4	5,090	3,050	0.1	0.5	4,240	2,540	0.1	0.5	3,980	2,390
Hardened die steel (SKD11, SLD, DC11) 55-62HRC	BNM-TG BNM-TS	DH102	0.1	0.4	4,460	2,680	0.1	0.5	3,710	2,230	0.1	0.5	3,480	2,090
HSS (SKH, HAP) 63-70HRC	BNM-TG BNM-TS	DH102	0.05	0.2	3,820	1,530	0.05	0.3	3,180	1,270	0.05	0.3	2,980	1,190
Grey cast iron (FC250) 160-260HB	BNM BNM-TG BNM-TS	DH103 DH102	0.15	0.4	6,370	5,100	0.15	0.5	5,310	4,250	0.15	0.5	4,970	3,980
Nodular cast iron (FCD700) 170-300HB	BNM BNM-TG BNM-TS	DH103 DH102	0.15	0.4	6,370	5,100	0.15	0.5	5,310	4,250	0.15	0.5	4,970	3,980
Austenitic stainless steel (SUS304, 316, 317) 17Cr	BNM BNM-SS	DH111 DH108	0.15	0.4	6,370	4,460	0.15	0.5	5,310	3,720	0.15	0.5	4,970	3,480
Ferritic & martensitic stainless steel (SUS403, 420J2, 430) 13Cr	BNM BNM-SS	DH111 DH108	0.15	0.4	6,370	4,460	0.15	0.5	5,310	3,720	0.15	0.5	4,970	3,480
Aluminium alloy (A5052) 160-260HB	BNM BNM-S	KT9 FZ05 JC20003	0.25	0.4	7,640	6,110	0.25	0.5	6,370	5,100	0.25	0.5	5,970	4,780
Aluminium alloy (A7075) 160-260HB	BNM BNM-S	KT9 FZ05 JC20003	0.25	0.4	7,640	6,110	0.25	0.5	6,370	5,100	0.25	0.5	5,970	4,780
Aluminium alloy Si below 13%	BNM BNM-S	KT9 FZ05 JC20003	0.25	0.4	7,640	6,110	0.25	0.5	6,370	5,100	0.25	0.5	5,970	4,780
Copper alloy (C1100)	BNM BNM-S	KT9 FZ05 JC20003	0.2	0.4	7,640	6,110	0.2	0.5	6,370	5,100	0.2	0.5	5,970	4,780
Graphite	BNM BNM-S	JC10000 JC20003	0.2	0.4	7,640	6,110	0.2	0.5	6,370	5,100	0.2	0.5	5,970	4,780
Titanium alloy (Ti-6Al-4V) 35-43HRC	BNM BNM-SS	DH111 DS108	0.1	0.4	4,460	2,680	0.1	0.5	3,710	2,230	0.1	0.5	3,480	2,090
Heat resistant alloy (INCO718) 35-43HRC	BNM BNM-SS	DH111 DS108	0.1	0.2	3,820	1,530	0.1	0.3	3,180	1,270	0.1	0.3	2,980	1,190

Note

1. Please adjust cutting conditions according to machine rigidity or work rigidity.
2. These cutting conditions represent stable machining at length 3 x Dc. please adjust cutting conditions according to overhang length.
3. In case of chatter occurring, recommended to reduce ap or feed.
4. Use air blow.

MIRROR BALL**BNM Type**

■ Recommended cutting conditions

Overhang length ℓ/Dc	n (min ⁻¹)	Vf (mm/min)
~3Dc	100%	100%
3Dc~5Dc	70%	70%
5Dc~10Dc	50%	50%

Material	Cat.No.	Grade	Tool dia.(mm)							
			16				20			
			a _p (mm)	a _e (mm)	n (min ⁻¹)	V _f (mm/min)	a _p (mm)	a _e (mm)	n (min ⁻¹)	V _f (mm/min)
Grey cast iron (FC250) 160-260HB	BNM	JBN245	0.05	0.25	23,870	11,940	0.05	0.3	19,100	11,460
Nodular cast iron (FCD700) 170-300HB	BNM	JBN245	0.05	0.25	19,890	7,960	0.05	0.3	15,920	7,960

Material	Cat.No.	Grade	Tool dia.(mm)							
			25				30			
			a _p (mm)	a _e (mm)	n (min ⁻¹)	V _f (mm/min)	a _p (mm)	a _e (mm)	n (min ⁻¹)	V _f (mm/min)
Grey cast iron (FC250) 160-260HB	BNM	JBN245	0.05	0.4	15,280	9,170	0.05	0.5	12,730	8,910
Nodular cast iron (FCD700) 170-300HB	BNM	JBN245	0.05	0.4	12,730	6,370	0.05	0.5	10,610	6,370

Note

1. These cutting conditions represent on high speed machine.
2. These cutting conditions represent stable machining at length 3 x Dc. please adjust cutting conditions according to overhang length.
3. Use carbide shank holder.
4. For better surface finish , mist coolant is recommended.
5. Plunging is not recommended.
6. Please keep the stock uniform by pre-machining.

MIRROR RADIUS **RNM Type**

MIRROR Radius
High Precision Indexable Radius End Mill

C-Body



● Corner radius accuracy below $\pm 0.010\text{mm}$

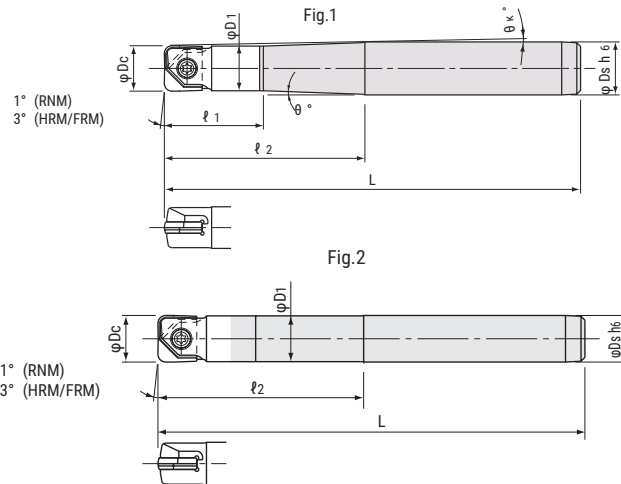

Cat.No.	Stock	Dimensions (mm)							Parts		Inserts	Fig.	
		φD_c	l_1	l_2	L	φD_1	θ°	θ_k	φD_s	Screws			Wrench
RNMS-060015U-S06C	●	6	-	15	60	5.7	-	-	6	FSW-2005H	A-06	RNM-060...; HRM-060...; FRM-060...	2
RNMM-060030U-S06C	●			30	80								
RNMS-080020U-S08C	●	8	-	20	70	7.6	-	-	8	FSW-2506H	A-07	RNM-080...; HRM-080/090...; FRM-080...	1
RNMM-080040U-S08C	●			40	90								
RNMM-080053T-S12C	●			20	53	110			7.8	2°	2°12'	12	
RNML-080075S-S08C	●				75	140			8				
RNMS-100025U-S10C	●	10	-	25	75	9.5	-	-	10	FSW-3007H	A-08	RNM-100...; HRM-100/110...; FRM-100...	2
RNMM-100050U-S10C	●			50	100								
RNMM-100050S-S10C	●			22.5	53	110			9.8	1°	1°7'	12	
RNMM-100053T-S12C	●				75	140			10				
RNMS-120030U-S12C	●	12	-	30	80	11.5	-	-	12	FSW-3509H	A-10	RNM-120/130...; HRM-120/130...; FRM-120...	2
RNMM-120060U-S12C	●			60	110								
RNMM-120053S-S12C	●			53	110	11.8							
RNML-120095S-S12C	●			95	160	15.5							
RNMS-160035U-S16C	●	16	-	35	90	15.5	-	-	16	FSW-4013H	A-15	RNM-160/170...; HRM-160/170...; FRM-160/170...	2
RNMM-160070S-S16C	●			70	140								
RNMM-160090S-S16C	●			90	160	15.8							
RNML-160120S-S16C	●			120	210								
RNML-160150S-S16C	●			150	220								

Screw	Torque (N.m)
FSW-2005H	0.5
FSW-2506H	0.9
FSW-3007H	1.2
FSW-3509H	2.0
FSW-4013H	3.0

MIRROR RADIUS **RNM Type**

MIRROR Radius
High Precision Indexable Radius End Mill

C-Body



● Corner radius accuracy **below ±0.010mm**

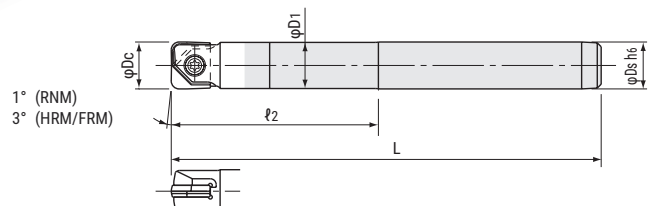

Fig 2

Cat.No.	Stock	Dimensions (mm)					Parts		Inserts	Fig.
		φDc	ℓ2	L	φD1	φDs	Screws	Wrench		
RNMS-200040U-S20C	●	20	40	105	19.8	20	FSW-5016H	A-20W	RNM-200/210...; HRM-200/220...; FRM-200/210...	2
RNMM-200075S-S20C	●		75	141						
RNMM-200105S-S20C	●		105	180						
RNML-200150S-S20C	●		150	220						
RNML-200170S-S20C	●		170	250						
RNMM-250090S-S25C	●	25	90	166	24.8	25	FSW-6020	A-30	RNM-250/260...; FRM-250...	2
RNMM-250140S-S25C	●		140	220						
RNML-250190S-S25C	●		190	260						
RNMM-300106S-S32C	●	30	106	186	29.8	32	FSW-8025S	A-30	RNM-300...; FRM-300...	2
RNMM-320106S-S32C	●	32			31.8					

Screw	Torque (N.m)
FSW-5016H	4.0
FSW-6020	5.0
FSW-8025S	6.0

MIRROR RADIUS MRX Type

- Modular Head Type
- High Precision Indexable Radius End Mill

Through coolant hole



- RNM / Corner radius accuracy **below ±0.010mm**
- HRM / Corner radius accuracy **±0.015 mm**
- FRM / Corner radius accuracy **±0.010 mm**
- O.D. run out / MRX + MSN carbide shank **below ±0.015mm**

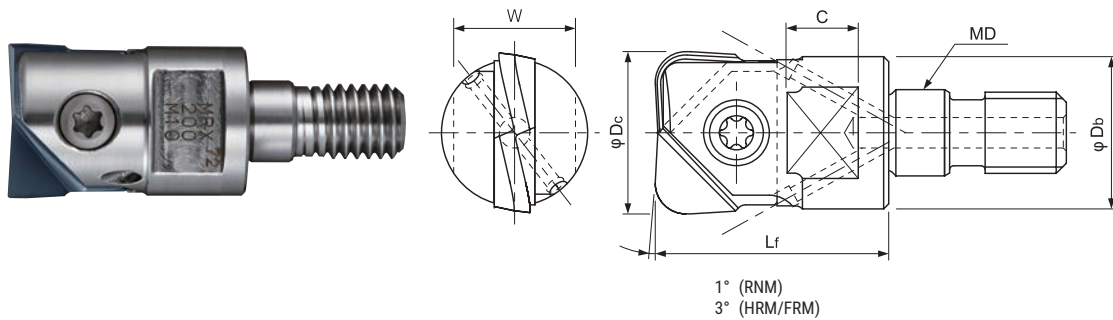

Cat.No.	Stock	Dimensions (mm)					Parts		Inserts	
		φDc	Lf	φDb	MD	C	W	Screws		Wrench
MRX-100-M6	●	10	18	9.7	M6	6.5	8	FSW-3007H	A-08	RNM-100...; HRM-100/110...; FRM-100...
MRX-120-M6	●	12	20	11.5	M6			FSW-3509H	A-10	RNM-120/130...; HRM-120/130...; FRM-120...
MRX-160-M8	●	16	23	15	M8	8	12	FSW-4013H	A-15	RNM-160/170...; HRM-160/170...; FRM-160/170...
MRX-200-M10	●	20	30	18.5	M10			14	FSW-5016H	A-20W
MRX-250-M12	●	25	35	24	M12	10	17	FSW-6020	A-30	RNM-250/260...; FRM-250...
MRX-300-M16	●	30	43	29	M16	12.5	22	FSW-8025S	A-30	RNM-300...; FRM-300...
MRX-320-M16	●	32		30	M16					RNM-320...; FRM-320...

Screw	Torque (N.m)
FSW-3007H	1.2
FSW-3509H	2.0
FSW-4013H	3.0
FSW-5016H	4.0
FSW-6020	5.0
FSW-8025S	6.0

■ Spanner

	Cat.No.	MD	Torque	width across flat	Thickness	Length
	DS-08	M6	8.0 N.m	12	4	85
	DS-12	M8	16 N.m	12	4	93

MIRROR RADIUS **RNM/MRX Type**

● **RNM Type - Neutral geometry** (for finishing applications)

Corner radius accuracy ± 0.010 mm

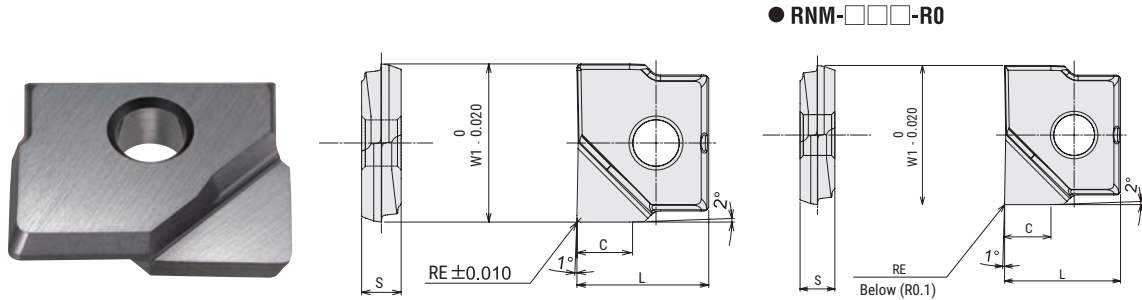

Cat.No	PVD coating		Diamond coating	Uncoated	Dimensions (mm)				
	DH103 (Z05)	JC8015 (Z10~20)	JC10000	KT9 (K10)	RE	L	W1	S	C
RNM-060-R03	●	●			0.3	5	6	2	2
RNM-060-R05	●	●			0.5				
RNM-060-R10	●	●			1				
RNM-080-R03	●	●		●	0.3	7	8	2.4	2.7
RNM-080-R05	●	●	●	●	0.5				
RNM-080-R10	●	●	●	●	1				
RNM-100-R0		●			※	8.5	10	2.6	3.3
RNM-100-R03	●	●		●	0.3				
RNM-100-R05	●	●	●	●	0.5				
RNM-100-R10	●	●	●	●	1				
RNM-100-R15		●		●	1.5				
RNM-100-R20	●	●		●	2				
RNM-120-R0		●			※	10	12	3	4
RNM-120-R03	●	●		●	0.3				
RNM-120-R05	●	●	●	●	0.5				
RNM-120-R10	●	●	●	●	1				
RNM-120-R15	●	●		●	1.5				
RNM-120-R20	●	●		●	2				
RNM-130-R03		●			0.3	10	13	3	4
RNM-130-R05		●			0.5				
RNM-130-R10		●			1				
RNM-130-R20		●			2				
RNM-160-R0		●			※	12	16	4	5.3
RNM-160-R03	●	●		●	0.3				
RNM-160-R05	●	●		●	0.5				
RNM-160-R10	●	●		●	1				
RNM-160-R15	●	●		●	1.5				
RNM-160-R20	●	●		●	2				
RNM-170-R03		●			0.3	12	17	4	5.3
RNM-170-R05		●			0.5				
RNM-170-R10		●			1				
RNM-170-R20		●			2				
RNM-200-R0		●			※	15	20	5	6.7
RNM-200-R03	●	●		●	0.3				
RNM-200-R05	●	●		●	0.5				
RNM-200-R10	●	●		●	1				

MIRROR RADIUS **RNM/MRX Type**

■ **RNM Type - Neutral geometry** (for finishing applications)

Corner radius accuracy ± 0.010 mm

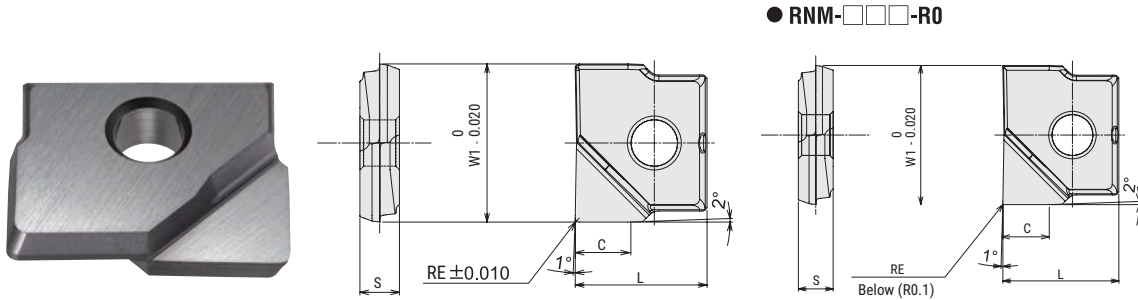

Cat.No	PVD coating		Diamond coating	Uncoated	Dimensions (mm)				
	DH103 (Z05)	JC8015 (Z10~20)	JC10000	KT9 (K10)	RE	L	W1	S	C
RNM-200-R15	●	●		●	1.5	6.7	20	15	5
RNM-200-R20	●	●		●	2				
RNM-200-R30		●			3				
RNM-210-R03		●			0.3	6.7	21	15	5
RNM-210-R05		●			0.5				
RNM-210-R10		●			1				
RNM-210-R20		●			2				
RNM-250-R0		●			※	8.3	25	18.5	6
RNM-250-R03	●	●			0.3				
RNM-250-R05	●	●			0.5				
RNM-250-R10	●	●			1				
RNM-250-R15	●	●			1.5				
RNM-250-R20	●	●			2				
RNM-250-R30		●			3				
RNM-260-R03		●			0.3	8.3	26	18.5	6
RNM-260-R05		●			0.5				
RNM-260-R10		●			1				
RNM-260-R20		●			2				
RNM-300-R03	●	●			0.3	10	30	22.5	7
RNM-300-R05	●	●			0.5				
RNM-300-R10	●	●			1				
RNM-300-R15	●	●			1.5				
RNM-300-R20	●	●			2				
RNM-300-R30		●			3				
RNM-320-R03	●	●			0.3	10.7	32	23.5	7
RNM-320-R05	●	●			0.5				
RNM-320-R10	●	●			1				
RNM-320-R15	●	●			1.5				
RNM-320-R20	●	●			2				
RNM-320-R30		●			3				

MIRROR RADIUS **RNM/MRX Type**

■ **HRM Type - High feed geometry** (from Semi-finishing to finishing)

Corner radius accuracy ± 0.015 mm

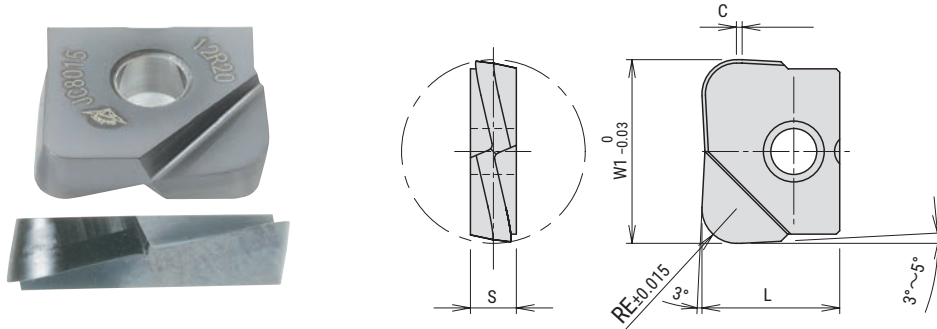

Cat.No.	PVD Coating	Dimensions(mm)				
	JC8015	RE	L	W1	S	C
HRM-060-R05	●	0.5	5	6	2	-
HRM-060-R10	●	1				
HRM-060-R15	●	1.5				
HRM-080-R20	●	2	7	8	2.4	0.3
HRM-090-R20	●			9		
HRM-100-R20	●		8.5	10	2.6	
HRM-110-R20	●			11		
HRM-120-R20	●		10	12	3	
HRM-130-R20	●			13		
HRM-160-R20	●	3	12	16	4	0.5
HRM-160-R30	●			17		
HRM-170-R30	●		2	15	20	
HRM-200-R20	●					
HRM-200-R30	●					
HRM-220-R30	●	3	22			

Mirror Radius Oversized Insert

Recommended to use oversized insert ※ for increasing side clearance to prevent the damage of shank by sticking chips.

(※) **HRM-090-R20, HRM-110-R20, HRM-130-R20, HRM-170-R30, HRM-220-R30**

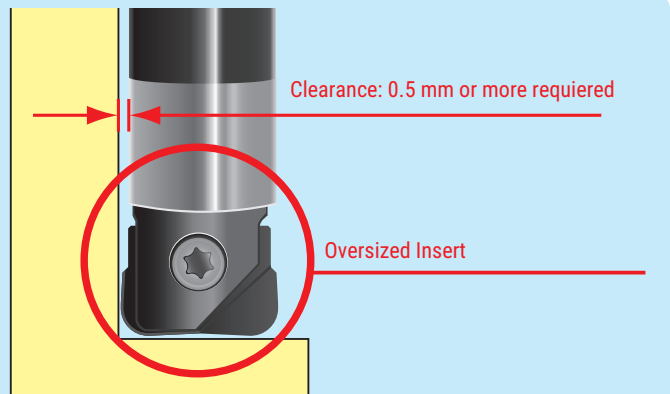

MIRROR RADIUS **RNM/MRX Type**

■ **FRM Type - High feed geometry** (from Semi-finishing to finishing)

Corner radius accuracy ± 0.010 mm

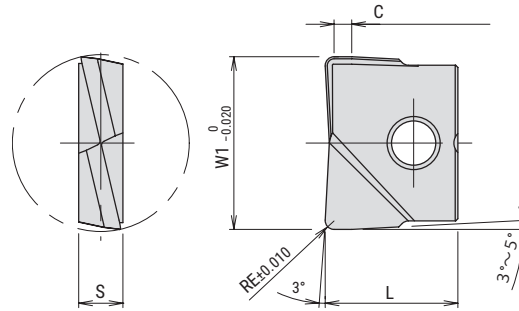
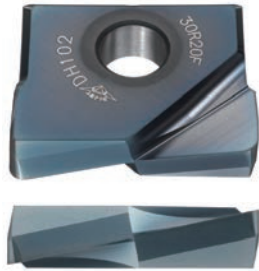

Cat.No.	PVD Coating		Dimensions(mm)					
	DH102	JC8015	RE	L	W1	S	C	
FRM-060-R03	●		0.3	5	6	2	0.8	
FRM-060-R05	●	●	0.5					
FRM-060-R10	●	●	1					
FRM-080-R03	●		0.3	7	8	2.4	1.2	
FRM-080-R05	●	●	0.5					
FRM-080-R10	●	●	1					
FRM-100-R03	●		0.3	8.5	10	2.6	1.5	
FRM-100-R05	●	●	0.5					
FRM-100-R10	●	●	1					
FRM-100-R20	●		2					
FRM-120-R03	●		0.3	10	12	3		2
FRM-120-R05	●	●	0.5					
FRM-120-R10	●	●	1					
FRM-120-R20	●	●	2					
FRM-120-R30	●		3					
FRM-160-R03	●		0.3	12	16	4		
FRM-160-R05	●	●	0.5					
FRM-160-R10	●	●	1					
FRM-160-R15	●		1.5					
FRM-160-R20	●	●	2					
FRM-160-R30	●		3					
FRM-170-R10	●	●	1		17			
FRM-200-R03	●		0.3	15	20	5	2	
FRM-200-R05	●	●	0.5					
FRM-200-R10	●	●	1					
FRM-200-R15	●		1.5					
FRM-200-R20	●	●	2					
FRM-200-R30	●		3					
FRM-210-R10	●	●	1					

Cat.No.	PVD Coating		Dimensions(mm)					
	DH102	JC8015	RE	L	W1	S	C	
FRM-250-R03	●		0.3	18.5	25	6	2.5	
FRM-250-R05	●		0.5					
FRM-250-R10	●	●	1					
FRM-250-R20	●	●	2					
FRM-250-R30	●		3					
FRM-300-R03	●		0.3	22.5	30	7	3	
FRM-300-R05	●		0.5					
FRM-300-R10	●	●	1					
FRM-300-R20	●	●	2					
FRM-300-R30	●		3					
FRM-320-R03	●		0.3	23.5	32			3
FRM-320-R05	●		0.5					
FRM-320-R10	●	●	1					
FRM-320-R20	●	●	2					
FRM-320-R30	●		3					

MIRROR RADIUS**RNM/MRX Type**■ **Grade selection guide**

Material	Cat.No	Grade	RNM				HRM	FRM	
			DH103	JC8015	JC10000	KT9	JC8015	DH102	JC8015
Carbon steel (S50C, S55C) below 250HB	RNM HRM FRM	JC8015		◎			◎		◎
Cast steel (GM190, ICD5) below 285HB	RNM HRM FRM	JC8015		◎			◎		◎
Tool & die steel (SKD61, SKD11) below 255HB	RNM HRM FRM	JC8015		◎			◎		◎
Mold steel (HPM7, PX5, P20) 30-36 HRC	RNM HRM FRM	DH103 JC8015	○	◎			◎		◎
Mold steel (NAK80, HPM1, P21) 38-43HRC	RNM HRM FRM	DH103 JC8015	○	◎			◎		◎
Hardened die steel (SKD61, DAC, DHA) 42-52HRC	HRM FRM	DH102 JC8015		○			○	◎	○
Hardened die steel (SKD11, SLD, DC11) 55-62HRC	FRM	DH102						◎	
HSS (SKH, HAP) 63-70HRC	FRM	DH102	○					◎	
Grey cast iron (FC250) 160-260HB	RNM HRM FRM	DH102 DH103 JC8015	◎	○			○	◎	○
Nodular cast iron (FCD700) 170-300HB	RNM HRM FRM	DH102 DH103 JC8015	◎	○			○	◎	○
Austenitic stainless steel (SUS304, 316, 317) 17Cr	RNM HRM FRM	JC8015	○	◎			◎	○	◎
Ferritic & martensitic stainless steel (SUS403, 420J2, 430) 13Cr	RNM HRM FRM	JC8015	○	◎			◎	○	◎
Aluminium alloy (A5052)	RNM	KT9				◎			
Aluminium alloy (A7075)	RNM	KT9				◎			
Aluminium alloy Si below 13%	RNM	KT9				◎			
Copper alloy (C1100)	RNM	KT9				◎			
Graphite	RNM	JC10000			◎				
Titanium alloy (Ti-6Al-4V) 35-43HRC	HRM FRM	JC8015					◎		◎
Heat resistant alloy (INCO718) 35-43HRC	HRM FRM	JC8015					◎		◎

◎:First choice ○:Second choice ☆:Wet cutting ★:High speed cutting

MIRROR RADIUS**RNM/MRX Type**

■ Recommended cutting conditions

● Side finishing

Overhang length ℓ/Dc	n (min ⁻¹)	Vf (mm/min)
~3Dc	100%	100%
3Dc~5Dc	70%	70%
5Dc~10Dc	50%	50%

Material	Cat.No.	Grade	Tool dia.(mm)											
			6				8				10			
			ap (mm)	ae (mm)	n (min ⁻¹)	Vf (mm/min)	ap (mm)	ae (mm)	n (min ⁻¹)	Vf (mm/min)	ap (mm)	ae (mm)	n (min ⁻¹)	Vf (mm/min)
Carbon steel (S50C, S55C) below 250HB	RNM HRM FRM	JC8015	0.2	0.1	15,920	3,980	0.3	0.1	11940	2990	0.3	0.1	9,550	2,870
Cast steel (GM190, ICD5) below 285HB	RNM HRM FRM	JC8015	0.2	0.1	15,920	3,980	0.3	0.1	11940	2990	0.3	0.1	9,550	2,870
Tool & die steel (SKD61, SKD11) below 255HB	RNM HRM FRM	JC8015	0.2	0.1	15,920	3,980	0.3	0.1	11940	2990	0.3	0.1	9,550	2,870
Mold steel (HPM7, PX5, P20) 30-36 HRC	RNM HRM FRM	DH103 JC8015	0.2	0.1	15,920	3,980	0.3	0.1	11940	2990	0.3	0.1	9,550	2,870
Mold steel (NAK80, HPM1, P21) 38-43HRC	RNM HRM FRM	DH103 JC8015	0.2	0.1	14,850	3,710	0.2	0.1	11140	2790	0.3	0.1	8,910	2,670
Hardened die steel (SKD61, DAC, DHA) 42-52HRC	HRM FRM	DH102 JC8015	0.2	0.1	13,260	1,330	0.2	0.1	9950	1000	0.3	0.1	7,960	800
Hardened die steel (SKD11, SLD, DC11) 55-62HRC	FRM	DH102	0.2	0.1	10,610	1,060	0.2	0.1	7960	800	0.3	0.1	6,370	640
HSS (SKH, HAP) 63-70HRC	FRM	DH102	0.1	0.1	7,960	320	0.1	0.1	5970	240	0.1	0.1	4,770	290
Grey cast iron (FC250) 160-260HB	RNM HRM FRM	DH102 DH103 JC8015	0.2	0.1	18,570	6,500	0.3	0.1	13930	4880	0.3	0.15	11,140	3,900
Nodular cast iron (FCD700) 170-300HB	RNM HRM FRM	DH102 DH103 JC8015	0.2	0.1	18,570	6,500	0.3	0.1	13930	4880	0.3	0.15	11,140	3,900
Austenitic stainless steel (SUS304, 316, 317) 17Cr	RNM HRM FRM	JC8015	0.2	0.1	14,850	4,460	0.3	0.1	11140	3340	0.3	0.1	8,910	2,670
Ferritic & martensitic stainless steel (SUS403, 420J2, 430) 13Cr	RNM HRM FRM	JC8015	0.2	0.1	14,850	4,460	0.3	0.1	11140	3340	0.3	0.1	8,910	2,670
Aluminium alloy (A5052) 160-260HB	RNM	KT9	0.3	0.2	18,570	7,430	0.4	0.2	13930	5570	0.5	0.2	11,140	4,460
Aluminium alloy (A7075) 160-260HB	RNM	KT9	0.3	0.2	18,570	7,430	0.4	0.2	13930	5570	0.5	0.2	11,140	4,460
Aluminium alloy Si below13%	RNM	KT9	0.3	0.2	18,570	7,430	0.4	0.2	13930	5570	0.5	0.2	11,140	4,460
Copper alloy (C1100)	RNM	KT9	0.2	0.15	13,260	5,300	0.25	0.15	9950	3980	0.3	0.15	7,960	3,180
Graphite	RNM	JC10000	0.3	0.2	18,570	7,430	0.4	0.2	13930	5570	0.5	0.2	11,140	4,460
Titanium alloy (Ti-6Al-4V) 35-43HRC	HRM FRM	JC8015	0.2	0.1	5,310	1,060	0.2	0.1	3980	800	0.25	0.1	3,180	760
Heat resistant alloy (INCO718) 35-43HRC	HRM FRM	JC8015	0.2	0.1	4,240	850	0.2	0.1	3180	640	0.25	0.1	2,550	610

- Note
1. Please adjust cutting conditions according to machine rigidity or work rigidity.
 2. These cutting conditions represent stable machining at length 3 x Dc. please adjust cutting conditions according to overhang length.
 3. In case of chatter occurring, recommended to reduce ap or feed.
 4. Use air blow.

MIRROR RADIUS

RNM/MRX Type

■ Recommended cutting conditions

● Side finishing

Overhang length ℓ/Dc	n (min ⁻¹)	Vf (mm/min)
~3Dc	100%	100%
3Dc~5Dc	70%	70%
5Dc~10Dc	50%	50%

Material	Cat.No.	Grade	Tool dia.(mm)											
			12/13				16/17				20/21			
			ap (mm)	ae (mm)	n (min ⁻¹)	Vf (mm/min)	ap (mm)	ae (mm)	n (min ⁻¹)	Vf (mm/min)	ap (mm)	ae (mm)	n (min ⁻¹)	Vf (mm/min)
Carbon steel (S50C, S55C) below 250HB	RNM HRM FRM	JC8015	0.3	0.1	7,960	2,390	0.4	0.1	5,970	2,390	0.5	0.1	4,770	1,910
Cast steel (GM190, ICD5) below 285HB	RNM HRM FRM	JC8015	0.3	0.1	7,960	2,390	0.4	0.1	5,970	2,390	0.5	0.1	4,770	1,910
Tool & die steel (SKD61, SKD11) below 255HB	RNM HRM FRM	JC8015	0.3	0.1	7,960	2,390	0.4	0.1	5,970	2,390	0.5	0.1	4,770	1,910
Mold steel (HPM7, PX5, P20) 30-36 HRC	RNM HRM FRM	DH103 JC8015	0.3	0.1	7,960	2,390	0.4	0.1	5,970	2,390	0.5	0.1	4,770	1,910
Mold steel (NAK80, HPM1, P21) 38-43HRC	RNM HRM FRM	DH103 JC8015	0.3	0.1	7,430	2,230	0.4	0.1	5,570	1,670	0.5	0.1	4,460	1,340
Hardened die steel (SKD61, DAC, DHA) 42-52HRC	HRM FRM	DH102 JC8015	0.3	0.1	6,630	660	0.4	0.1	4,970	750	0.5	0.1	3,980	600
Hardened die steel (SKD11, SL, DC11) 55-62HRC	FRM	DH102	0.3	0.1	5,310	530	0.4	0.1	3,980	600	0.5	0.1	3,180	480
HSS (SKH, HAP) 63-70HRC	FRM	DH102	0.1	0.1	3,980	320	0.2	0.1	2,980	300	0.2	0.1	2,390	240
Grey cast iron (FC250) 160-260HB	RNM HRM FRM	DH102 DH103 JC8015	0.3	0.2	9,280	3,250	0.4	0.2	6,960	3,480	0.5	0.2	5,570	3,340
Nodular cast iron (FCD700) 170-300HB	RNM HRM FRM	DH102 DH103 JC8015	0.3	0.2	9,280	3,250	0.4	0.2	6,960	3,480	0.5	0.2	5,570	3,340
Austenitic stainless steel (SUS304, 316, 317) 17Cr	RNM HRM FRM	JC8015	0.3	0.1	7,430	2,230	0.4	0.1	5,570	2,230	0.5	0.1	4,460	1,780
Ferritic & martensitic stainless steel (SUS403, 420J2, 430) 13Cr	RNM HRM FRM	JC8015	0.3	0.1	7,430	2,230	0.4	0.1	5,570	2,230	0.5	0.1	4,460	1,780
Aluminium alloy (A5052) 160-260HB	RNM	KT9	0.6	0.2	9,280	3,710	0.8	0.2	6,960	3,500	1	0.2	5,570	2,800
Aluminium alloy (A7075) 160-260HB	RNM	KT9	0.6	0.2	9,280	3,710	0.8	0.2	6,960	3,500	1	0.2	5,570	2,800
Aluminium alloy Si below13%	RNM	KT9	0.6	0.2	9,280	3,710	0.8	0.2	6,960	3,500	1	0.2	5,570	2,800
Copper alloy (C1100)	RNM	KT9	0.4	0.15	6,630	2,650	0.5	0.15	4,970	2,500	0.7	0.15	3,980	2,000
Graphite	RNM	JC10000	0.6	0.2	9,280	3,710	0.8	0.2	6,960	3,500	1	0.2	5,570	2,800
Titanium alloy (Ti-6Al-4V) 35-43HRC	HRM FRM	JC8015	0.25	0.1	2,650	640	0.25	0.1	1,990	480	0.3	0.1	1,590	380
Heat resistant alloy (INCO718) 35-43HRC	HRM FRM	JC8015	0.25	0.1	2,120	510	0.25	0.1	1,590	380	0.3	0.1	1,270	300

Note

1. Please adjust cutting conditions according to machine rigidity or work rigidity.
2. These cutting conditions represent stable machining at length 3 x Dc. please adjust cutting conditions according to overhang length.
3. In case of chatter occurring, recommended to reduce ap or feed.
4. Use air blow.

MIRROR RADIUS**RNM/MRX Type**

■ Recommended cutting conditions

● Side finishing

Overhang length ℓ/Dc	n (min ⁻¹)	Vf (mm/min)
~3Dc	100%	100%
3Dc~5Dc	70%	70%
5Dc~10Dc	50%	50%

Material	Cat.No.	Grade	Tool dia.(mm)											
			25/26				30				32			
			ap (mm)	ae (mm)	n (min ⁻¹)	Vf (mm/min)	ap (mm)	ae (mm)	n (min ⁻¹)	Vf (mm/min)	ap (mm)	ae (mm)	n (min ⁻¹)	Vf (mm/min)
Carbon steel (S50C, S55C) below 250HB	RNM HRM FRM	JC8015	0.8	0.1	3,820	1,530	1	0.1	3,180	1,270	1.2	0.1	2,980	1,190
Cast steel (GM190, ICD5) below 285HB	RNM HRM FRM	JC8015	0.8	0.1	3,820	1,530	1	0.1	3,180	1,270	1.2	0.1	2,980	1,190
Tool & die steel (SKD61, SKD11) below 255HB	RNM HRM FRM	JC8015	0.8	0.1	3,820	1,530	1	0.1	3,180	1,270	1.2	0.1	2,980	1,190
Mold steel (HPM7, PX5, P20) 30-36 HRC	RNM HRM FRM	DH103 JC8015	0.8	0.1	3,820	1,530	1	0.1	3,180	1,270	1.2	0.1	2,980	1,190
Mold steel (NAK80, HPM1, P21) 38-43HRC	RNM HRM FRM	DH103 JC8015	0.8	0.1	3,570	1,070	1	0.1	2,970	890	1.2	0.1	2,790	840
Hardened die steel (SKD61, DAC, DHA) 42-52HRC	HRM FRM	DH102 JC8015	0.6	0.1	3,180	480	0.8	0.1	2,650	400	1	0.1	2,490	370
Hardened die steel (SKD11, SLD, DC11) 55-62HRC	FRM	DH102	0.6	0.1	2,550	380	0.8	0.1	2,120	320	1	0.1	1,990	300
HSS (SKH, HAP) 63-70HRC	FRM	DH102	0.3	0.1	1,910	190	0.4	0.1	1,590	160	0.5	0.1	1,490	150
Grey cast iron (FC250) 160-260HB	RNM HRM FRM	DH102 DH103 JC8015	0.8	0.2	4,460	2,680	1	0.2	3,710	2,230	1.2	0.2	3,480	2,090
Nodular cast iron (FCD700) 170-300HB	RNM HRM FRM	DH102 DH103 JC8015	0.8	0.2	4,460	2,680	1	0.2	3,710	2,230	1.2	0.2	3,480	2,090
Austenitic stainless steel (SUS304, 316, 317) 17Cr	RNM HRM FRM	JC8015	0.8	0.1	3,570	1,430	1	0.1	2,970	1,190	1	0.1	2,790	1,120
Ferritic & martensitic stainless steel (SUS403, 420J2, 430) 13Cr	RNM HRM FRM	JC8015	0.8	0.1	3,570	1,430	1	0.1	2,970	1,190	1.2	0.1	2,790	1,120
Aluminium alloy (A5052) 160-260HB	RNM	KT9	1.2	0.2	4,460	2,230	1.6	0.2	3,710	1,860	1.6	0.2	3,480	1,740
Aluminium alloy (A7075) 160-260HB	RNM	KT9	1.2	0.2	4,460	2,230	1.6	0.2	3,710	1,860	1.6	0.2	3,480	1,740
Aluminium alloy Si below13%	RNM	KT9	1.2	0.2	4,460	2,230	1.6	0.2	3,710	1,860	1.6	0.2	3,480	1,740
Copper alloy (C1100)	RNM	KT9	0.8	0.15	3,180	1,590	1	0.15	2,650	1,330	1	0.15	2,490	1,250
Graphite	RNM	JC10000	1.2	0.2	4,460	2,230	1.6	0.2	3,710	1,860	1.6	0.2	3,480	1,740
Titanium alloy (Ti-6Al-4V) 35-43HRC	HRM FRM	JC8015	0.35	0.1	1,270	320	0.4	0.1	1,060	270	0.4	0.1	990	250
Heat resistant alloy (INCO718) 35-43HRC	HRM FRM	JC8015	0.35	0.1	1,020	260	0.4	0.1	850	210	0.4	0.1	800	200

Note

1. Please adjust cutting conditions according to machine rigidity or work rigidity.
2. These cutting conditions represent stable machining at length 3 x Dc. please adjust cutting conditions according to overhang length.
3. In case of chatter occurring, recommended to reduce ap or feed.
4. Use air blow.

MIRROR RADIUS

RNM/MRX Type

- Recommended cutting conditions
- Bottom finishing

Overhang length ℓ/Dc	n (min ⁻¹)	Vf (mm/min)
~3Dc	100%	100%
3Dc~5Dc	70%	70%
5Dc~10Dc	50%	50%

Material	Cat.No.	Grade	Tool dia.(mm)											
			6				8				10			
			ap (mm)	ae (mm)	n (min ⁻¹)	Vf (mm/min)	ap (mm)	ae (mm)	n (min ⁻¹)	Vf (mm/min)	ap (mm)	ae (mm)	n (min ⁻¹)	Vf (mm/min)
Carbon steel (S50C, S55C) below 250HB	RNM HRM FRM	JC8015	0.1	1.0(~3)	13,790	3,450	0.15	1.2(~4)	10,350	3,110	0.15	1.2(~5)	8,280	2,480
Cast steel (GM190, ICD5) below 285HB	RNM HRM FRM	JC8015	0.1	1.0(~3)	13,790	3,450	0.15	1.2(~4)	10,350	3,110	0.15	1.2(~5)	8,280	2,480
Tool & die steel (SKD61, SKD11) below 255HB	RNM HRM FRM	JC8015	0.1	1.0(~3)	13,790	3,450	0.15	1.2(~4)	10,350	3,110	0.15	1.2(~5)	8,280	2,480
Mold steel (HPM7, PX5, P20) 30-36 HRC	RNM HRM FRM	DH103 JC8015	0.1	1.0(~3)	13,790	3,450	0.15	1.2(~4)	10,350	3,110	0.15	1.2(~5)	8,280	2,480
Mold steel (NAK80, HPM1, P21) 38-43HRC	RNM HRM FRM	DH103 JC8015	0.1	1.0(~3)	12,730	3,180	0.15	1.2(~4)	9,550	2,870	0.15	1.2(~5)	7,640	2,290
Hardened die steel (SKD61, DAC, DHA) 42-52HRC	HRM FRM	DH102 JC8015	0.05	1.0(~3)	10,080	1,010	0.06	1.2(~4)	7,560	760	0.08	1.2(~5)	6,050	610
Hardened die steel (SKD11, SLD, DC11) 55-62HRC	FRM	DH102	0.05	1.0(~3)	6,900	690	0.06	1.2(~4)	5,170	520	0.08	1.2(~5)	4,140	410
HSS (SKH, HAP) 63-70HRC	FRM	DH102	0.03	1.0(~2)	5,310	210	0.04	1.2(~3)	3,980	160	0.05	1.2(~4)	3,180	190
Grey cast iron (FC250) 160-260HB	RNM HRM FRM	DH102 DH103 JC8015	0.1	1.0(~3)	15,920	4,780	0.15	1.2(~4)	11,940	4,180	0.15	1.2(~5)	9,550	3,340
Nodular cast iron (FCD700) 170-300HB	RNM HRM FRM	DH102 DH103 JC8015	0.1	1.0(~3)	15,920	4,780	0.15	1.2(~4)	11,940	4,180	0.15	1.2(~5)	9,550	3,340
Austenitic stainless steel (SUS304, 316, 317) 17Cr	RNM HRM FRM	JC8015	0.1	1.0(~3)	12,730	3,180	0.15	1.2(~4)	9,550	2,870	0.15	1.2(~5)	7,640	2,290
Ferritic & martensitic stainless steel (SUS403, 420J2, 430) 13Cr	RNM HRM FRM	JC8015	0.1	1.0(~3)	12,730	3,180	0.15	1.2(~4)	9,550	2,870	0.15	1.2(~5)	7,640	2,290
Aluminium alloy (A5052) 160-260HB	RNM	KT9	0.2	1.0(~3)	15,920	6,370	0.25	1.2(~4)	11,940	4,780	0.25	1.2(~5)	9,550	3,820
Aluminium alloy (A7075) 160-260HB	RNM	KT9	0.2	1.0(~3)	15,920	6,370	0.25	1.2(~4)	11,940	4,780	0.25	1.2(~5)	9,550	3,820
Aluminium alloy Si below 13%	RNM	KT9	0.2	1.0(~3)	15,920	6,370	0.25	1.2(~4)	11,940	4,780	0.25	1.2(~5)	9,550	3,820
Copper alloy (C1100)	RNM	KT9	0.15	1.0(~3)	10,610	3,180	0.2	1.2(~4)	7,960	2,390	0.2	1.2(~5)	6,370	1,910
Graphite	RNM	JC10000	0.2	1.0(~3)	15,920	6,370	0.25	1.2(~4)	11,940	4,780	0.25	1.2(~5)	9,550	3,820
Titanium alloy (Ti-6Al-4V) 35-43HRC	HRM FRM	JC8015	0.1	1.0(~3)	2,920	580	0.15	1.2(~4)	2,190	440	0.15	1.2(~5)	1,750	350
Heat resistant alloy (INCO718) 35-43HRC	HRM FRM	JC8015	0.1	1.0(~3)	2,920	580	0.15	1.2(~5)	2,190	440	0.15	1.2(~5)	1,750	350

Note

1. Please adjust cutting conditions according to machine rigidity or work rigidity.
2. These cutting conditions represent stable machining at length 3 x Dc. please adjust cutting conditions according to overhang length.
3. In case of chatter occurring, recommended to reduce ap or feed.
4. Use air blow.

MIRROR RADIUS**RNM/MRX Type**

■ Recommended cutting conditions

● Bottom finishing

Overhang length ℓ/Dc	n (min ⁻¹)	Vf (mm/min)
~3Dc	100%	100%
3Dc~5Dc	70%	70%
5Dc~10Dc	50%	50%

Material	Cat.No.	Grade	Tool dia.(mm)											
			12/13				16/17				20/21			
			ap (mm)	ae (mm)	n (min ⁻¹)	Vf (mm/min)	ap (mm)	ae (mm)	n (min ⁻¹)	Vf (mm/min)	ap (mm)	ae (mm)	n (min ⁻¹)	Vf (mm/min)
Carbon steel (S50C, S55C) below 250HB	RNM HRM FRM	JC8015	0.15	1.5(~5)	6,900	2,070	0.15	2.0(~9)	5,170	2,070	0.2	2.5(~13)	4,140	1,660
Cast steel (GM190, ICD5) below 285HB	RNM HRM FRM	JC8015	0.15	1.5(~5)	6,900	2,070	0.15	2.0(~9)	5,170	2,070	0.2	2.5(~13)	4,140	1,660
Tool & die steel (SKD61, SKD11) below 255HB	RNM HRM FRM	JC8015	0.15	1.5(~5)	6,900	2,070	0.15	2.0(~9)	5,170	2,070	0.2	2.5(~13)	4,140	1,660
Mold steel (HPM7, PX5, P20) 30-36 HRC	RNM HRM FRM	DH103 JC8015	0.15	1.5(~5)	6,900	2,070	0.15	2.0(~9)	5,170	2,070	0.2	2.5(~13)	4,140	1,660
Mold steel (NAK80, HPM1, P21) 38-43HRC	RNM HRM FRM	DH103 JC8015	0.15	1.5(~5)	6,370	1,910	0.15	2.0(~9)	4,770	1,430	0.2	2.5(~13)	3,820	1,150
Hardened die steel (SKD61, DAC, DHA) 42-52HRC	HRM FRM	DH102 JC8015	0.1	1.5(~5)	5,040	600	0.1	2.0(~9)	3,780	570	0.15	2.5(~13)	3,020	450
Hardened die steel (SKD11, SLD, DC11) 55-62HRC	FRM	DH102	0.1	1.5(~5)	3,450	410	0.1	2.0(~9)	2,590	390	0.15	2.5(~13)	2,070	310
HSS (SKH, HAP) 63-70HRC	FRM	DH102	0.05	1.5(~5)	2,650	210	0.05	2.0(~6)	1,990	200	0.05	2.5(~8)	1,590	160
Grey cast iron (FC250) 160-260HB	RNM HRM FRM	DH102 DH103 JC8015	0.2	1.5(~5)	7,960	3,180	0.2	2.0(~9)	5,970	2,390	0.2	2.5(~13)	4,770	1,910
Nodular cast iron (FCD700) 170-300HB	RNM HRM FRM	DH102 DH103 JC8015	0.2	1.5(~5)	7,960	3,180	0.2	2.0(~9)	5,970	2,390	0.2	2.5(~13)	4,770	1,910
Austenitic stainless steel (SUS304, 316, 317) 17Cr	RNM HRM FRM	JC8015	0.15	1.5(~5)	6,370	1,910	0.15	2.0(~9)	4,770	1,910	0.15	2.5(~13)	3,820	1,530
Ferritic & martensitic stainless steel (SUS403, 420J2, 430) 13Cr	RNM HRM FRM	JC8015	0.15	1.5(~5)	6,370	1,910	0.15	2.0(~9)	4,770	1,910	0.15	2.5(~13)	3,820	1,530
Aluminium alloy (A5052) 160-260HB	RNM	KT9	0.25	1.5(~5)	7,960	3,180	0.25	2.0(~9)	5,970	3,580	0.3	2.5(~13)	4,770	2,860
Aluminium alloy (A7075) 160-260HB	RNM	KT9	0.25	1.5(~5)	7,960	3,180	0.25	2.0(~9)	5,970	3,580	0.3	2.5(~13)	4,770	2,860
Aluminium alloy Si below13%	RNM	KT9	0.25	1.5(~5)	7,960	3,180	0.25	2.0(~9)	5,970	3,580	0.3	2.5(~13)	4,770	2,860
Copper alloy (C1100)	RNM	KT9	0.2	1.5(~5)	5,310	1,590	0.2	2.0(~9)	3,980	1,190	0.25	2.5(~13)	3,180	950
Graphite	RNM	JC10000	0.25	1.5(~5)	7,960	3,180	0.25	2.0(~9)	5,970	3,580	0.3	2.5(~13)	4,770	2,860
Titanium alloy (Ti-6Al-4V) 35-43HRC	HRM FRM	JC8015	0.15	1.5(~5)	1,460	290	0.15	2.0(~9)	1,090	220	0.2	2.5(~13)	880	180
Heat resistant alloy (INCO718) 35-43HRC	HRM FRM	JC8015	0.15	1.5(~5)	1,460	290	0.15	2.0(~9)	1,090	220	0.2	2.5(~13)	880	180

- Note
1. Please adjust cutting conditions according to machine rigidity or work rigidity.
 2. These cutting conditions represent stable machining at length 3 x Dc. please adjust cutting conditions according to overhang length.
 3. In case of chatter occurring, recommended to reduce ap or feed.
 4. Use air blow.

MIRROR RADIUS**RNM/MRX Type**

■ Recommended cutting conditions

● Bottom finishing

Overhang length ℓ/Dc	n (min ⁻¹)	Vf (mm/min)
~3Dc	100%	100%
3Dc~5Dc	70%	70%
5Dc~10Dc	50%	50%

Material	Cat.No.	Grade	Tool dia.(mm)											
			25/26				30				32			
			ap (mm)	ae (mm)	n (min ⁻¹)	Vf (mm/min)	ap (mm)	ae (mm)	n (min ⁻¹)	Vf (mm/min)	ap (mm)	ae (mm)	n (min ⁻¹)	Vf (mm/min)
Carbon steel (S50C, S55C) below 250HB	RNM HRM FRM	JC8015	0.2	4.0(~18)	3,310	1,320	0.2	4.2(~23)	2,760	1,100	0.2	4.2(~25)	2,590	1,040
Cast steel (GM190, ICD5) below 285HB	RNM HRM FRM	JC8015	0.2	4.0(~18)	3,310	1,320	0.2	4.2(~23)	2,760	1,100	0.2	4.2(~25)	2,590	1,040
Tool & die steel (SKD61, SKD11) below 255HB	RNM HRM FRM	JC8015	0.2	4.0(~18)	3,310	1,320	0.2	4.2(~23)	2,760	1,100	0.2	4.2(~25)	2,590	1,040
Mold steel (HPM7, PX5, P20) 30-36 HRC	RNM HRM FRM	DH103 JC8015	0.2	4.0(~18)	3,310	1,320	0.2	4.2(~23)	2,760	1,100	0.2	4.2(~25)	2,590	1,040
Mold steel (NAK80, HPM1, P21) 38-43HRC	RNM HRM FRM	DH103 JC8015	0.2	4.0(~18)	3,060	920	0.2	4.2(~23)	2,550	770	0.2	4.2(~25)	2,390	720
Hardened die steel (SKD61, DAC, DHA) 42-52HRC	HRM FRM	DH102 JC8015	0.15	4.0(~18)	2,420	360	0.15	4.2(~23)	2,020	300	0.15	4.2(~25)	1,890	280
Hardened die steel (SKD11, SLD, DC11) 55-62HRC	FRM	DH102	0.15	4.0(~18)	1,660	250	0.15	4.2(~23)	1,380	210	0.15	4.2(~25)	1,290	190
HSS (SKH, HAP) 63-70HRC	FRM	DH102	0.05	4.0(~10)	1,270	130	0.05	4.2(~12)	1,060	110	0.05	4.2(~13)	990	100
Grey cast iron (FC250) 160-260HB	RNM HRM FRM	DH102 DH103 JC8015	0.2	4.0(~18)	3,820	1,910	0.2	4.2(~23)	3,180	1,590	0.2	4.2(~25)	2,980	1,490
Nodular cast iron (FCD700) 170-300HB	RNM HRM FRM	DH102 DH103 JC8015	0.2	4.0(~18)	3,820	1,910	0.2	4.2(~23)	3,180	1,590	0.2	4.2(~25)	2,980	1,490
Austenitic stainless steel (SUS304, 316, 317) 17Cr	RNM HRM FRM	JC8015	0.15	4.0(~18)	3,060	1,220	0.15	4.2(~23)	2,550	1,020	0.15	4.2(~25)	2,390	960
Ferritic & martensitic stainless steel (SUS403, 420J2, 430) 13Cr	RNM HRM FRM	JC8015	0.15	4.0(~18)	3,060	1,220	0.15	4.2(~23)	2,550	1,020	0.15	4.2(~25)	2,390	960
Aluminium alloy (A5052) 160-260HB	RNM	KT9	0.3	4.0(~18)	3,820	2,290	0.3	4.2(~23)	3,180	1,910	0.3	4.2(~25)	2,980	1,790
Aluminium alloy (A7075) 160-260HB	RNM	KT9	0.3	4.0(~18)	3,820	2,290	0.3	4.2(~23)	3,180	1,910	0.3	4.2(~25)	2,980	1,790
Aluminium alloy Si below13%	RNM	KT9	0.3	4.0(~18)	3,820	2,290	0.3	4.2(~23)	3,180	1,910	0.3	4.2(~25)	2,980	1,790
Copper alloy (C1100)	RNM	KT9	0.25	4.0(~18)	2,550	770	0.25	4.2(~23)	2,120	640	0.25	4.2(~25)	1,990	600
Graphite	RNM	JC10000	0.3	4.0(~18)	3,820	2,290	0.3	4.2(~23)	3,180	1,910	0.3	4.2(~25)	2,980	1,790
Titanium alloy (Ti-6Al-4V) 35-43HRC	HRM FRM	JC8015	0.2	4.0(~18)	700	140	0.2	4.2(~23)	580	120	0.2	4.2(~25)	550	110
Heat resistant alloy (INCO718) 35-43HRC	HRM FRM	JC8015	0.2	4.0(~18)	700	140	0.2	4.2(~23)	580	120	0.2	4.2(~25)	550	110

Note

1. Please adjust cutting conditions according to machine rigidity or work rigidity.
2. These cutting conditions represent stable machining at length 3 x Dc. please adjust cutting conditions according to overhang length.
3. In case of chatter occurring, recommended to reduce ap or feed.
4. Use air blow.

MIRROR RADIUS**RNM/MRX Type**

■ Recommended cutting conditions

● HRM type - High Feed / Semi finishing

Material	Grade	Tool dia.(mm)									
		φ6×R1.5					φ8×R2/φ9×R2				
		ℓ (mm)	a _e (mm)	a _p (mm)	n (min ⁻¹)	V _f (mm/min)	ℓ (mm)	a _e (mm)	a _p (mm)	n (min ⁻¹)	V _f (mm/min)
Carbon steel (S50C, S55C) below 250HB	JC8015	15	2.1	0.20	9,000	8,000	20	2.8	0.40	7,500	8,200
		30	2.1	0.15	9,000	7,200	40	2.8	0.40	7,500	6,750
		-	-	-	-	-	60	2.8	0.25	7,500	6,750
		-	-	-	-	-	80	2.8	0.20	7,500	6,750
Mold steel (HPM7, PX5, NAK80, P20) 30-43HRC	JC8015	15	2.1	0.20	8,500	7,600	20	2.8	0.40	7,100	7,800
		30	2.1	0.15	8,500	6,800	40	2.8	0.40	7,100	6,400
		-	-	-	-	-	60	2.8	0.25	7,100	6,400
		-	-	-	-	-	80	2.8	0.20	7,100	6,400
Tool & die steel (SKD61, SKD11) below 255HB	JC8015	15	2.1	0.20	8,500	7,600	20	2.8	0.40	7,100	7,800
		30	2.1	0.15	8,500	6,800	40	2.8	0.40	7,100	6,400
		-	-	-	-	-	60	2.8	0.25	7,100	6,400
		-	-	-	-	-	80	2.8	0.20	7,100	6,400
Stainless steel (SUS304) below 250HB	JC8015	15	2.1	0.20	8,000	6,400	20	2.8	0.40	6,700	7,300
		30	2.1	0.15	8,000	5,600	40	2.8	0.40	6,700	6,000
		-	-	-	-	-	60	2.8	0.25	6,700	6,000
		-	-	-	-	-	80	2.8	0.20	6,700	6,000
Hardened die steel (SKD61, DAC, DHA) 40-50HRC	JC8015	15	2.1	0.15	6,900	5,500	20	2.8	0.20	6,000	6,600
		30	2.1	0.10	6,900	4,800	40	2.8	0.20	6,000	4,800
		-	-	-	-	-	60	2.8	0.15	6,000	4,800
		-	-	-	-	-	80	2.8	0.10	6,000	4,800
Grey & Nodular cast iron (FC, FCD) below 300HB	JC8015	15	2.1	0.20	7,400	6,600	20	2.8	0.40	6,400	7,600
		30	2.1	0.15	7,400	5,900	40	2.8	0.40	6,400	5,700
		-	-	-	-	-	60	2.8	0.25	6,400	5,700
		-	-	-	-	-	80	2.8	0.20	6,400	5,700
ap adjustment by corner radius ap × ratio	Corner Radius	R0.5	ap×0.65								
		R1	ap×0.80								
		R1.5	ap×1.0								
Reduce ap according to above table with keeping Vf											

Note

1. Please adjust cutting conditions according to machine rigidity or work rigidity.
2. In case of chatter occurring, recommended to reduce ap or Vf.
3. Recommended to reduce the parameters when using on low horse power machine.
4. Use air blow.
5. Reduce ap, n & Vf by 30% in case of cutting material 50-55HRC.
6. Reduce Vf for better surface finish.
7. Use angle 2°30' or below in case of ramping (see right figure).
8. In case of slotting with over 5xDc, reduce Vf or ap appropriately.

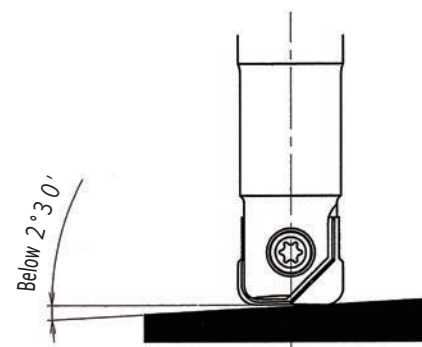

MIRROR RADIUS

RNM/MRX Type

- Recommended cutting conditions
- HRM type - High Feed / Semi finishing

Material	Grade	Tool dia.(mm)									
		φ10×R2/φ11×R2					φ12×R2/φ13×R2				
		φ (mm)	a _e (mm)	a _p (mm)	n (min ⁻¹)	V _f (mm/min)	φ (mm)	a _e (mm)	a _p (mm)	n (min ⁻¹)	V _f (mm/min)
Carbon steel (S50C, S55C) below 250HB	JC8015	25	4.2	0.40	6,000	7,200	30	5.6	0.50	5,000	6,000
		50	4.2	0.40	6,000	6,000	60	5.6	0.40	5,000	5,000
		75	4.2	0.25	6,000	6,000	90	5.6	0.25	5,000	5,000
		100	4.2	0.20	6,000	6,000	120	5.6	0.20	5,000	5,000
Mold steel (HPM7, PX5, NAK80, P20) 30-43HRC	JC8015	25	4.2	0.40	5,700	6,800	30	5.6	0.40	4,700	5,600
		50	4.2	0.40	5,700	5,700	60	5.6	0.40	4,700	4,700
		75	4.2	0.25	5,700	5,700	90	5.6	0.25	4,700	4,700
		100	4.2	0.20	5,700	5,700	120	5.6	0.20	4,700	4,700
Tool & die steel (SKD61, SKD11) below 255HB	JC8015	25	4.2	0.40	5,700	6,800	30	5.6	0.40	4,700	5,600
		50	4.2	0.40	5,700	5,700	60	5.6	0.40	4,700	4,700
		75	4.2	0.25	5,700	5,700	90	5.6	0.25	4,700	4,700
		100	4.2	0.20	5,700	5,700	120	5.6	0.20	4,700	4,700
Stainless steel (SUS304) below 250HB	JC8015	25	4.2	0.40	5,400	6,400	30	5.6	0.40	4,500	5,400
		50	4.2	0.40	5,400	5,400	60	5.6	0.40	4,500	4,500
		75	4.2	0.25	5,400	5,400	90	5.6	0.25	4,500	4,500
		100	4.2	0.20	5,400	5,400	120	5.6	0.20	4,500	4,500
Hardened die steel (SKD61, DAC, DHA) 40-50HRC	JC8015	25	4.2	0.20	4,700	5,600	30	5.6	0.20	4,000	4,800
		50	4.2	0.20	4,700	4,700	60	5.6	0.20	4,000	4,000
		75	4.2	0.15	4,700	4,700	90	5.6	0.15	4,000	4,000
		100	4.2	0.10	4,700	4,700	120	5.6	0.10	4,000	4,000
Grey & Nodular cast iron (FC, FCD) below 300HB	JC8015	25	4.2	0.40	5,100	6,100	30	5.6	0.40	4,200	5,000
		50	4.2	0.40	5,100	5,100	60	5.6	0.40	4,200	4,200
		75	4.2	0.25	5,100	5,100	90	5.6	0.25	4,200	4,200
		100	4.2	0.20	5,100	5,100	120	5.6	0.20	4,200	4,200

Note

1. Please adjust cutting conditions according to machine rigidity or work rigidity.
2. In case of chatter occurring, recommended to reduce a_p or V_f.
3. Recommended to reduce the parameters when using on low horse power machine.
4. Use air blow.
5. Reduce a_p, n & V_f by 30% in case of cutting material 50-55HRC.
6. Reduce V_f for better surface finish.
7. Use angle 2°30' or below in case of ramping (see right figure).
8. In case of slotting with over 5xD_c, reduce V_f or a_p appropriately.

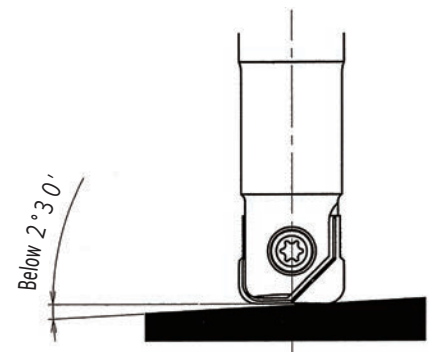

★ **Insert Mounting Information**

1. Make sure the insert seat on body is carefully cleaned.
2. Make sure insert itself is clean, especially the hole and face location.
3. Change insert screw when threads starts to wear.
4. Do not over tighten screw. See table for torque specifications.

Tool dia. (mm)	Torque
φD _c	N·m
6	0.5
8	0.9
10	1.2
12	2.0
16	3.0
20	4.0

MIRROR RADIUS**RNM/MRX Type**

■ Recommended cutting conditions

● HRM type - High Feed / Semi finishing

Material	Grade	Tool dia.(mm)									
		φ16×R3/φ17×R3					φ20×R3/φ22×R3				
		ℓ (mm)	a _e (mm)	a _p (mm)	n (min ⁻¹)	V _f (mm/min)	ℓ (mm)	a _e (mm)	a _p (mm)	n (min ⁻¹)	V _f (mm/min)
Carbon steel (S50C, S55C) below 250HB	JC8015	35	7.0	0.60	3,800	4,500	40	9.8	0.60	3,000	3,600
		80	7.0	0.60	3,800	3,800	100	9.8	0.60	3,000	3,000
		120	7.0	0.40	3,800	3,800	150	9.8	0.40	3,000	3,000
		160	7.0	0.30	3,800	3,800	200	9.8	0.30	3,000	3,000
Mold steel (HPM7, PX5, NAK80, P20) 30-43HRC	JC8015	35	7.0	0.60	3,500	4,200	40	9.8	0.60	2,800	3,300
		80	7.0	0.60	3,500	3,500	100	9.8	0.60	2,800	2,800
		120	7.0	0.40	3,500	3,500	150	9.8	0.40	2,800	2,800
		160	7.0	0.30	3,500	3,500	200	9.8	0.30	2,800	2,800
Tool & die steel (SKD61, SKD11) below 255HB	JC8015	35	7.0	0.60	3,500	4,200	40	9.8	0.60	2,800	3,300
		80	7.0	0.60	3,500	3,500	100	9.8	0.60	2,800	2,800
		120	7.0	0.40	3,500	3,500	150	9.8	0.40	2,800	2,800
		160	7.0	0.30	3,500	3,500	200	9.8	0.30	2,800	2,800
Stainless steel (SUS304) below 250HB	JC8015	35	7.0	0.60	3,400	4,000	40	9.8	0.60	2,700	3,200
		80	7.0	0.60	3,400	3,400	100	9.8	0.60	2,700	2,700
		120	7.0	0.40	3,400	3,400	150	9.8	0.40	2,700	2,700
		160	7.0	0.30	3,400	3,400	200	9.8	0.30	2,700	2,700
Hardened die steel (SKD61, DAC, DHA) 40-50HRC	JC8015	35	7.0	0.30	3,000	3,600	40	9.8	0.30	2,400	2,800
		80	7.0	0.30	3,000	3,000	100	9.8	0.30	2,400	2,400
		120	7.0	0.25	3,000	3,000	150	9.8	0.25	2,400	2,400
		160	7.0	0.20	3,000	3,000	200	9.8	0.20	2,400	2,400
Grey & Nodular cast iron (FC, FCD) below 300HB	JC8015	35	7.0	0.60	3,200	3,800	40	9.8	0.60	2,500	3,000
		80	7.0	0.60	3,200	3,200	100	9.8	0.60	2,500	2,500
		120	7.0	0.40	3,200	3,200	150	9.8	0.40	2,500	2,500
		160	7.0	0.30	3,200	3,200	200	9.8	0.30	2,500	2,500
ap adjustment by corner radius ap × ratio	Corner Radius	R2	ap×0.75				R3	ap×0.75			
		R3	ap×1.0					ap×1.0			
	Reduce ap according to above table with keeping Vf										

Note

1. Please adjust cutting conditions according to machine rigidity or work rigidity.
2. In case of chatter occurring, recommended to reduce ap or Vf.
3. Recommended to reduce the parameters when using on low horse power machine.
4. Use air blow.
5. Reduce ap, n & Vf by 30% in case of cutting material 50-55HRC.
6. Reduce Vf for better surface finish.
7. Use angle 2°30' or below in case of ramping (see right figure).
8. In case of slotting with over 5xDc, reduce Vf or ap appropriately.

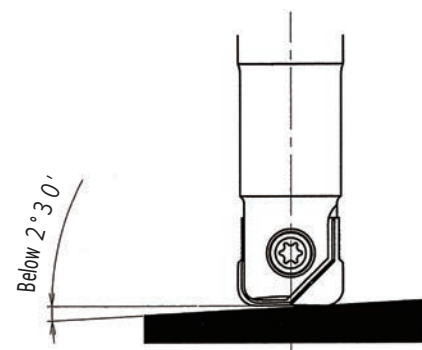

DIEMASTER 5G

High efficient and Multi purpose machining tool for Die and Mold.

FEATURE 1

- Different grade of insert for machining different kind of materials.
- This tool can make all kind of operations, from **semi-finishing** to **finishing**, in any kind of mold.

FEATURE 2

- Economical double-side insert (with 6 cutting edges)
- High accuracy (adopted H-class insert)
- JC8015 for general & mold steel
- DH103 for hardened die steel



ISO	P					M					K				H		
	P01	P10	P20	P30	P40	M01	M10	M20	M30	M40	K01	K10	K20	K30	H01	H10	H20
Applicable range	JC8015					JC8015					JC8015						
	DH103										DH103				DH103		



FEATURE 3

- Many kinds of modular heads are available with combination of carbide shanks.
- Through coolant holes in all bodies give longer tool life and safe operations in cavities.



DIEMASTER 5G

MXF/XFG Type

■ **Facemill Type**

Through coolant hole

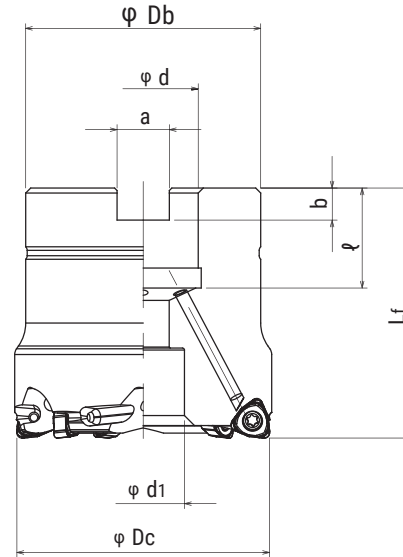

Cat.No.	Stock	No. of inserts	Dimensions (mm)								Arbor set bolt	Weight (kg)	Inserts
			φDc	Lf	φDb	φd	φd1	a	b	ℓ			
XFG-6052R-22	●	6	52	50	47	22	16.5	10.4	6.3	20	M10	0.56	WNHU04T310ZER
XFG-7066R-27	●	7	66	50	48	27	20.0	12.4	7	22	M12×1.75×30★	0.39	

Screw	Torque(N.m)	Wrench
TSW-2567H	1.1	A-08

DIEMASTER 5G **MXF/XFG Type**

■ **Modular Head Type**

Through coolant hole

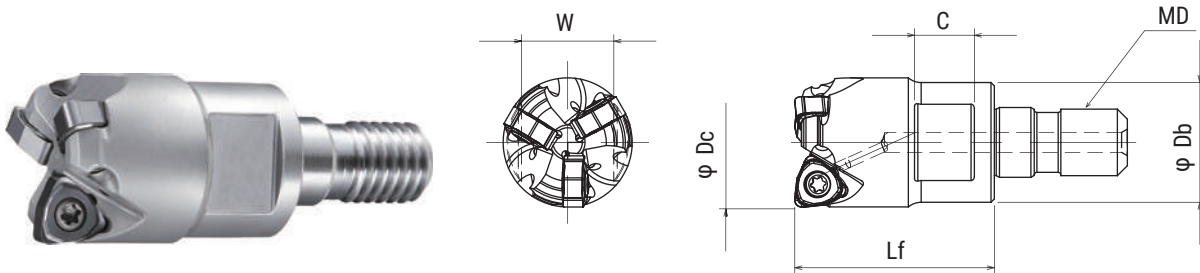

Cat.No.	Stock	No. of inserts	Dimensions (mm)						Inserts
			ϕD_c	Lf	ϕD_b	MD	C	W	
MXF-2016-M8	●	2	16	23	14	M8	8	12	WNHU04T310ZER
MXF-3020-M10	●	3	20	30	18	M10	9	14	
MXF-4025-M12	●	4	25	35	22	M12	11	19	
MXF-5035-M16	●	5	35	43	29	M16	12	22	
MXF-6042-M16	●	6	42	43	32	M16	14	26	

Screw	Torque(N.m)	Wrench
TSW-2567H	1.1	A-08

■ **Insert**

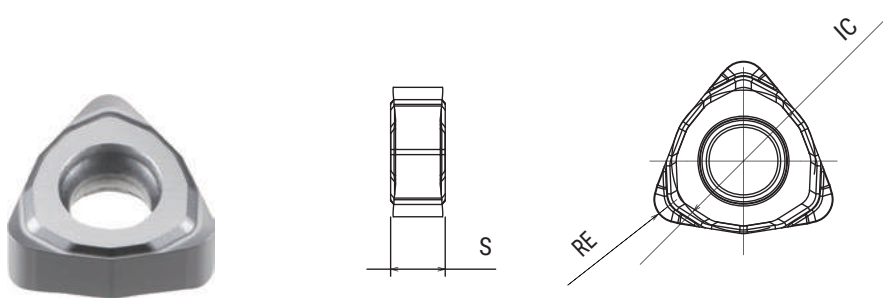

Cat.No.	Tolerance	PVD coated		Dimensions (mm)		
		DH103	JC8015	RE	IC	S
WNHU04T310ZER	H	●	●	1.0	6.35	3.33

Note: 10 inserts per case.

DIEMASTER 5G

MXF/XFG Type

● Attention

⚠ Attention to mounting head and MSN/ MGN shank arbor.

■ Tightening procedure

① Cleaning

Remove dirt and chips with air from the connecting thread and face of modular head and MSN/MGN shank arbor

② Initial Tightening

Tighten by hand until the head and the shank arbor faces touch.

③ Final Tightening

Tighten slowly with torque control spanner wrench or DIJET DS type spanner wrench and confirm that there is no gap.

Attention: Final tightening without initial tightening cause connecting thread damage.

⚠ NOTE

- Note: 1. Please gently apply pressure on wrench.
- 2. Please confirm that there is no gap between MSN/MGN shank arbor and modular

Thread	Tightening torque	Spanner size W (mm)
M8	16N · m	12 ☆
M10	16N · m	14, 15
M12	20N · m	17, 19
M16	25N · m	22, 26

- Note: 1. Modular heads are supplied without spanner wrench.
- 2. In case of choosing torque control spanner wrench, confirm that the wrench size is match to the dimensions W & C of each modular head. (There are some cases that modifying the thickness of spanner wrench is necessary)
- 3. ☆ mark shows: DIJET have a stock of DS-8 and 12 type spanner wrenches.

⚠ Selection of "MSN Carbide shank arbor"

In case of using modular head over $\varphi 16\text{mm}$, please select **MSN carbide shank arbor that diameter ($\varphi D1$) is 1mm or more smaller than modular head (φDc).**

A wrong selection causes damage to the carbide shank.

$$\varphi Dc - \varphi D1 \geq 1\text{mm}$$

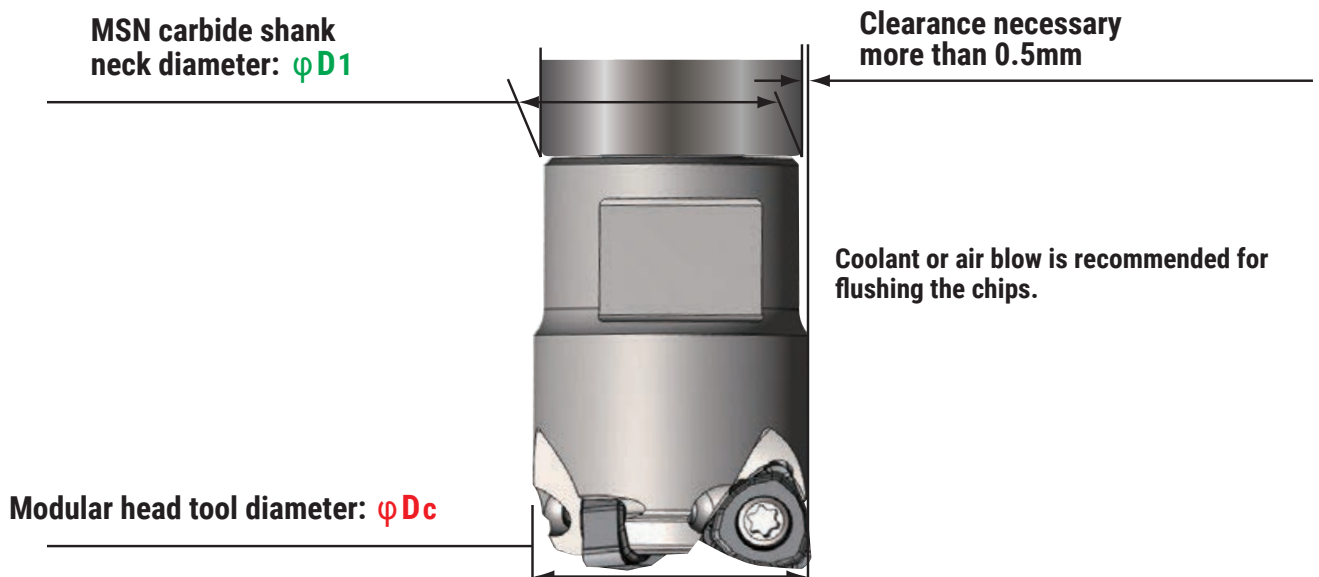

⚠ Caution for the mounting to shrink fit holder.

When you use a carbide shank and a modular head on the shrink fit holder, please shrink fit the only the carbide shank without modular head. **Please mount a modular head after cooling off.**

Note: In case of shrink fit MSN shank + modular head together, it will be difficult to loose due to heat desipation.

DIEMASTER 5G

MXF/XFG Type

Attention for profile milling

Ramping

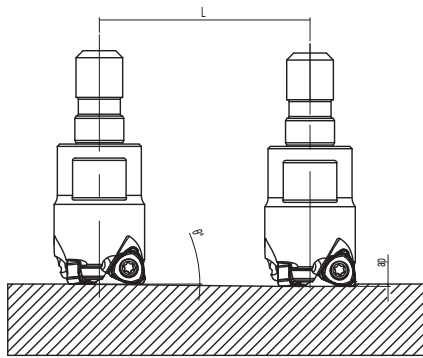

Helical interpolation

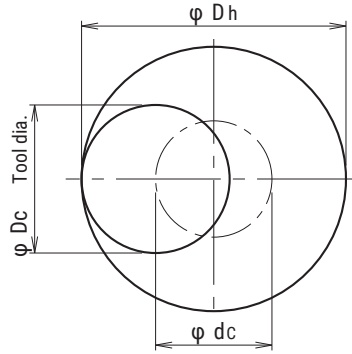

● **Calculation of tool pass dia.**

$$\varphi dc = \varphi Dh - \varphi Dc$$

Tool pass dia. Bore dia. Tool dia.

- Depth of cut per one circuit should not exceed max. depth of cut a_p
- Down cutting is recommended, so tool pass rotation should be counterclockwise.
- To obtain a flat bottom surface when helical milling, it requires to remove "the uncut part" in the center of work materials at final pass.

- ⊙ In case of ramping and helical interpolation, apply 80% or less feed speed from standard cutting condition table.
- ⊙ In case of helical interpolation, recommend wet cutting by coolant through the tool.

Cat. No.	Tool dia. (mm)	Max. depth of cut (mm)	Ramping		Helical interpolation			
			Max. ramping angle θ°	Total cutting length at Max. a_p	Through hole Min. bore dia. Dh min (mm)	Through hole Max. bore dia. Dh max (mm)	Flat bottom Max. bore dia. Dh min (mm)	
MXF-2016-M8	16	0.5	0.4	72	28.2	31	29.6	
MXF-3020-M10	20	0.5	0.3	95	36.2	39	37.6	
MXF-4025-M12	25	0.5	0.2	143	46.2	49	47.6	
MXF-5035-M16	35	0.5	0.15	191	66.2	69	67.6	
MXF-6042-M16	42	0.5	0.1	286	80.2	83	81.6	
XFG-6052R-22	52	0.5	0.1	286	100.2	103	101.6	
XFG-7066R-27	66	0.5	Ramping & helical interpolation is not recommended.					

※ Drilling is not recommended.

DIEMASTER 5G**MXF/XFG Type**

■ Recommended cutting conditions

■ Side wall finishing

Material	Grade	Tool dia.(mm)							
		16				20			
		2N				3N			
		a_p (mm)	a_e (mm)	n (min^{-1})	V_f (mm/min)	a_p (mm)	a_e (mm)	n (min^{-1})	V_f (mm/min)
Carbon steel (S50C, S55C) below 250HB	JC8015	0.3	0.1	5,970	2,390	0.3	0.1	4,770	2,860
Cast steel (GM190, ICD5) below 285HB	JC8015	0.3	0.1	5,970	2,390	0.3	0.1	4,770	2,860
Tool & die steel (SKD61, SKD11) below 255HB	JC8015	0.3	0.1	5,970	2,390	0.3	0.1	4,770	2,860
Mold steel (HPM7, PX5, P20) 30-36 HRC	DH103 JC8015	0.3	0.1	5,970	2,390	0.3	0.1	4,770	2,860
Mold steel (NAK80, HPM1, P21) 38-43HRC	DH103 JC8015	0.3	0.1	5,570	1,670	0.3	0.1	4,460	2,010
Hardened die steel (SKD61, DAC, DHA) 42-52HRC	DH103 JC8015	0.3	0.1	4,970	750	0.3	0.1	3,980	900
Grey cast iron (FC250) 160-260HB	DH103 JC8015	0.3	0.2	6,960	3,480	0.3	0.2	5,570	4,180
Nodular cast iron (FCD700) 170-300HB	DH103 JC8015	0.3	0.2	6,960	3,480	0.3	0.2	5,570	4,180
Austenitic stainless steel (SUS304, 316, 317) 17Cr	JC8015	0.3	0.1	5,570	2,230	0.3	0.1	4,460	2,680
Ferritic & martensitic stainless steel (SUS403, 420J2, 430) 13Cr	JC8015	0.3	0.1	5,570	2,230	0.3	0.1	4,460	2,680
Titanium alloy (Ti-6Al-4V) 35-43HRC	JC8015	0.25	0.1	1,990	480	0.25	0.1	1,590	570
Heat resistant alloy (INCO718) 35-43HRC	JC8015	0.25	0.1	1,590	380	0.25	0.1	1,270	460

Note

1. Please adjust cutting conditions according to machine rigidity or work rigidity.
2. The above cutting conditions are for a overhung length of 3Dc.
Adjust the rotation speed n (min^{-1}) and feed rate V_f (mm/min) according to the protrusion length
3. If chattering occurs, reduce the depth of cut to a shallower depth than the above values or lower the feed rate.
4. Remove chips by air blow. Be especially careful when machining cavities with a vertical MC.
5. When using a steel shank, reduce the rotation speed n (min^{-1}) and feed rate V_f (mm/min) to 80% of the above conditions.

DIEMASTER 5G**MXF/XFG Type**

■ Recommended cutting conditions

■ Side wall finishing

Material	Grade	Tool dia.(mm)							
		25				35			
		4N				5N			
		a_p (mm)	a_e (mm)	n (min^{-1})	V_f (mm/min)	a_p (mm)	a_e (mm)	n (min^{-1})	V_f (mm/min)
Carbon steel (S50C, S55C) below 250HB	JC8015	0.3	0.1	3,820	3,060	0.3	0.1	2,730	2,730
Cast steel (GM190, JCD5) below 285HB	JC8015	0.3	0.1	3,820	3,060	0.3	0.1	2,730	2,730
Tool & die steel (SKD61, SKD11) below 255HB	JC8015	0.3	0.1	3,820	3,060	0.3	0.1	2,730	2,730
Mold steel (HPM7, PX5, P20) 30-36 HRC	DH103 JC8015	0.3	0.1	3,820	3,060	0.3	0.1	2,730	2,730
Mold steel (NAK80, HPM1, P21) 38-43HRC	DH103 JC8015	0.3	0.1	3,570	2,140	0.3	0.1	2,550	1,910
Hardened die steel (SKD61, DAC, DHA) 42-52HRC	DH103 JC8015	0.3	0.1	3,180	950	0.3	0.1	2,270	850
Grey cast iron (FC250) 160-260HB	DH103 JC8015	0.3	0.2	4,460	5,350	0.3	0.2	3,180	4,770
Nodular cast iron (FCD700) 170-300HB	DH103 JC8015	0.3	0.2	4,460	5,350	0.3	0.2	3,180	4,770
Austenitic stainless steel (SUS304, 316, 317) 17Cr	JC8015	0.3	0.1	3,570	2,860	0.3	0.1	2,550	2,550
Ferritic & martensitic stainless steel (SUS403, 420J2, 430) 13Cr	JC8015	0.3	0.1	3,570	2,860	0.3	0.1	2,550	2,550
Titanium alloy (Ti-6Al-4V) 35-43HRC	JC8015	0.3	0.1	1,270	640	0.3	0.1	910	570
Heat resistant alloy (INCO718) 35-43HRC	JC8015	0.3	0.1	1,020	510	0.3	0.1	730	460

Note

1. Please adjust cutting conditions according to machine rigidity or work rigidity.
2. The above cutting conditions are for a overhung length of 3Dc.
Adjust the rotation speed n (min^{-1}) and feed rate V_f (mm/min) according to the protrusion length
3. If chattering occurs, reduce the depth of cut to a shallower depth than the above values or lower the feed rate.
4. Remove chips by air blow. Be especially careful when machining cavities with a vertical MC.
5. When using a steel shank, reduce the rotation speed n (min^{-1}) and feed rate V_f (mm/min) to 80% of the above conditions.

DIEMASTER 5G**MXF/XFG Type**

■ Recommended cutting conditions

■ Side wall finishing

Material	Grade	Tool dia.(mm)							
		42				52			
		6N				6N			
		a_p (mm)	a_e (mm)	n (min ⁻¹)	V_f (mm/min)	a_p (mm)	a_e (mm)	n (min ⁻¹)	V_f (mm/min)
Carbon steel (S50C, S55C) below 250HB	JC8015	0.3	0.1	2,270	2,720	0.3	0.1	1,840	2,210
Cast steel (GM190, ICD5) below 285HB	JC8015	0.3	0.1	2,270	2,720	0.3	0.1	1,840	2,210
Tool & die steel (SKD61, SKD11) below 255HB	JC8015	0.3	0.1	2,270	2,720	0.3	0.1	1,840	2,210
Mold steel (HPM7, PX5, P20) 30-36 HRC	DH103 JC8015	0.3	0.1	2,270	2,720	0.3	0.1	1,840	2,210
Mold steel (NAK80, HPM1, P21) 38-43HRC	DH103 JC8015	0.3	0.1	2,120	1,910	0.3	0.1	1,710	1,540
Hardened die steel (SKD61, DAC, DHA) 42-52HRC	DH103 JC8015	0.3	0.1	1,890	850	0.3	0.1	1,530	690
Grey cast iron (FC250) 160-260HB	DH103 JC8015	0.3	0.2	2,650	4,770	0.3	0.2	2,140	3,850
Nodular cast iron (FCD700) 170-300HB	DH103 JC8015	0.3	0.2	2,650	4,770	0.3	0.2	2,140	3,850
Austenitic stainless steel (SUS304, 316, 317) 17Cr	JC8015	0.3	0.1	2,120	2,540	0.3	0.1	1,710	2,050
Ferritic & martensitic stainless steel (SUS403, 420J2, 430) 13Cr	JC8015	0.3	0.1	2,120	2,540	0.3	0.1	1,710	2,050
Titanium alloy (Ti-6Al-4V) 35-43HRC	JC8015	0.3	0.1	760	570	0.3	0.1	610	460
Heat resistant alloy (INCO718) 35-43HRC	JC8015	0.3	0.1	610	460	0.3	0.1	490	370

Note

1. Please adjust cutting conditions according to machine rigidity or work rigidity.
2. The above cutting conditions are for a overhung length of 3Dc.
Adjust the rotation speed n (min⁻¹) and feed rate V_f (mm/min) according to the protrusion length
3. If chattering occurs, reduce the depth of cut to a shallower depth than the above values or lower the feed rate.
4. Remove chips by air blow. Be especially careful when machining cavities with a vertical MC.
5. When using a steel shank, reduce the rotation speed n (min⁻¹) and feed rate V_f (mm/min) to 80% of the above conditions.

DIEMASTER 5G**MXF/XFG Type**

■ Recommended cutting conditions

■ Side wall finishing

Material	Grade	Tool dia.(mm)			
		66			
		7N			
		a_p (mm)	a_e (mm)	n (min ⁻¹)	V_f (mm/min)
Carbon steel (S50C, S55C) below 250HB	JC8015	0.3	0.1	1,450	2,030
Cast steel (GM190, ICD5) below 285HB	JC8015	0.3	0.1	1,450	2,030
Tool & die steel (SKD61, SKD11) below 255HB	JC8015	0.3	0.1	1,450	2,030
Mold steel (HPM7, PX5, P20) 30-36 HRC	DH103 JC8015	0.3	0.1	1,450	2,030
Mold steel (NAK80, HPM1, P21) 38-43HRC	DH103 JC8015	0.3	0.1	1,350	1,420
Hardened die steel (SKD61, DAC, DHA) 42-52HRC	DH103 JC8015	0.3	0.1	1,210	640
Grey cast iron (FC250) 160-260HB	DH103 JC8015	0.3	0.2	1,690	3,550
Nodular cast iron (FCD700) 170-300HB	DH103 JC8015	0.3	0.2	1,690	3,550
Austenitic stainless steel (SUS304, 316, 317) 17Cr	JC8015	0.3	0.1	1,350	1,890
Ferritic & martensitic stainless steel (SUS403, 420J2, 430) 13Cr	JC8015	0.3	0.1	1,350	1,890
Titanium alloy (Ti-6Al-4V) 35-43HRC	JC8015	0.3	0.1	480	420
Heat resistant alloy (INCO718) 35-43HRC	JC8015	0.3	0.1	390	340

Note

1. Please adjust cutting conditions according to machine rigidity or work rigidity.
2. The above cutting conditions are for a overhung length of 3Dc.
Adjust the rotation speed n (min⁻¹) and feed rate V_f (mm/min) according to the protrusion length
3. If chattering occurs, reduce the depth of cut to a shallower depth than the above values or lower the feed rate.
4. Remove chips by air blow. Be especially careful when machining cavities with a vertical MC.
5. When using a steel shank, reduce the rotation speed n (min⁻¹) and feed rate V_f (mm/min) to 80% of the above conditions.

DIEMASTER 5G**MXF/XFG Type**

■ Recommended cutting conditions

■ Bottom finishing

Material	Grade	Tool dia.(mm)							
		16				20			
		2N				3N			
		a_p (mm)	a_e (mm)	n (min ⁻¹)	V_f (mm/min)	a_p (mm)	a_e (mm)	n (min ⁻¹)	V_f (mm/min)
Carbon steel (S50C, S55C) below 250HB	JC8015	0.15	2.0(~9)	5170	2070	0.2	2.5(~13)	4140	2480
Cast steel (GM190, ICD5) below 285HB	JC8015	0.15	2.0(~9)	5170	2070	0.2	2.5(~13)	4140	2480
Tool & die steel (SKD61, SKD11) below 255HB	JC8015	0.15	2.0(~9)	5170	2070	0.2	2.5(~13)	4140	2480
Mold steel (HPM7, PX5, P20) 30-36 HRC	DH103 JC8015	0.15	2.0(~9)	5170	2070	0.2	2.5(~13)	4140	2480
Mold steel (NAK80, HPM1, P21) 38-43HRC	DH103 JC8015	0.15	2.0(~9)	4770	1430	0.2	2.5(~13)	3820	1720
Hardened die steel (SKD61, DAC, DHA) 42-52HRC	DH103 JC8015	0.1	2.0(~9)	3780	570	0.15	2.5(~13)	3020	680
Grey cast iron (FC250) 160-260HB	DH103 JC8015	0.2	2.0(~9)	5970	2390	0.2	2.5(~13)	4770	2860
Nodular cast iron (FCD700) 170-300HB	DH103 JC8015	0.2	2.0(~9)	5970	2390	0.2	2.5(~13)	4770	2860
Austenitic stainless steel (SUS304, 316, 317) 17Cr	JC8015	0.15	2.0(~9)	4770	1910	0.15	2.5(~13)	3820	2290
Ferritic & martensitic stainless steel (SUS403, 420J2, 430) 13Cr	JC8015	0.15	2.0(~9)	4770	1910	0.15	2.5(~13)	3820	2290
Titanium alloy (Ti-6Al-4V) 35-43HRC	JC8015	0.15	2.0(~9)	1090	220	0.2	2.5(~13)	880	260
Heat resistant alloy (INCO718) 35-43HRC	JC8015	0.15	2.0(~9)	1090	220	0.2	2.5(~13)	880	260

Note

1. Please adjust cutting conditions according to machine rigidity or work rigidity.
2. The above cutting conditions are for a overhung length of 3Dc.
Adjust the rotation speed n (min⁻¹) and feed rate V_f (mm/min) according to the protrusion length
3. If chattering occurs, reduce the depth of cut to a shallower depth than the above values or lower the feed rate.
4. Remove chips by air blow. Be especially careful when machining cavities with a vertical MC.
5. When using a steel shank, reduce the rotation speed n (min⁻¹) and feed rate V_f (mm/min) to 80% of the above conditions.

DIEMASTER 5G**MXF/XFG Type**

■ Recommended cutting conditions

■ Bottom finishing

Material	Grade	Tool dia.(mm)							
		25				35			
		4N				5N			
		a_p (mm)	a_e (mm)	n (min ⁻¹)	V_f (mm/min)	a_p (mm)	a_e (mm)	n (min ⁻¹)	V_f (mm/min)
Carbon steel (S50C, S55C) below 250HB	JC8015	0.2	4.0(~18)	3,310	2,650	0.2	4.3(~25)	2,360	2,360
Cast steel (GM190, ICD5) below 285HB	JC8015	0.2	4.0(~18)	3,310	2,650	0.2	4.3(~25)	2,360	2,360
Tool & die steel (SKD61, SKD11) below 255HB	JC8015	0.2	4.0(~18)	3,310	2,650	0.2	4.3(~25)	2,360	2,360
Mold steel (HPM7, PX5, P20) 30-36 HRC	DH103 JC8015	0.2	4.0(~18)	3,310	2,650	0.2	4.3(~25)	2,360	2,360
Mold steel (NAK80, HPM1, P21) 38-43HRC	DH103 JC8015	0.2	4.0(~18)	3,060	1,840	0.2	4.3(~25)	2,180	1,640
Hardened die steel (SKD61, DAC, DHA) 42-52HRC	DH103 JC8015	0.15	4.0(~18)	2,420	730	0.15	4.3(~25)	1,730	650
Grey cast iron (FC250) 160-260HB	DH103 JC8015	0.2	4.0(~18)	3,820	3,060	0.2	4.3(~25)	2,730	2,730
Nodular cast iron (FCD700) 170-300HB	DH103 JC8015	0.2	4.0(~18)	3,820	3,060	0.2	4.3(~25)	2,730	2,730
Austenitic stainless steel (SUS304, 316, 317) 17Cr	JC8015	0.15	4.0(~18)	3,060	2,450	0.15	4.3(~25)	2,180	2,180
Ferritic & martensitic stainless steel (SUS403, 420J2, 430) 13Cr	JC8015	0.15	4.0(~18)	3,060	2,450	0.15	4.3(~25)	2,180	2,180
Titanium alloy (Ti-6Al-4V) 35-43HRC	JC8015	0.2	4.0(~18)	700	280	0.2	4.3(~25)	500	250
Heat resistant alloy (INCO718) 35-43HRC	JC8015	0.2	4.0(~18)	700	280	0.2	4.3(~25)	500	250

Note

1. Please adjust cutting conditions according to machine rigidity or work rigidity.
2. The above cutting conditions are for a overhung length of 3Dc.
Adjust the rotation speed n (min⁻¹) and feed rate V_f (mm/min) according to the protrusion length
3. If chattering occurs, reduce the depth of cut to a shallower depth than the above values or lower the feed rate.
4. Remove chips by air blow. Be especially careful when machining cavities with a vertical MC.
5. When using a steel shank, reduce the rotation speed n (min⁻¹) and feed rate V_f (mm/min) to 80% of the above conditions.

DIEMASTER 5G**MXF/XFG Type**

■ Recommended cutting conditions

■ Bottom finishing

Material	Grade	Tool dia.(mm)							
		42				52			
		6N				6N			
		a_p (mm)	a_e (mm)	n (min ⁻¹)	V_f (mm/min)	a_p (mm)	a_e (mm)	n (min ⁻¹)	V_f (mm/min)
Carbon steel (S50C, S55C) below 250HB	JC8015	0.2	5.0(~29)	1,970	2,360	0.2	6.2(~36)	1,590	1,910
Cast steel (GM190, ICD5) below 285HB	JC8015	0.2	5.0(~29)	1,970	2,360	0.2	6.2(~36)	1,590	1,910
Tool & die steel (SKD61, SKD11) below 255HB	JC8015	0.2	5.0(~29)	1,970	2,360	0.2	6.2(~36)	1,590	1,910
Mold steel (HPM7, PX5, P20) 30-36 HRC	DH103 JC8015	0.2	5.0(~29)	1,970	2,360	0.2	6.2(~36)	1,590	1,910
Mold steel (NAK80, HPM1, P21) 38-43HRC	DH103 JC8015	0.2	5.0(~29)	1,820	1,640	0.2	6.2(~36)	1,470	1,320
Hardened die steel (SKD61, DAC, DHA) 42-52HRC	DH103 JC8015	0.15	5.0(~29)	1,440	650	0.15	6.2(~36)	1,160	520
Grey cast iron (FC250) 160-260HB	DH103 JC8015	0.2	5.0(~29)	2,270	2,720	0.2	6.2(~36)	1,840	2,210
Nodular cast iron (FCD700) 170-300HB	DH103 JC8015	0.2	5.0(~29)	2,270	2,720	0.2	6.2(~36)	1,840	2,210
Austenitic stainless steel (SUS304, 316, 317) 17Cr	JC8015	0.15	5.0(~29)	1,820	2,180	0.15	6.2(~36)	1,470	1,760
Ferritic & martensitic stainless steel (SUS403, 420J2, 430) 13Cr	JC8015	0.15	5.0(~29)	1,820	2,180	0.15	6.2(~36)	1,470	1,760
Titanium alloy (Ti-6Al-4V) 35-43HRC	JC8015	0.2	5.0(~29)	420	250	0.2	6.2(~36)	340	200
Heat resistant alloy (INCO718) 35-43HRC	JC8015	0.2	5.0(~29)	420	250	0.2	6.2(~36)	340	200

Note

1. Please adjust cutting conditions according to machine rigidity or work rigidity.
2. The above cutting conditions are for a overhung length of 3Dc.
Adjust the rotation speed n (min⁻¹) and feed rate V_f (mm/min) according to the protrusion length
3. If chattering occurs, reduce the depth of cut to a shallower depth than the above values or lower the feed rate.
4. Remove chips by air blow. Be especially careful when machining cavities with a vertical MC.
5. When using a steel shank, reduce the rotation speed n (min⁻¹) and feed rate V_f (mm/min) to 80% of the above conditions.

DIEMASTER 5G**MXF/XFG Type**

■ Recommended cutting conditions

■ Bottom finishing

Material	Grade	Tool dia.(mm)			
		66			
		7N			
		a_p (mm)	a_e (mm)	n (min ⁻¹)	V_f (mm/min)
Carbon steel (S50C, S55C) below 250HB	JC8015	0.2	7.9(~46)	1,250	1,750
Cast steel (GM190, ICD5) below 285HB	JC8015	0.2	7.9(~46)	1,250	1,750
Tool & die steel (SKD61, SKD11) below 255HB	JC8015	0.2	7.9(~46)	1,250	1,750
Mold steel (HPM7, PX5, P20) 30-36 HRC	DH103 JC8015	0.2	7.9(~46)	1,250	1,750
Mold steel (NAK80, HPM1, P21) 38-43HRC	DH103 JC8015	0.2	7.9(~46)	1,160	1,220
Hardened die steel (SKD61, DAC, DHA) 42-52HRC	DH103 JC8015	0.15	7.9(~46)	920	480
Grey cast iron (FC250) 160-260HB	DH103 JC8015	0.2	7.9(~46)	1,450	2,030
Nodular cast iron (FCD700) 170-300HB	DH103 JC8015	0.2	7.9(~46)	1,450	2,030
Austenitic stainless steel (SUS304, 316, 317) 17Cr	JC8015	0.15	7.9(~46)	1,160	1,620
Ferritic & martensitic stainless steel (SUS403, 420J2, 430) 13Cr	JC8015	0.15	7.9(~46)	1,160	1,620
Titanium alloy (Ti-6Al-4V) 35-43HRC	JC8015	0.2	7.9(~46)	270	190
Heat resistant alloy (INCO718) 35-43HRC	JC8015	0.2	7.9(~46)	270	190

Note

1. Please adjust cutting conditions according to machine rigidity or work rigidity.
2. The above cutting conditions are for a overhung length of 3Dc.
Adjust the rotation speed n (min-1) and feed rate V_f (mm/min) according to the protrusion length
3. If chattering occurs, reduce the depth of cut to a shallower depth than the above values or lower the feed rate.
4. Remove chips by air blow. Be especially careful when machining cavities with a vertical MC.
5. When using a steel shank, reduce the rotation speed n (min-1) and feed rate V_f (mm/min) to 80% of the above conditions.

DIEMASTER 5G**MXF/XFG Type**

■ Recommended cutting conditions

■ Semi finishing

Material	Grade	Tool dia.(mm)									
		16					20				
		2N					3N				
		r (mm)	ap (mm)	ae (mm)	n (min ⁻¹)	Vf (mm/min)	r (mm)	ap (mm)	ae (mm)	n (min ⁻¹)	Vf (mm/min)
Carbon steel (S50C, S55C) below 250HB	JC8015	35	0.2	7	3,780	4,540	40	0.2	9.8	3,020	5,440
		80	0.2	7	3,780	3,780	100	0.2	9.8	3,020	4,530
		120	0.2	7	3,780	3,020	150	0.2	9.8	3,020	3,620
		160	0.2	7	3,780	2,270	200	0.2	9.8	3,020	2,720
Cast steel (GM190, ICD5) below 285HB	JC8015	35	0.2	7	3,780	4,540	40	0.2	9.8	3,020	5,440
		80	0.2	7	3,780	3,780	100	0.2	9.8	3,020	4,530
		120	0.2	7	3,780	3,020	150	0.2	9.8	3,020	3,620
		160	0.2	7	3,780	2,270	200	0.2	9.8	3,020	2,720
Tool & die steel (SKD61, SKD11) below 255HB	JC8015	35	0.2	7	3,480	4,180	40	0.2	9.8	2,790	5,020
		80	0.2	7	3,480	3,480	100	0.2	9.8	2,790	4,190
		120	0.2	7	3,480	2,780	150	0.2	9.8	2,790	3,350
		160	0.2	7	3,480	2,090	200	0.2	9.8	2,790	2,510
Mold steel (HPM7, PX5, P20) 30-36 HRC	DH103 JC8015	35	0.2	7	3,480	4,180	40	0.2	9.8	2,790	5,020
		80	0.2	7	3,480	3,480	100	0.2	9.8	2,790	4,190
		120	0.2	7	3,480	2,780	150	0.2	9.8	2,790	3,350
		160	0.2	7	3,480	2,090	200	0.2	9.8	2,790	2,510
Mold steel (NAK80, HPM1, P21) 38-43HRC	DH103 JC8015	35	0.2	7	3,180	3,820	40	0.2	9.8	2,550	4,590
		80	0.2	7	3,180	3,180	100	0.2	9.8	2,550	3,830
		120	0.2	7	3,180	2,540	150	0.2	9.8	2,550	3,060
		160	0.2	7	3,180	1,910	200	0.2	9.8	2,550	2,300
Hardened die steel (SKD61, DAC, DHA) 42-52HRC	DH103 JC8015	35	0.2	7	2,980	3,580	40	0.2	9.8	2,390	4,300
		80	0.2	7	2,980	2,980	100	0.2	9.8	2,390	3,590
		120	0.2	7	2,980	2,380	150	0.2	9.8	2,390	2,870
		160	0.2	7	2,980	1,790	200	0.2	9.8	2,390	2,150
Grey cast iron (FC250) 160-260HB	DH103 JC8015	35	0.2	7	3,180	3,820	40	0.2	9.8	2,550	4,590
		80	0.2	7	3,180	3,180	100	0.2	9.8	2,550	3,830
		120	0.2	7	3,180	2,540	150	0.2	9.8	2,550	3,060
		160	0.2	7	3,180	1,910	200	0.2	9.8	2,550	2,300
Nodular cast iron (FCD700) 170-300HB	DH103 JC8015	35	0.2	7	3,180	3,820	40	0.2	9.8	2,550	4,590
		80	0.2	7	3,180	3,180	100	0.2	9.8	2,550	3,830
		120	0.2	7	3,180	2,540	150	0.2	9.8	2,550	3,060
		160	0.2	7	3,180	1,910	200	0.2	9.8	2,550	2,300
Austenitic stainless steel (SUS304, 316, 317) 17Cr	JC8015	35	0.2	7	3,380	4,060	40	0.2	9.8	2,710	4,880
		80	0.2	7	3,380	3,380	100	0.2	9.8	2,710	4,070
		120	0.2	7	3,380	2,700	150	0.2	9.8	2,710	3,250
		160	0.2	7	3,380	2,030	200	0.2	9.8	2,710	2,440
Ferritic & martensitic stainless steel (SUS403, 420J2, 430) 13Cr	JC8015	35	0.2	7	3,380	4,060	40	0.2	9.8	2,710	4,880
		80	0.2	7	3,380	3,380	100	0.2	9.8	2,710	4,070
		120	0.2	7	3,380	2,700	150	0.2	9.8	2,710	3,250
		160	0.2	7	3,380	2,030	200	0.2	9.8	2,710	2,440

Note

1. The above cutting conditions should be adjusted according to the machine rigidity and workpiece rigidity.
2. If chattering occurs, reduce the depth of cut to a shallower depth than the above values or lower the feed rate.
3. Remove chips by air blow. Be especially careful when machining cavities with a vertical MC.
4. When using a steel shank, reduce the rotation speed n (min⁻¹) and feed rate Vf (mm/min) to 80% of the above conditions.

DIEMASTER 5G**MXF/XFG Type**

■ Recommended cutting conditions

■ Semi finishing

Material	Grade	Tool dia.(mm)									
		25					35				
		4N					5N				
		r (mm)	ap (mm)	ae (mm)	n (min ⁻¹)	Vf (mm/min)	r (mm)	ap (mm)	ae (mm)	n (min ⁻¹)	Vf (mm/min)
Carbon steel (S50C, S55C) below 250HB	JC8015	60	0.2	12	2,420	5,810	70	0.2	17	1,730	5,190
		125	0.2	12	2,420	4,840	175	0.2	17	1,730	4,330
		190	0.2	12	2,420	3,870	265	0.2	17	1,730	3,460
		250	0.2	12	2,420	2,900	350	0.2	17	1,730	2,600
Cast steel (GM190, ICD5) below 285HB	JC8015	60	0.2	12	2,420	5,810	40	0.2	17	1,730	5,190
		125	0.2	12	2,420	4,840	100	0.2	17	1,730	4,330
		190	0.2	12	2,420	3,870	150	0.2	17	1,730	3,460
		250	0.2	12	2,420	2,900	200	0.2	17	1,730	2,600
Tool & die steel (SKD61, SKD11) below 255HB	JC8015	60	0.2	12	2,230	5,350	40	0.2	17	1,590	4,770
		125	0.2	12	2,230	4,460	100	0.2	17	1,590	3,980
		190	0.2	12	2,230	3,570	150	0.2	17	1,590	3,180
		250	0.2	12	2,230	2,680	200	0.2	17	1,590	2,390
Mold steel (HPM7, PX5, P20) 30-36 HRC	DH103 JC8015	60	0.2	12	2,230	5,350	40	0.2	17	1,590	4,770
		125	0.2	12	2,230	4,460	100	0.2	17	1,590	3,980
		190	0.2	12	2,230	3,570	150	0.2	17	1,590	3,180
		250	0.2	12	2,230	2,680	200	0.2	17	1,590	2,390
Mold steel (NAK80, HPM1, P21) 38-43HRC	DH103 JC8015	60	0.2	12	2,040	4,900	40	0.2	17	1,460	4,380
		125	0.2	12	2,040	4,080	100	0.2	17	1,460	3,650
		190	0.2	12	2,040	3,260	150	0.2	17	1,460	2,920
		250	0.2	12	2,040	2,450	200	0.2	17	1,460	2,190
Hardened die steel (SKD61, DAC, DHA) 42-52HRC	DH103 JC8015	60	0.2	12	1,910	4,580	40	0.2	17	1,360	4,080
		125	0.2	12	1,910	3,820	100	0.2	17	1,360	3,400
		190	0.2	12	1,910	3,060	150	0.2	17	1,360	2,720
		250	0.2	12	1,910	2,290	200	0.2	17	1,360	2,040
Grey cast iron (FC250) 160-260HB	DH103 JC8015	60	0.2	12	2,040	4,900	40	0.2	17	1,460	4,380
		125	0.2	12	2,040	4,080	100	0.2	17	1,460	3,650
		190	0.2	12	2,040	3,260	150	0.2	17	1,460	2,920
		250	0.2	12	2,040	2,450	200	0.2	17	1,460	2,190
Nodular cast iron (FCD700) 170-300HB	DH103 JC8015	60	0.2	12	2,040	4,900	40	0.2	17	1,460	4,380
		125	0.2	12	2,040	4,080	100	0.2	17	1,460	3,650
		190	0.2	12	2,040	3,260	150	0.2	17	1,460	2,920
		250	0.2	12	2,040	2,450	200	0.2	17	1,460	2,190
Austenitic stainless steel (SUS304, 316, 317) 17Cr	JC8015	60	0.2	12	2,160	5,180	40	0.2	17	1,550	4,650
		125	0.2	12	2,160	4,320	100	0.2	17	1,550	3,880
		190	0.2	12	2,160	3,460	150	0.2	17	1,550	3,100
		250	0.2	12	2,160	2,590	200	0.2	17	1,550	2,330
Ferritic & martensitic stainless steel (SUS403, 420J2, 430) 13Cr	JC8015	60	0.2	12	2,160	5,180	40	0.2	17	1,550	4,650
		125	0.2	12	2,160	4,320	100	0.2	17	1,550	3,880
		190	0.2	12	2,160	3,460	150	0.2	17	1,550	3,100
		250	0.2	12	2,160	2,590	200	0.2	17	1,550	2,330

Note

1. The above cutting conditions should be adjusted according to the machine rigidity and workpiece rigidity.
2. If chattering occurs, reduce the depth of cut to a shallower depth than the above values or lower the feed rate.
3. Remove chips by air blow. Be especially careful when machining cavities with a vertical MC.
4. When using a steel shank, reduce the rotation speed n (min⁻¹) and feed rate Vf (mm/min) to 80% of the above conditions.

DIEMASTER 5G

MXF/XFG Type

■ Recommended cutting conditions

■ Semi finishing

Material	Grade	Tool dia.(mm)									
		42					52				
		6N					6N				
		r (mm)	ap (mm)	ae (mm)	n (min ⁻¹)	Vf (mm/min)	r (mm)	ap (mm)	ae (mm)	n (min ⁻¹)	Vf (mm/min)
Carbon steel (S50C, S55C) below 250HB	JC8015	100	0.2	20	1,440	5,180	150	0.2	26	1,160	4,180
		210	0.2	20	1,440	4,320	250	0.2	26	1,160	3,480
		315	0.2	20	1,440	3,460	350	0.2	26	1,160	2,780
		420	0.2	20	1,440	2,590	—	—	—	—	—
Cast steel (GM190, ICD5) below 285HB	JC8015	100	0.2	20	1,440	5,180	150	0.2	26	1,160	4,180
		210	0.2	20	1,440	4,320	250	0.2	26	1,160	3,480
		315	0.2	20	1,440	3,460	350	0.2	26	1,160	2,780
		420	0.2	20	1,440	2,590	—	—	—	—	—
Tool & die steel (SKD61, SKD11) below 255HB	JC8015	100	0.2	20	1,330	4,790	150	0.2	26	1,070	3,850
		210	0.2	20	1,330	3,990	250	0.2	26	1,070	3,210
		315	0.2	20	1,330	3,190	350	0.2	26	1,070	2,570
		420	0.2	20	1,330	2,390	—	—	—	—	—
Mold steel (HPM7, PX5, P20) 30-36 HRC	DH103 JC8015	100	0.2	20	1,330	4,790	150	0.2	26	1,070	3,850
		210	0.2	20	1,330	3,990	250	0.2	26	1,070	3,210
		315	0.2	20	1,330	3,190	350	0.2	26	1,070	2,570
		420	0.2	20	1,330	2,390	—	—	—	—	—
Mold steel (NAK80, HPM1, P21) 38-43HRC	DH103 JC8015	100	0.2	20	1,210	4,360	150	0.2	26	980	3,530
		210	0.2	20	1,210	3,630	250	0.2	26	980	2,940
		315	0.2	20	1,210	2,900	350	0.2	26	980	2,350
		420	0.2	20	1,210	2,180	—	—	—	—	—
Hardened die steel (SKD61, DAC, DHA) 42-52HRC	DH103 JC8015	100	0.2	20	1,140	4,100	150	0.2	26	920	3,310
		210	0.2	20	1,140	3,420	250	0.2	26	920	2,760
		315	0.2	20	1,140	2,740	350	0.2	26	920	2,210
		420	0.2	20	1,140	2,050	—	—	—	—	—
Grey cast iron (FC250) 160-260HB	DH103 JC8015	100	0.2	20	1,210	4,360	150	0.2	26	980	3,530
		210	0.2	20	1,210	3,630	250	0.2	26	980	2,940
		315	0.2	20	1,210	2,900	350	0.2	26	980	2,350
		420	0.2	20	1,210	2,180	—	—	—	—	—
Nodular cast iron (FCD700) 170-300HB	DH103 JC8015	100	0.2	20	1,210	4,360	150	0.2	26	980	3,530
		210	0.2	20	1,210	3,630	250	0.2	26	980	2,940
		315	0.2	20	1,210	2,900	350	0.2	26	980	2,350
		420	0.2	20	1,210	2,180	—	—	—	—	—
Austenitic stainless steel (SUS304, 316, 317) 17Cr	JC8015	100	0.2	20	1,290	4,640	150	0.2	26	1,040	3,740
		210	0.2	20	1,290	3,870	250	0.2	26	1,040	3,120
		315	0.2	20	1,290	3,100	350	0.2	26	1,040	2,500
		420	0.2	20	1,290	2,320	—	—	—	—	—
Ferritic & martensitic stainless steel (SUS403, 420J2, 430) 13Cr	JC8015	100	0.2	20	1,290	4,640	150	0.2	26	1,040	3,740
		210	0.2	20	1,290	3,870	250	0.2	26	1,040	3,120
		315	0.2	20	1,290	3,100	350	0.2	26	1,040	2,500
		420	0.2	20	1,290	2,320	—	—	—	—	—

Note

1. The above cutting conditions should be adjusted according to the machine rigidity and workpiece rigidity.
2. If chattering occurs, reduce the depth of cut to a shallower depth than the above values or lower the feed rate.
3. Remove chips by air blow. Be especially careful when machining cavities with a vertical MC.
4. When using a steel shank, reduce the rotation speed n (min⁻¹) and feed rate Vf (mm/min) to 80% of the above conditions.

DIEMASTER 5G**MXF/XFG Type**

■ Recommended cutting conditions

■ Semi finishing

Material	Grade	Tool dia.(mm)				
		66				
		7N				
		r (mm)	ap (mm)	ae (mm)	n (min ⁻¹)	Vf (mm/min)
Carbon steel (S50C, S55C) below 250HB	JC8015	200	0.2	33	920	3,860
		350	0.2	33	920	3,220
		450	0.2	33	920	2,580
		—	—	—	—	—
Cast steel (GM190, ICD5) below 285HB	JC8015	200	0.2	33	920	3,860
		350	0.2	33	920	3,220
		450	0.2	33	920	2,580
		—	—	—	—	—
Tool & die steel (SKD61, SKD11) below 255HB	JC8015	200	0.2	33	840	3,530
		350	0.2	33	840	2,940
		450	0.2	33	840	2,350
		—	—	—	—	—
Mold steel (HPM7, PX5, P20) 30-36 HRC	DH103 JC8015	200	0.2	33	840	3,530
		350	0.2	33	840	2,940
		450	0.2	33	840	2,350
		—	—	—	—	—
Mold steel (NAK80, HPM1, P21) 38-43HRC	DH103 JC8015	200	0.2	33	770	3,230
		350	0.2	33	770	2,700
		450	0.2	33	770	2,160
		—	—	—	—	—
Hardened die steel (SKD61, DAC, DHA) 42-52HRC	DH103 JC8015	200	0.2	33	720	3,020
		350	0.2	33	720	2,520
		450	0.2	33	720	2,020
		—	—	—	—	—
Grey cast iron (FC250) 160-260HB	DH103 JC8015	200	0.2	33	770	3,230
		350	0.2	33	770	2,700
		450	0.2	33	770	2,160
		—	—	—	—	—
Nodular cast iron (FCD700) 170-300HB	DH103 JC8015	200	0.2	33	770	3,230
		350	0.2	33	770	2,700
		450	0.2	33	770	2,160
		—	—	—	—	—
Austenitic stainless steel (SUS304, 316, 317) 17Cr	JC8015	200	0.2	33	820	3,440
		350	0.2	33	820	2,870
		450	0.2	33	820	2,300
		—	—	—	—	—
Ferritic & martensitic stainless steel (SUS403, 420J2, 430) 13Cr	JC8015	200	0.2	33	820	3,440
		350	0.2	33	820	2,870
		450	0.2	33	820	2,300
		—	—	—	—	—

Note

1. The above cutting conditions should be adjusted according to the machine rigidity and workpiece rigidity.
2. If chattering occurs, reduce the depth of cut to a shallower depth than the above values or lower the feed rate.
3. Remove chips by air blow. Be especially careful when machining cavities with a vertical MC.
4. When using a steel shank, reduce the rotation speed n (min⁻¹) and feed rate Vf (mm/min) to 80% of the above conditions.

DIEMASTER 5G**MXF/XFG Type**

■ Recommended cutting conditions

■ Plunge finishing

Material	Grade	V _c (mm/min)	f _z (mm/t)	a _e (mm)	P _f (mm)
Carbon steel (S50C, S55C) below 250HB	JC8015	400	0.1	- 0.2	Calculate from theoretical surface finish roughness
Cast steel (GM190, ICD5) below 285HB	JC8015	400	0.1	- 0.2	
Tool & die steel (SKD61, SKD11) below 255HB	JC8015	350	0.1	- 0.2	
Mold steel (HPM7, PX5, P20) 30-36 HRC	DH103 JC8015	300	0.1	- 0.2	
Mold steel (NAK80, HPM1, P21) 38-43HRC	DH103 JC8015	200	0.1	- 0.2	
Hardened die steel (SKD61, DAC, DHA) 42-52HRC	DH103 JC8015	140	0.07	- 0.2	
Grey cast iron (FC250) 160-260HB	DH103 JC8015	500	0.1	- 0.2	
Nodular cast iron (FCD700) 170-300HB	DH103 JC8015	500	0.1	- 0.2	

Note

1. The above cutting conditions should be adjusted according to the machine rigidity and workpiece rigidity.
2. The above cutting conditions are for a protrusion length of 3Dc.
Adjust the rotation speed n (min⁻¹) and feed rate Vf (mm/min) according to the protrusion length.
3. If chattering occurs, reduce the depth of cut to a shallower depth than the above values or lower the feed rate.
4. Remove chips by air blow. Be especially careful when machining cavities with a vertical MC.
5. When using a steel shank, reduce the rotation speed n (min⁻¹) and feed rate Vf (mm/min) to 80% of the above conditions.
6. For up and down milling, use a_e = 0.1 mm or less. .

DIEMASTER 5G**MXF/XFG Type**■ **Recommended cutting conditions**■ **Plunge semi finishing**

Material	Grade	V _c (mm/min)	f _z (mm/t)	a _e (mm)	P _f (mm)
Carbon steel (S50C, S55C) below 250HB	JC8015	300	0.15	~2	~0.15Dc
Cast steel (GM190, ICD5) below 285HB	JC8015	300	0.15	~2	~0.15Dc
Tool & die steel (SKD61, SKD11) below 255HB	JC8015	260	0.15	~2	~0.15Dc
Mold steel (HPM7, PX5, P20) 30-36 HRC	DH103 JC8015	220	0.12	~2	~0.15Dc
Mold steel (NAK80, HPM1, P21) 38-43HRC	DH103 JC8015	150	0.12	~2	~0.15Dc
Hardened die steel (SKD61, DAC, DHA) 42-52HRC	DH103 JC8015	100	0.1	~2	~0.15Dc
Grey cast iron (FC250) 160-260HB	DH103 JC8015	370	0.15	~2	~0.15Dc
Nodular cast iron (FCD700) 170-300HB	DH103 JC8015	370	0.15	~2	~0.15Dc

Note

1. The above cutting conditions should be adjusted according to the machine rigidity and workpiece rigidity.
2. The above cutting conditions are for a protrusion length of 3Dc.
Adjust the rotation speed n (min⁻¹) and feed rate Vf (mm/min) according to the protrusion length.
3. If chattering occurs, reduce the depth of cut to a shallower depth than the above values or lower the feed rate.
4. Remove chips by air blow. Be especially careful when machining cavities with a vertical MC.
5. When using a steel shank, reduce the rotation speed n (min⁻¹) and feed rate Vf (mm/min) to 80% of the above conditions.
6. For up and down milling, use a_e = 0.1 mm or less. .

SUPER DIEMASTER

HDM/SDH Type

■ HDM Type - Facemill / Standard Pitch

High Efficient Indexable Radius Tool

- High rigidity insert for stable machining.
- Positive axial rake reduces cutting force.



Through coolant hole

Double - Clamping

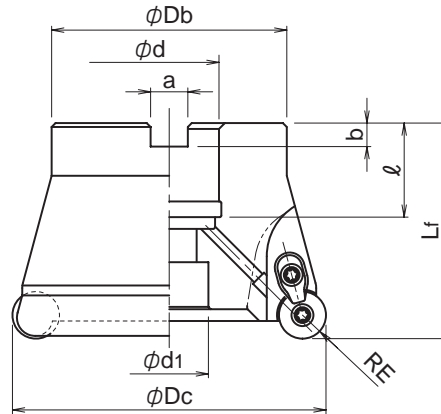

Cat.No.	Stock	No. of inserts	Dimensions(mm)									Arbor set bolt	Parts		Weight (kg)	Inserts
			φDc	RE	Lf	φDb	φd	φd1	a	b	ℓ		Screw	Wrench		
HDM-3050-12R-22	●	3	50	6	50	47	22	16.5	10.4	6.3	20	M10	DSW-410H	A-15T	0.5	RD**1204MO...
HDM-3050-16R-22	●			8	55							M10	DSW-4512H	A-20	0.5	RD**1606MO...
HDM-4063-12R-22	●	4	63	6	50	60	22	16.5	10.4	6.3	20	M10	DSW-410H	A-15T	0.7	RD**1204MO...
HDM-4063-16R-22	●			8	50							M10	DSW-4512H	A-20	0.7	RD**1606MO...

Screw	Torque (N.m)
DSW-410H	3.6
DSW-4512H	6.0

MD	Hexagonal wrench(mm) for Arbor set bolt
M10	8
M12	10
M16	14
M20	17
M24	19

Inserts	Screw	Clamp	Wrench
RD**1204MO*	DSW-410H	DCM-18	A-15T
RD**1606MO*	DSW-4512H	DCM-17	A-20

SUPER DIEMASTER **HDM/SDH Type**

■ HDM Type - Facemill / Fine Pitch

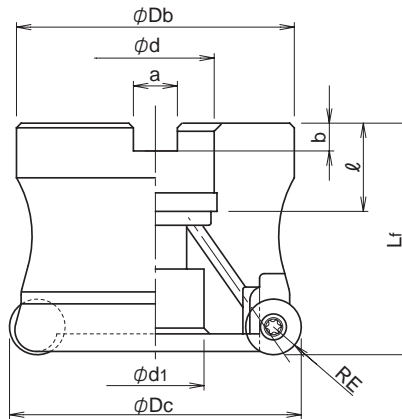
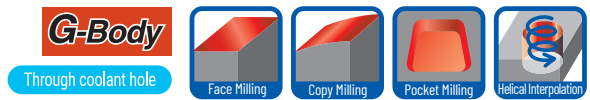

Cat.No.	Stock	No. of inserts	Dimensions(mm)									Arbor set bolt	Weight (kg)	Parts		Inserts
			φDc	RE	Lf	φDb	φd	φd1	a	b	ℓ			Screw	Wrench	
HDM-4050-R-22	●	4	50	8	55	47	22	16.5	10.4	6.3	20	M10	0.4	DSW-4512H	A-20	RD**1606MO...
HDM-5050-R-22	●	5		6								40	M10	0.4	DSW-410H	A-15T
HDM-5052-R-22	●	5	52	6	50	40	27	20	12.4	7	22	M10	0.5	DSW-410H	A-15T	RD**1204MO...
HDM-5063-R-27	●	6	63	8								60	M12	0.7	DSW-4512H	A-20
HDM-6063-R-27	●	6	63	6	55	60	27	20	12.4	7	22	M12	0.8	DSW-410H	A-15T	RD**1204MO...
HDM-6080-R-27	●	6	80	8								M12	1.3	DSW-4512H	A-20	RD**1606MO...
HDM-7080-R-27	●	7	80	6	55	76						M12	1.4	DSW-410H	A-15T	RD**1204MO...

Screw	Torque (N.m)
DSW-4512H	6
DSW-410H	3.6

MD	Hexagonal wrench(mm) for Arbor set bolt
M10	8
M12	10
M16	14
M20	17
M24	19

Inserts	Screw	Wrench
RD**1204MO*	DSW-410H	A-15T
RD**1606MO*	DSW-4512H	A-20

SUPER DIEMASTER

HDM/SDH Type

■ SDH Type - Modular Head / Standard Pitch

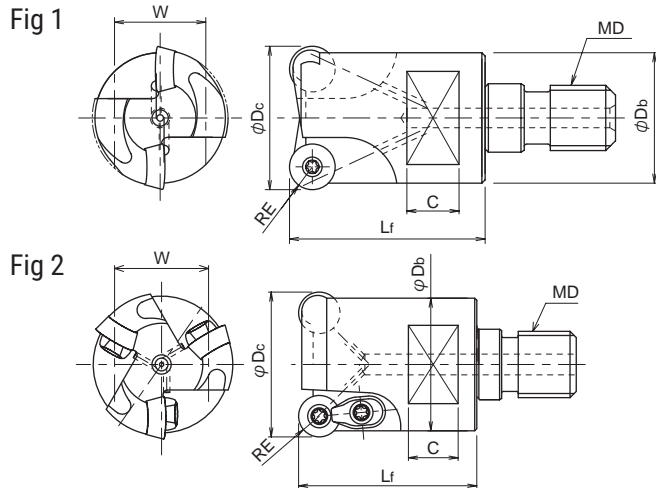
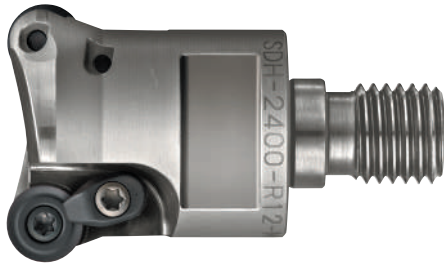

Cat.No.	Stock	No. of inserts	Dimensions(mm)							Parts			Inserts	Fig.
			ϕD_c	RE	Lf	ϕD_b	MD	C	W	Screw	Clamp	Wrench		
SDH-2150-R07-M8	●	2	15	3.5	23	13.8	M8	8	12	TSW-2556H	-	A-08SD	RD**07T2MO...	1
SDH-2160-R07-M8	●		16			M8	15							
SDH-2200-R07-M10	●		20		18	M10	18							
SDH-2220-R07-M10	●		22		20	M10	20							
SDH-2250-R10-M12	●	3	25	5	35	23	M12	10	17	CSW-408H	DCM-18	A-15	RD**1004MO...	2
SDH-2280-R10-M12	●		28			M12	25							
SDH-2300-R10-M16	●		30	43	28	M16	12	22	DSW-410H	RD**1204MO...				
SDH-2320-R12-M16	●		32			M16			CSW-408H		RD**1004MO...			
SDH-3320-R10-M16	●		5			M16			CSW-408H		RD**1004MO...			
SDH-2350-R12-M16	●		6			M16			DSW-410H		RD**1204MO...			
SDH-3350-R10-M16	●		35	32	M16	13	26	CSW-408H	RD**1004MO...					
SDH-2400-R12-M16	●		2					40	6	M16	DSW-410H	RD**1204MO...		

Screw	Torque (N.m)
TSW-2556H	1.1
CSW-408H	3.6
DSW-410H	3.6

SUPER DIEMASTER **HDM/SDH Type**

■ SDH Type - Modular Head / Fine Pitch

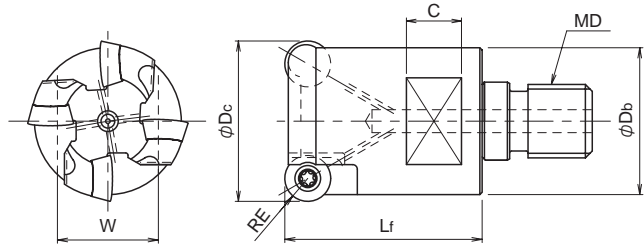
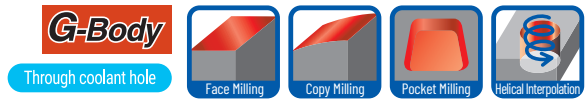

Cat.No.	Stock	No. of inserts	Dimensions(mm)						Parts		Inserts	
			φDc	RE	Lf	φDb	MD	C	W	Screw		Wrench
SDH-3200-R07-M10	●	3	20	3.5	30	18	M10	8	14	TSW-2556H	A-08SD	RD**07T2MO...
SDH-3220-R07-M10	●		22			20						
SDH-3250-R07-M12	●		25	35	5	23	M12	10	17	CSW-408H	A-15	RD**1004MO...
SDH-3250-R10-M12	●	28	25									
SDH-3280-R10-M12	●	30	28			43	M16	12	22	DSW-410H	RD**1204MO...	
SDH-3300-R10-M16	●	32										
SDH-4300-R10-M16	●	35		M16	13							26
SDH-4320-R10-M16	●	40										
SDH-3350-R12-M16	●	4	6	32	M16	13	26	CSW-408H	RD**1204MO...			
SDH-4350-R10-M16	●	5										
SDH-4400-R12-M16	●	4	6	32	M16	13	26	CSW-408H	RD**1204MO...			
SDH-4400-R12-M16	●	5										
SDH-5420-R10-M16	●	5	42	5	M16	13	26	CSW-408H	RD**1004MO...			

Screw	Torque (N.m)
TSW-2556H	1.1
CSW-408H	3.6
DSW-410H	3.6

SUPER DIEMASTER **HDM/SDH Type**

Insert

- Standard type
- Flat top inert
- for General steel

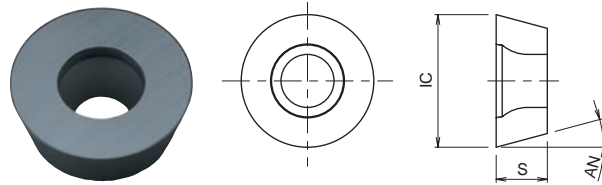

Cat.No.	Tolerance	PVD Coating			Dimensions(mm)		
		DH103	JC5040	JC8015	IC	S	AN
RDMW07T2MOT	M	●	●	●	7	2.7	15°
RDMW1004MOT		●	●	●	10	4.1	
RDMW1204MOT		●	●	●	12	4.8	
RDMW1606MOT		●	●	●	16	6	

- Low cutting force
- Chip breaker style
- for Titanium + Inconel
- for Stainless steel

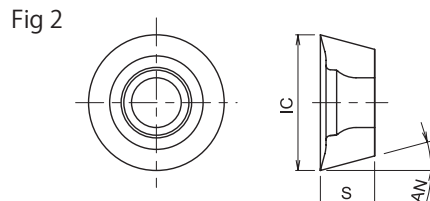
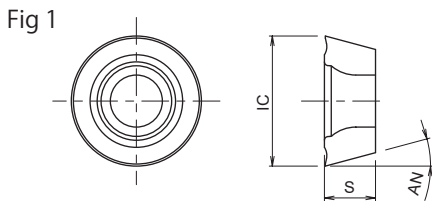

Cat.No.	Tolerance	PVD Coating			Dimensions(mm)			Fig.
		JC8015	JC8050	JC8118	IC	S	AN	
RDGT07T2MOE	G	●	●		7	2.7	15°	1
RDGT1004MOE		●	●		10	4.1		
RDGT1004MOT		●	●		12	4.8		
RDGT1204MOE		●	●		16	6		
RDGT1204MOT		●	●					
RDGT1606MOE		●	●					
RDMT07T2MOE	M		●	●	7	2.7	15°	2
RDMT1004MOE			●	●	10	4.1		
RDMT1004MOE-ML			●	●				
RDMT1004MOT			●	●	12	4.8		
RDMT1204MOE			●	●				
RDMT1204MOE-ML			●	●	16	6		
RDMT1204MOT			●	●				
RDMT1606MOE			●	●				
RDMT1606MOT			●	●				

SUPER DIEMASTER **HDM/SDH Type**

- Low cutting force
- Chip breaker style
- for Aluminium

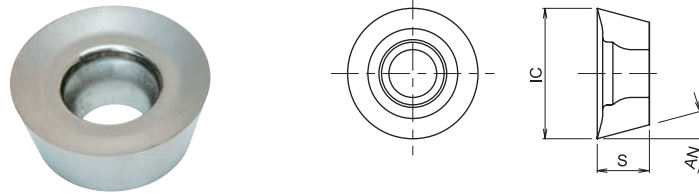

Cat.No.	Tolerance	Uncoated	Dimensions(mm)		
		FZ05	IC	S	AN
RDGT07T2MOF-AL	G	●	7	2.7	15°
RDGT1004MOF-AL		●	10	4.1	
RDGT1204MOF-AL		●	12	4.8	
RDGT1606MOF-AL		●	16	6	

SUPER DIEMASTER

HDM/SDH Type

Recommended Data for Profile Milling

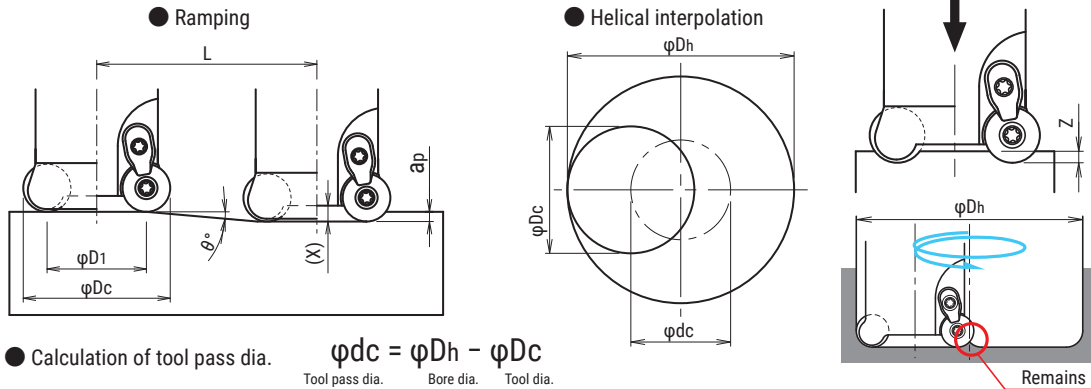

● Calculation of tool pass dia. $\phi_{dc} = \phi_{Dh} - \phi_{Dc}$
Tool pass dia. Bore dia. Tool dia.

- Depth of cut per one circuit should not exceed max. depth of cut A_p .
- Down cutting is recommended, tool pass rotation should be counterclockwise
- Do not combine drilling and ramping together

- In case of ramping and helical interpolation, apply 70% or less feed (V_f) from standard cutting condition table.
- In case of drilling, apply 50% or less feed (V_f) from standard cutting condition table.
- Long chips may come out in case of drilling, confirm safe operating conditions.

Tool dia. (mm)	Insert dia. (R) (mm)	Effective cutting dia. ϕD_1 (mm)	Min. Bore dia. D_h min (mm)	Max. Bore dia. D_h max (mm)	Max. ramping angle: θ	Max. depth of cut: a_p (mm)	Max. depth of cut (a_p) Total cutting length: L (mm)	Max. drilling length: Z (mm)	Depth of holder face: X (mm)
15	7 (R3.5)	8	20	28	3°00'	3.5	66.8	0.4	1.0
16	7 (R3.5)	9	22	30	9°00'	3.5	22.1	1.5	2.5
20	7 (R3.5)	13	30	38	5°30'	3.5	36.3	1.5	2.5
22	7 (R3.5)	15	34	42	4°35'	3.5	43.6	1.5	2.5
25	7 (R3.5)	18	40	48	3°40'	3.5	54.6	1.5	2.5
25	10 (R5)	15	34	48	10°45'	5.0	26.3	2.5	3.5
28	10 (R5)	18	40	54	8°20'	5.0	34.1	2.5	3.5
30	10 (R5)	20	44	58	7°15'	5.0	39.3	2.5	3.5
32	10 (R5)	22	48	62	6°25'	5.0	44.4	2.5	3.5
32	12 (R6)	20	44	62	7°35'	6.0	45.1	2.5	3.5
35	10 (R5)	25	54	68	5°30'	5.0	51.9	2.5	3.5
35	12 (R6)	23	50	68	6°15'	6.0	54.7	2.5	3.5
40	12 (R6)	28	60	78	4°55'	6.0	69.7	2.5	3.5
42	10 (R5)	32	68	82	4°05'	5.0	70.0	2.5	3.5
50	12 (R6)	38	80	98	5°15'	6.0	65.2	3.5	4.5
50	16 (R8)	34	75	98	7°25'	8.0	61.4	4.0	5.0
52	12 (R6)	40	84	102	4°55'	6.0	69.7	3.5	4.5
52	16 (R8)	36	79	102	6°55'	8.0	65.9	4.0	5.0
63	12 (R6)	51	106	124	3°45'	6.0	91.5	3.5	4.5
63	16 (R8)	47	101	124	5°00'	8.0	91.4	4.0	5.0
66	12 (R6)	54	112	130	3°30'	6.0	98.1	3.5	4.5
66	16 (R8)	50	107	130	4°40'	8.0	98.0	4.0	5.0
80	12 (R6)	68	140	158	2°45'	6.0	124.9	3.5	4.5
80	16 (R8)	64	135	158	3°30'	8.0	130.7	4.0	5.0
100	16 (R8)	84	175	198	2°35'	8.0	177.3	4.0	5.0
125	16 (R8)	109	225	248	1°55'	8.0	239.1	4.0	5.0
160	16 (R8)	144	295	318	1°25'	8.0	223.5	4.0	5.0

SUPER DIEMASTER**HDM/SDH Type**

■ Recommended cutting conditions

● Facemill type / Standard pitch

Material	Grade	Tool dia.(mm)											
		50 (R6)				50 (R8)				63 (R6)			
		3N				3N				4N			
		ℓ (mm)	a _p (mm)	n (min ⁻¹)	V _f (mm/min)	ℓ (mm)	a _p (mm)	n (min ⁻¹)	V _f (mm/min)	ℓ (mm)	a _p (mm)	n (min ⁻¹)	V _f (mm/min)
Carbon steel (S50C, S55C) below 250HB	JC8050	150	3	1,250	1,090	150	4	1,260	1,100	150	3	980	1,140
	JC5040	200	2.5	1,250	1,160	200	3	1,260	1,210	200	2.7	980	1,300
	JC8118	250	2	880	870	250	2	880	980	250	2.2	690	910
		300	1.2	880	1,130	300	1.5	880	1,160	300	1.6	690	1,100
		350	0.7	750	950	350	1	760	1,000	350	1	590	1,010
		400	-	-	-	400	-	-	-	400	0.5	540	1,190
Mold steel (HPM7, PX5, NAK80, P20) 30-43HRC	JC8050	150	2.5	1,200	1,190	150	3.5	1,210	1,010	150	2.5	940	1,160
	JC8118	200	2	1,200	1,220	200	3	1,210	1,100	200	2.2	940	1,240
	JC8015 (over 40HRC)	250	1.1	840	1,130	250	2.5	850	940	250	1.6	660	970
		300	0.9	840	1,260	300	2	850	970	300	1.1	660	1,180
		350	0.5	720	1,180	350	1	730	1,110	350	0.7	560	1,120
		400	-	-	-	400	-	-	-	400	0.5	520	1,140
Tool & die steel (SKD61, SKD11) below 255HB	JC5040	150	3	1,180	1,030	150	4	1,200	1,040	150	3	930	1,080
	JC8118	200	2.5	1,180	1,130	200	3	1,200	1,180	200	2.7	930	1,120
		250	2	830	840	250	2	840	960	250	2.2	650	850
		300	1.2	830	1,000	300	1.5	840	1,100	300	1.6	650	1,040
		350	0.7	700	950	350	1	720	950	350	1	560	870
		400	-	-	-	400	-	-	-	400	0.5	510	1,100
Stainless steel (SUS304) below 250HB	JC8050	150	3	990	860	150	4	1,000	870	150	3	780	900
	JC8015	200	2.5	990	890	200	3	1,000	990	200	2.7	780	930
	JC8118	250	2	690	700	250	2	700	780	250	2.2	550	730
		300	1.2	690	860	300	1.5	700	920	300	1.6	550	830
		350	0.7	590	820	350	1	600	790	350	1	470	690
		400	-	-	-	400	-	-	-	400	0.5	430	940
Hardened die steel (SKD61, DAC, DHA) 40-50HRC	JC8015 *without chipbreaker (DH103 over 50HRC)	100	1.5	810	560	100	2	860	590	100	1.5	650	580
	JC8015 *without chipbreaker (DH103 over 50HRC)	150	1.2	810	610	150	1.8	860	620	150	1.2	650	650
		200	1	570	410	200	1.6	600	470	200	1	450	490
		250	0.8	570	510	250	1.2	600	520	250	0.8	450	520
		300	0.4	490	440	300	0.8	520	465	300	0.6	390	590
		350	-	-	-	350	-	-	-	350	0.3	360	620
Grey & Nodular cast iron (FC, FCD) below 300HB	JC8015	150	3	1,120	1,170	150	4	1,130	1,190	150	3	880	1,370
	JC8118	200	2.5	1,120	1,110	200	3	1,130	1,290	200	2.7	880	1,440
		250	2	780	960	250	2	790	1,060	250	2.2	620	1,120
		300	1.2	780	1,170	300	1.5	790	1,300	300	1.6	620	1,240
		350	0.7	670	920	350	1	680	900	350	1	530	1,160
		400	-	-	-	400	-	-	-	400	0.5	480	1,220
Titanium alloy 35-43HRC	JC8050	150	1	420	270	150	1.5	440	330	150	1	330	260
	JC8015	200	0.8	420	315	200	1.2	440	265	200	0.9	330	290
	JC8118	250	0.6	290	260	250	1	310	205	250	0.7	230	240
		300	0.4	290	305	300	0.8	310	230	300	0.5	230	295
		350	0.2	250	375	350	0.4	260	255	350	0.3	200	340
		400	-	-	-	400	-	-	-	400	0.2	180	360
Heat resistant alloy 35-43HRC	JC8015	150	1	210	135	150	1.5	220	145	150	1	165	130
	JC8118	200	0.8	210	155	200	1.2	220	165	200	0.9	165	160
	JC8050	250	0.6	150	135	250	1	150	115	250	0.7	120	130
		300	0.4	150	160	300	0.8	150	130	300	0.5	120	150
		350	0.2	130	195	350	0.4	130	155	350	0.3	100	165
		400	-	-	-	400	-	-	-	400	0.2	90	180
Aluminium alloy (A5052, A7075) below 50-110HB	FZ05	150	4.5	4,450	5,200	150	6	4,450	5,200	150	4.5	3,500	5,500
		200	4	4,450	5,400	200	5	4,450	5,400	200	4	3,500	5,700
		250	3.5	3,800	4,900	250	4	3,800	4,900	250	3.5	3,050	5,200
		300	2.5	3,200	5,000	300	3	3,200	5,000	300	2.5	2,500	5,200
		350	1.5	3,100	4,200	350	2	3,100	4,200	350	1.5	2,400	4,300
		400	1	2,550	3,000	400	1	2,550	3,000	400	1	2,000	3,200

Note 1. In case of cutting hard materials (50-55HRC), reduce a_p, n, V_f by 30% from standard conditions table.
2. Wet cutting is recommended when machining Titanium, Inconel. 3. Use air blow

SUPER DIEMASTER

HDM/SDH Type

- Recommended cutting conditions
- Facemill type / Standard pitch

Material	Grade	Tool dia. (mm)											
		63 (R8)				80 (R6)				80 (R8)			
		4N				4N				4N			
		ℓ (mm)	ap (mm)	n (min ⁻¹)	Vf (mm/min)	ℓ (mm)	ap (mm)	n (min ⁻¹)	Vf (mm/min)	ℓ (mm)	ap (mm)	n (min ⁻¹)	Vf (mm/min)
Carbon steel (S50C, S55C) below 250HB	JC8050	150	4	990	1,110	150	3	770	890	150	4	780	870
	JC5040	200	3	990	1,290	200	2.7	770	980	200	3	780	990
	JC8118	250	2	690	1,200	250	2.2	540	710	250	2	550	830
		300	1.5	690	1,210	300	1.6	540	820	300	1.5	550	960
		350	1	590	1,040	350	1	460	700	350	1	470	810
		400	0.5	540	1,360	400	0.5	420	920	400	0.5	430	1,080
Mold steel (HPM7, PX5, NAK80, P20) 30-43HRC	JC8050	150	3.5	950	1,140	150	2.5	740	780	150	3.5	740	890
	JC8118	200	3	950	1,250	200	2.2	740	970	200	3	740	970
	JC8015 (over 40HRC)	250	2.5	670	980	250	1.6	520	680	250	2.5	520	730
		300	2	670	1,020	300	1.1	520	930	300	2	520	770
		350	1	570	1,000	350	0.7	440	880	350	1	440	960
		400	0.5	520	1,330	400	0.5	410	900	400	0.5	410	1,050
Tool & die steel (SKD61, SKD11) below 255HB	JC5040	150	4	940	1,090	150	3	730	820	150	4	740	830
	JC8118	200	3	940	1,240	200	2.7	730	900	200	3	740	970
		250	2	660	970	250	2.2	510	670	250	2	520	770
		300	1.5	660	1,160	300	1.6	510	750	300	1.5	520	910
		350	1	560	980	350	1	440	670	350	1	440	770
		400	0.5	520	1,330	400	0.5	400	900	400	0.5	410	1,050
Stainless steel (SUS304) below 250HB	JC8050	150	4	790	920	150	3	610	710	150	4	610	710
	JC8015	200	3	790	1,040	200	2.7	610	750	200	3	610	800
	JC8118	250	2	550	850	250	2.2	430	560	250	2	430	630
		300	1.5	550	960	300	1.6	430	650	300	1.5	430	750
		350	1	470	800	350	1	370	540	350	1	370	630
		400	0.5	430	1,100	400	0.5	340	740	400	0.5	340	870
Hardened die steel (SKD61, DAC, DHA) 40-50HRC	JC8015 *without chipbreaker	100	2	660	600	100	1.5	500	480	100	2	510	470
	(DH103 over 50HRC)	150	1.8	660	610	150	1.2	500	500	150	1.8	510	490
		200	1.6	460	460	200	1	350	380	200	1.6	360	380
		250	1.2	460	500	250	0.8	350	420	250	1.2	360	390
		300	0.8	400	530	300	0.6	300	460	300	0.8	310	400
		350	0.4	370	470	350	0.3	280	390	350	0.4	280	380
Grey & Nodular Cast iron (FC, FCD) below 300HB	JC8015	150	4	890	1,240	150	3	690	970	150	4	700	980
	JC8118	200	3	890	1,350	200	2.7	690	1,020	200	3	700	1,060
		250	2	620	1,140	250	2.2	480	730	250	2	490	900
		300	1.5	620	1,310	300	1.6	480	820	300	1.5	490	1,010
		350	1	530	1,180	350	1	410	780	350	1	420	920
		400	0.5	490	1,250	400	0.5	380	830	400	0.5	390	1,000
Titanium alloy 35-43HRC	JC8050	150	1.5	340	300	150	1	250	200	150	1.5	260	260
	JC8015	200	1.3	340	325	200	0.9	250	240	200	1.3	260	200
	JC8118	250	1.1	240	240	250	0.7	180	190	250	1.1	180	170
		300	0.9	240	250	300	0.5	180	230	300	0.9	180	190
		350	0.6	200	290	350	0.3	150	250	350	0.6	160	215
		400	0.3	190	300	400	0.2	140	280	400	0.3	140	250
Heat resistant alloy 35-43HRC	JC8015	150	1.5	170	170	150	1	125	100	150	1.5	130	130
	JC8118	200	1.3	170	155	200	0.9	125	115	200	1.3	130	120
	JC8050	250	1.1	120	120	250	0.7	90	100	250	1.1	90	90
		300	0.9	120	130	300	0.5	90	115	300	0.9	90	85
		350	0.6	100	140	350	0.3	75	130	350	0.6	80	105
		400	0.3	95	180	400	0.2	70	140	400	0.3	70	125
Aluminium alloy (A5052, A7075) below 50-110HB	FZ05	150	6	3,500	5,500	150	4.5	2,800	4,400	150	6	2,800	4,400
		200	5	3,500	5,700	200	4	2,800	4,600	200	5	2,800	4,600
		250	4	3,050	5,200	250	3.5	2,350	4,000	250	4	2,350	4,000
		300	3	2,500	5,200	300	2.5	2,000	4,100	300	3	2,000	4,100
		350	2	2,400	4,300	350	1.5	1,900	3,400	350	2	1,900	3,400
		400	1	2,000	3,200	400	1	1,600	2,600	400	1	1,600	2,600

Note 1. In case of cutting hard materials (50-55HRC), reduce ap, n, Vf by 30% from standard conditions table.
 2. Wet cutting is recommended when machining Titanium, Inconel. 3. Use air blow

SUPER DIEMASTER **HDM/SDH Type**

- Recommended cutting conditions
- Facemill type / Standard pitch

Material	Grade	Tool dia.(mm)															
		80 (R8)				100 (R8)				125 (R8)				160 (R8)			
		5N				6N				8N				9N			
		ℓ (mm)	ap (mm)	n (min ⁻¹)	Vf (mm/min)	ℓ (mm)	ap (mm)	n (min ⁻¹)	Vf (mm/min)	ℓ (mm)	ap (mm)	n (min ⁻¹)	Vf (mm/min)	ℓ (mm)	ap (mm)	n (min ⁻¹)	Vf (mm/min)
Carbon steel (S50C, S55C) below 250HB	JC8050	150	4	780	1,050	150	4	620	1,040	150	4	490	820	150	4	380	640
	JC5040	200	3	780	1,190	200	3	620	1,180	200	3	490	930	200	3	380	720
	JC8118	250	2	550	1,000	250	2	430	970	250	2	340	770	250	2	270	610
		300	1.5	550	1,150	300	1.5	430	1,120	300	1.5	340	890	300	1.5	270	710
		350	1	470	970	350	1	370	950	350	1	290	750	350	1	230	600
400	0.5	430	1,300	400	0.5	370	1,390	400	0.5	290	1,090	400	0.5	230	870		
Mold steel (HPM7, PX5, NAK80, P20) 30-43HRC	JC8050	150	3.5	740	1,070	150	3.5	580	1,040	150	3.5	460	830	150	3.5	360	650
	JC8118	200	3	740	1,160	200	3	580	1,140	200	3	460	900	200	3	360	710
	JC8015 (over 40HRC)	250	2.5	520	880	250	2.5	400	840	250	2.5	320	670	250	2.5	250	530
		300	2	520	920	300	2	400	880	300	2	320	710	300	2	250	560
		350	1	440	1,150	350	1	350	1,140	350	1	270	880	350	1	220	720
400	0.5	410	1,260	400	0.5	350	1,300	400	0.5	270	1,040	400	0.5	220	850		
Tool & die steel (SKD61, SKD11) below 255HB	JC5040	150	4	740	1,070	150	4	580	970	150	4	460	770	150	4	360	610
	JC8118	200	3	740	1,160	200	3	580	1,140	200	3	460	900	200	3	360	710
	JC8118	250	2	520	880	250	2	400	880	250	2	320	710	250	2	250	560
		300	1.5	520	920	300	1.5	400	1,050	300	1.5	320	840	300	1.5	250	660
		350	1	440	1,150	350	1	350	910	350	1	270	710	350	1	220	580
400	0.5	410	1,260	400	0.5	350	1,340	400	0.5	270	1,040	400	0.5	220	850		
Stainless steel (SUS304) below 250HB	JC8050	150	4	610	850	150	4	480	830	150	4	390	680	150	4	300	520
	JC8015	200	3	610	960	200	3	480	940	200	3	390	770	200	3	300	590
	JC8118	250	2	430	750	250	2	340	740	250	2	270	590	250	2	210	460
		300	1.5	430	900	300	1.5	340	880	300	1.5	270	710	300	1.5	210	550
		350	1	370	750	350	1	280	710	350	1	230	590	350	1	180	460
400	0.5	340	1,040	400	0.5	280	1,070	400	0.5	230	880	400	0.5	180	690		
Hardened die steel (SKD61, DAC, DHA) 40-50HRC	JC8015 *without chipbreaker	100	2	510	560	100	2	390	530	100	2	310	430	100	2	240	330
	(DH103 over 50HRC)	150	1.8	510	590	150	1.8	390	560	150	1.8	310	450	150	1.8	240	350
		200	1.6	360	450	200	1.6	270	420	200	1.6	220	350	200	1.6	170	270
		250	1.2	360	470	250	1.2	270	430	250	1.2	220	360	250	1.2	170	280
		300	0.8	310	480	300	0.8	230	440	300	0.8	180	350	300	0.8	150	290
350	0.4	280	450	350	0.4	230	460	350	0.4	180	370	350	0.4	150	310		
Grey & Nodular cast iron (FC, FCD) below 300HB	JC8015	150	4	700	1,170	150	4	550	1,150	150	4	440	920	150	4	340	710
	JC8118	200	3	700	1,270	200	3	550	1,240	200	3	440	1,000	200	3	340	770
	JC8118	250	2	490	1,080	250	2	380	1,040	250	2	310	850	250	2	240	660
		300	1.5	490	1,210	300	1.5	380	1,170	300	1.5	310	960	300	1.5	240	740
		350	1	420	1,100	350	1	330	1,080	350	1	260	850	350	1	200	660
400	0.5	390	1,200	400	0.5	330	1,260	400	0.5	260	1,000	400	0.5	200	770		
Titanium alloy 35-43HRC	JC8050	150	1.5	260	310	150	1.5	200	300	150	1.5	150	260	150	1.5	120	180
	JC8015	200	1.3	260	240	200	1.3	200	230	200	1.3	150	170	200	1.3	120	140
	JC8118	250	1.1	180	200	250	1.1	140	200	250	1.1	100	140	250	1.1	85	120
		300	0.9	180	230	300	0.9	140	220	300	0.9	100	160	300	0.9	85	135
		350	0.6	160	260	350	0.6	120	240	350	0.6	90	180	350	0.6	70	140
400	0.3	140	300	400	0.3	120	320	400	0.3	90	240	400	0.3	70	190		
Heat resistant alloy 35-43HRC	JC8015	150	1.5	130	150	150	1.5	100	150	150	1.5	80	120	150	1.5	60	90
	JC8118	200	1.3	130	140	200	1.3	100	130	200	1.3	80	110	200	1.3	60	80
	JC8050	250	1.1	90	110	250	1.1	70	100	250	1.1	55	85	250	1.1	40	60
		300	0.9	90	100	300	0.9	70	100	300	0.9	55	80	300	0.9	40	55
		350	0.6	80	125	350	0.6	60	120	350	0.6	50	100	350	0.6	35	70
400	0.3	70	150	400	0.3	60	160	400	0.3	50	130	400	0.3	35	90		
Aluminium alloy (A5052, A7075) below 50-110HB	FZ05	150	6	2,800	5,300	150	6	2,400	5,600	150	6	1,900	5,900	150	6	1,500	5,250
		200	5	2,800	5,500	200	5	2,400	5,900	200	5	1,900	6,200	200	5	1,500	5,500
		250	4	2,350	4,800	250	4	2,050	5,300	250	4	1,650	5,600	250	4	1,300	5,000
		300	3	2,000	4,900	300	3	1,900	5,900	300	3	1,500	6,200	300	3	1,200	5,600
		350	2	1,900	4,100	350	2	1,750	4,700	350	2	1,400	5,000	350	2	1,100	4,400
400	1	1,600	3,100	400	1	1,600	3,800	400	1	1,250	4,000	400	1	1,000	3,600		

Note 1. In case of cutting hard materials (50-55HRC), reduce ap, n, Vf by 30% from standard conditions table.
 2. Wet cutting is recommended when machining Titanium, Inconel. 3. Use air blow

SUPER DIEMASTER

HDM/SDH Type

■ Recommended cutting conditions

● Facemill type / Fine pitch

Material	Grade	Tool dia.(mm)											
		50/52 (R6)				50/52 (R8)				63/66 (R6)			
		5N				4N				6N			
		φ (mm)	ap (mm)	n (min ⁻¹)	Vf (mm/min)	φ (mm)	ap (mm)	n (min ⁻¹)	Vf (mm/min)	φ (mm)	ap (mm)	n (min ⁻¹)	Vf (mm/min)
Carbon steel (S50C, S55C) below 250HB	JC8050	150	2	1,290	2,250	150	3	1,300	1,700	150	2	1,010	2,000
	JC5040	200	1.7	1,290	1,920	200	2.5	1,300	1,820	200	1.8	1,010	1,800
	JC8118	250	1.5	900	1,620	250	2	910	1,350	250	1.6	710	1,530
		300	1	900	2,020	300	1.2	910	1,800	300	1.2	710	1,910
		350	0.5	780	2,150	350	0.7	780	1,870	350	0.8	610	1,830
		400	-	-	-	400	-	-	-	400	0.4	560	1,850
Mold steel (HPM7, PX5, NAK80, P20) 30-43HRC	JC8050	150	1.7	1,230	2,200	150	2.5	1,250	1,750	150	1.7	960	2,060
	JC8118	200	1.5	1,230	2,150	200	2	1,250	1,850	200	1.6	960	2,130
	JC8015 (over 40HRC)	250	1.2	860	1,720	250	1.1	880	1,760	250	1.4	670	1,610
		300	0.8	860	1,720	300	0.9	880	1,760	300	1	670	1,810
		350	0.4	730	1,800	350	0.5	750	1,800	350	0.6	570	2,200
		400	-	-	-	400	-	-	-	400	0.4	550	2,150
Tool & die steel (SKD61, SKD11) below 255HB	JC5040	150	1.7	1,230	2,200	150	2.5	1,260	1,750	150	1.7	960	2,060
	JC8118	200	1.5	1,230	2,150	200	2	1,260	1,850	200	1.6	960	2,130
		250	1.2	860	1,720	250	1.1	880	1,760	250	1.4	670	1,610
		300	0.8	860	1,720	300	0.9	880	1,760	300	1	670	1,850
		350	0.4	730	1,800	350	0.5	750	1,850	350	0.6	570	2,200
		400	-	-	-	400	-	-	-	400	0.4	550	2,150
Stainless steel (SUS304) below 250HB	JC8050	150	2	1,020	1,780	150	3	1,030	1,350	150	2	800	1,670
	JC8015	200	1.7	1,020	1,520	200	2.5	1,030	1,440	200	1.8	800	1,770
	JC8118	250	1.5	710	1,240	250	2	720	1,060	250	1.6	560	1,180
		300	1	710	1,420	300	1.2	720	1,420	300	1.2	560	1,340
		350	0.5	610	1,530	350	0.7	620	1,490	350	0.8	480	1,380
		400	-	-	-	400	-	-	-	400	0.4	440	1,580
Hardened die steel (SKD61, DAC, DHA) 40-50HRC	JC8015 *without chipbreaker (DH103 over 50HRC)	100	1.2	850	1,060	100	1.5	880	880	100	1.2	650	970
	JC8015 *without chipbreaker (DH103 over 50HRC)	150	1	850	1,100	150	1.2	880	950	150	1.1	650	1,010
		200	0.8	560	980	200	1	620	740	200	0.9	460	970
		250	0.5	560	1,260	250	0.8	620	870	250	0.6	460	1,250
		300	0.3	510	1,270	300	0.4	530	850	300	0.4	390	1,170
		350	-	-	-	350	-	-	-	350	0.2	360	1,300
Grey & Nodular cast iron (FC, FCD) below 300HB	JC8015	150	2	1,150	2,350	150	3	1,170	1,820	150	2	900	2,260
	JC8118	200	1.7	1,150	2,580	200	2.5	1,170	2,000	200	1.8	900	2,420
		250	1.5	800	1,840	250	2	820	1,470	250	1.6	630	1,700
		300	1	800	2,300	300	1.2	820	1,800	300	1.2	630	1,920
		350	0.5	690	2,410	350	0.7	700	1,680	350	0.8	540	1,610
		400	-	-	-	400	-	-	-	400	0.4	500	1,730
Titanium alloy 35-43HRC	JC8050	150	1	420	420	150	1.5	440	440	150	1	330	400
	JC8015 JC8118	200	0.8	420	630	200	1.2	440	410	200	0.9	330	460
		250	0.6	290	460	250	1	310	310	250	0.7	230	370
		300	0.4	290	580	300	0.8	310	370	300	0.5	230	460
		350	0.2	250	630	350	0.4	260	420	350	0.3	200	540
		400	-	-	-	400	-	-	-	400	0.2	180	560
Heat resistant alloy 35-43HRC	JC8015	150	1	210	210	150	1.5	220	220	150	1	165	200
	JC8118 JC8050	200	0.8	210	320	200	1.2	220	210	200	0.9	165	230
		250	0.6	150	230	250	1	150	160	250	0.7	120	190
		300	0.4	150	290	300	0.8	150	190	300	0.5	120	230
		350	0.2	130	320	350	0.4	130	210	350	0.3	100	270
		400	-	-	-	400	-	-	-	400	0.2	90	280
Aluminium alloy (A5052, A7075) below 50-110HB	FZ05	150	4	4,300	8,400	150	5.5	4,300	6,700	150	4	3,350	7,800
		200	3.5	4,300	8,800	200	4.5	4,300	7,000	200	3.5	3,350	8,200
		250	3	3,650	7,800	250	3.5	3,650	6,300	250	3	2,900	7,400
		300	2	3,050	8,900	300	2.5	3,050	6,300	300	2	2,400	7,500
		350	1	2,950	6,600	350	1.5	2,950	5,300	350	1	2,300	7,200
		400	0.7	2,450	4,300	400	1	2,450	3,400	400	0.7	2,150	5,200

Note 1. In case of cutting hard materials (50-55HRC), reduce ap, n, Vf by 30% from standard conditions table.
 2. Wet cutting is recommended when machining Titanium, Inconel. 3. Use air blow

SUPER DIEMASTER **HDM/SDH Type**

- Recommended cutting conditions
- Facemill type / Fine pitch

Material	Grade	Tool dia. (mm)											
		63/66 (R8)				80 (R 6)				80 (R 8)			
		5N				7N				6N			
		φ (mm)	ap (mm)	n (min ⁻¹)	Vf (mm/min)	φ (mm)	ap (mm)	n (min ⁻¹)	Vf (mm/min)	φ (mm)	ap (mm)	n (min ⁻¹)	Vf (mm/min)
Carbon steel (S50C, S55C) below 250HB	JC8050	150	3	1,020	1,660	150	2	790	1,830	150	3	790	1,540
	JC5040	200	2.7	1,020	1,530	200	1.8	790	1,640	200	2.7	790	1,320
	JC8118	250	2.2	720	1,330	250	1.6	550	1,380	250	2.2	550	1,220
		300	1.6	720	1,450	300	1.2	550	1,730	300	1.6	550	1,330
		350	1	620	1,550	350	0.8	470	1,650	350	1	470	1,410
		400	0.5	560	1,800	400	0.4	430	1,660	400	0.5	430	1,660
Mold steel (HPM7, PX5, NAK80, P20) 30-43HRC	JC8050	150	2.5	970	1,690	150	1.7	740	1,850	150	2.5	750	1,570
	JC8118	200	2.2	970	1,790	200	1.6	740	1,920	200	2.2	750	1,660
	JC8015 (over 40HRC)	250	1.6	680	1,460	250	1.4	520	1,460	250	1.6	530	1,370
		300	1.1	680	1,800	300	1	520	1,640	300	1.1	530	1,680
		350	0.7	580	1,590	350	0.6	440	1,980	350	0.7	450	1,480
		400	0.5	560	1,680	400	0.4	410	1,870	400	0.5	410	1,480
Tool & die steel (SKD61, SKD11) below 255HB	JC5040	150	2.5	970	1,690	150	1.7	740	1,850	150	2.5	750	1,570
	JC8118	200	2.2	970	1,790	200	1.6	740	1,920	200	2.2	750	1,660
		250	1.6	680	1,460	250	1.4	520	1,460	250	1.6	530	1,370
		300	1.1	680	1,800	300	1	520	1,680	300	1.1	530	1,680
		350	0.7	580	1,590	350	0.6	440	1,980	350	0.7	450	1,480
		400	0.5	560	1,680	400	0.4	410	1,870	400	0.5	410	1,480
Stainless steel (SUS304) below 250HB	JC8050	150	3	810	1,320	150	2	620	1,510	150	3	620	1,210
	JC8015	200	2.7	810	1,330	200	1.8	620	1,600	200	2.7	620	1,220
	JC8118	250	2.2	570	1,050	250	1.6	430	1,060	250	2.2	430	950
		300	1.6	570	1,220	300	1.2	430	1,200	300	1.6	430	1,100
		350	1	490	1,230	350	0.8	370	1,240	350	1	370	1,110
		400	0.5	450	1,420	400	0.4	340	1,420	400	0.5	340	1,290
Hardened die steel (SKD61, DAC, DHA) 40-50HRC	JC8015 *without chipbreaker	100	1.5	670	840	100	1.2	500	870	100	1.5	500	750
	(DH103 over 50HRC)	150	1.2	670	900	150	1.1	500	910	150	1.2	500	810
		200	1	460	760	200	0.9	350	860	200	1	350	690
		250	0.8	460	920	250	0.6	350	1,110	250	0.8	350	840
		300	0.6	400	900	300	0.4	300	1,050	300	0.6	300	810
		350	0.3	360	900	350	0.2	270	1,140	350	0.3	270	810
Grey & Nodular cast iron (FC, FCD) below 300HB	JC8015	150	3	910	1,540	150	2	700	2,050	150	3	710	1,440
	JC8118	200	2.7	910	1,860	200	1.8	700	2,200	200	2.7	710	1,740
		250	2.2	640	1,440	250	1.6	490	1,540	250	2.2	500	1,350
		300	1.6	640	1,700	300	1.2	490	1,740	300	1.6	500	1,590
		350	1	550	1,510	350	0.8	420	1,460	350	1	430	1,420
		400	0.5	510	1,630	400	0.4	380	1,530	400	0.5	390	1,500
Titanium alloy 35-43HRC	JC8050	150	1.5	340	430	150	1	250	350	150	1.5	250	380
	JC8015	200	1.3	340	470	200	0.9	250	410	200	1.3	250	420
	JC8118	250	1.1	240	390	250	0.7	170	320	250	1.1	180	350
		300	0.9	240	400	300	0.5	170	400	300	0.9	180	360
		350	0.6	200	350	350	0.3	150	470	350	0.6	150	320
		400	0.3	180	490	400	0.2	140	510	400	0.3	140	460
Heat resistant alloy 35-43HRC	JC8015	150	1.5	170	220	150	1	120	170	150	1.5	125	190
	JC8118	200	1.3	170	240	200	0.9	120	200	200	1.3	125	210
	JC8050	250	1.1	120	200	250	0.7	80	150	250	1.1	90	180
		300	0.9	120	200	300	0.5	80	180	300	0.9	90	180
		350	0.6	100	180	350	0.3	70	220	350	0.6	75	160
		400	0.3	90	250	400	0.2	65	240	400	0.3	70	230
Aluminium alloy (A5052, A7075) below 50-110HB	FZ05	150	5.5	3,350	6,500	150	4	2,800	7,600	150	5.5	2,800	6,500
		200	4.5	3,350	6,800	200	3.5	2,800	8,000	200	4.5	2,800	6,900
		250	3.5	2,900	6,200	250	3	2,400	7,200	250	3.5	2,400	6,200
		300	2.5	2,400	6,200	300	2	2,000	7,300	300	2.5	2,000	6,200
		350	1.5	2,300	5,200	350	1	1,900	6,000	350	1.5	1,900	5,100
		400	1	2,150	4,300	400	0.7	1,600	4,500	400	1	1,600	3,800

Note 1. In case of cutting hard materials (50-55HRC), reduce ap, n, Vf by 30% from standard conditions table.
 2. Wet cutting is recommended when machining Titanium, Inconel. 3. Use air blow

SUPER DIEMASTER**HDM/SDH Type**

■ Recommended cutting conditions

● Facemill type / Fine pitch **HIGH SPEED CUTTING**

Material	Grade	Tool dia.(mm)											
		50/52 (R6)				50/52 (R8)				63/66 (R6)			
		5N				4N				6N			
		ℓ (mm)	a _p (mm)	n (min ⁻¹)	V _f (mm/min)	ℓ (mm)	a _p (mm)	n (min ⁻¹)	V _f (mm/min)	ℓ (mm)	a _p (mm)	n (min ⁻¹)	V _f (mm/min)
Carbon steel (S50C, S55C) below 250HB		150	1.4	1,590	3,180	150	1.9	1,640	2,400	150	1.4	1,240	2,980
		200	1.2	1,590	3,180	200	1.7	1,640	2,400	200	1.2	1,240	2,980
		250	1	1,110	2,220	250	1.3	1,150	1,680	250	1	870	2,090
		300	0.6	1,030	2,830	300	1	1,070	1,710	300	0.6	800	2,200
		350	0.3	950	2,610	350	0.4	980	2,350	350	0.3	740	2,040
		400	-	-	-	400	-	-	-	400	-	-	-
Mold steel (HPM7, PX5, NAK80, P20) 30-43HRC	JC8015	150	1.4	1,520	3,040	150	1.9	1,570	2,300	150	1.4	1,190	2,850
		200	1.2	1,520	3,040	200	1.7	1,570	2,300	200	1.2	1,190	2,850
		250	1	1,060	2,120	250	1.3	1,100	1,600	250	1	830	1,990
		300	0.6	990	2,720	300	1	1,020	1,630	300	0.6	770	2,220
		350	0.3	910	2,500	350	0.4	940	2,250	350	0.3	710	1,950
		400	-	-	-	400	-	-	-	400	-	-	-
Tool & die steel (SKD61, SKD11) below 255HB	*without chipbreaker	150	1.4	1,520	3,040	150	1.9	1,570	2,300	150	1.4	1,190	2,850
		200	1.2	1,520	3,040	200	1.7	1,570	2,300	200	1.2	1,190	2,850
		250	1	1,060	2,120	250	1.3	1,100	1,600	250	1	830	1,990
		300	0.6	990	2,720	300	1	1,020	1,630	300	0.6	770	2,120
		350	0.3	910	2,500	350	0.4	940	2,250	350	0.3	710	1,950
		400	-	-	-	400	-	-	-	400	-	-	-
Stainless steel (SUS304) below 250HB		150	1.4	1,320	2,640	150	1.9	1,360	2,000	150	1.4	1,030	2,470
		200	1.2	1,320	2,640	200	1.7	1,360	2,000	200	1.2	1,030	2,470
		250	1	920	1,840	250	1.3	950	1,390	250	1	720	1,730
		300	0.6	860	2,360	300	1	880	1,400	300	0.6	670	1,840
		350	0.3	790	2,170	350	0.4	820	1,970	350	0.3	620	1,700
		400	-	-	-	400	-	-	-	400	-	-	-
Hardened die steel (SKD61, DAC, DHA) 40-50HRC	DH103	100	1	1,070	1,870	100	1.2	1,100	1,540	100	1	830	1,710
		150	0.8	1,070	1,870	150	1	1,100	1,540	150	0.8	830	1,710
		200	0.6	750	3,740	200	0.8	770	1,120	200	0.6	580	1,390
		250	0.3	700	2,100	250	0.5	710	1,700	250	0.3	540	1,620
		300	0.2	640	2,170	300	0.3	660	1,650	300	0.2	500	1,980
		350	-	-	-	350	-	-	-	350	-	-	-
Grey & Nodular cast iron (FC, FCD) below 300HB		150	1.4	1,450	3,980	150	1.9	1,600	3,000	150	1.4	1,130	3,660
		200	1.2	1,450	3,980	200	1.7	1,500	3,000	200	1.2	1,130	3,660
		250	1	1,010	2,020	250	1.3	1,050	1,500	250	1	790	1,900
		300	0.6	940	3,520	300	1	970	2,700	300	0.6	730	2,400
		350	0.3	870	3,260	350	0.4	900	2,880	350	0.3	680	2,150
		400	-	-	-	400	-	-	-	400	-	-	-
Aluminium alloy (A5052, A7075) below 50-110HB	FZ05	150	1.6	5,500	15,000	150	2.1	5,500	12,000	150	1.6	4,300	14,000
		200	1.4	5,500	15,000	200	1.9	5,500	12,000	200	1.4	4,300	14,000
		250	1.2	4,900	17,000	250	1.5	4,900	13,600	250	1.2	3,850	16,000
		300	0.8	4,300	15,000	300	1.2	4,300	12,000	300	0.8	3,350	14,000
		350	0.6	4,000	14,000	350	0.6	4,000	11,200	350	0.6	3,150	13,000
		400	0.4	3,650	13,000	400	0.4	3,650	10,400	400	0.4	2,900	13,000

Note

1. Please adjust cutting conditions according to machine rigidity or work rigidity.
2. In case of chatter occurring, recommended to reduce a_p or V_f.
3. a_p should be reduced when using on low rigidity machine.
4. Use air blow.
5. In case of cutting hard materials (50-55HRC), reduce a_p, n, V_f by 30% from standard conditions table.

SUPER DIEMASTER**HDM/SDH Type**
■ Recommended cutting conditions

● Facemill type / Fine pitch **HIGH SPEED CUTTING**

Material	Grade	Tool dia.(mm)											
		63/66 (R8)				80 (R6)				80 (R8)			
		5N				7N				6N			
		ℓ (mm)	a _p (mm)	n (min ⁻¹)	V _f (mm/min)	ℓ (mm)	a _p (mm)	n (min ⁻¹)	V _f (mm/min)	ℓ (mm)	a _p (mm)	n (min ⁻¹)	V _f (mm/min)
Carbon steel (S50C, S55C) below 250HB		150	1.9	1,270	2,350	150	1.4	970	2,720	150	1.9	980	2,180
		200	1.7	1,270	2,350	200	1.2	970	2,720	200	1.7	980	2,180
		250	1.3	890	1,650	250	1	680	1,900	250	1.3	690	1,530
		300	1	830	1,600	300	0.6	630	2,030	300	1	640	1,490
		350	0.4	760	2,280	350	0.3	580	1,870	350	0.4	590	2,120
		400	-	-	-	400	-	-	-	400	-	-	-
Mold steel (HPM7, PX5, NAK80, P20) 30-43HRC	JC8015 *without chipbreaker	150	1.9	1,220	2,250	150	1.4	920	2,580	150	1.9	940	2,090
		200	1.7	1,220	2,250	200	1.2	920	2,580	200	1.7	940	2,090
		250	1.3	850	1,570	250	1	640	1,790	250	1.3	660	1,470
		300	1	790	1,580	300	0.6	600	1,930	300	1	610	1,460
		350	0.4	730	2,200	350	0.3	550	1,770	350	0.4	560	2,030
		400	-	-	-	400	-	-	-	400	-	-	-
Tool & die steel (SKD61, SKD11) below 255HB	JC8015 *without chipbreaker	150	1.9	1,220	2,250	150	1.4	920	2,580	150	1.9	940	2,090
		200	1.7	1,220	2,250	200	1.2	920	2,580	200	1.7	940	2,090
		250	1.3	850	1,570	250	1	640	1,790	250	1.3	660	1,470
		300	1	790	1,580	300	0.6	600	1,930	300	1	610	1,460
		350	0.4	730	2,200	350	0.3	550	1,770	350	0.4	560	2,030
		400	-	-	-	400	-	-	-	400	-	-	-
Stainless steel (SUS304) below 250HB	JC8015 *without chipbreaker	150	1.9	1,050	1,940	150	1.4	800	2,240	150	1.9	810	1,800
		200	1.7	1,050	1,940	200	1.2	800	2,240	200	1.7	810	1,800
		250	1.3	730	1,440	250	1	560	1,570	250	1.3	570	1,370
		300	1	680	1,360	300	0.6	520	1,680	300	1	530	1,270
		350	0.4	630	1,890	350	0.3	480	1,550	350	0.4	490	1,760
		400	-	-	-	400	-	-	-	400	-	-	-
Hardened die steel (SKD61, DAC, DHA) 40-50HRC	DH103	100	1.2	840	1,470	100	1	640	1,540	100	1.2	660	1,390
		150	1	840	1,470	150	0.8	640	1,540	150	1	660	1,390
		200	0.8	590	1,090	200	0.6	450	1,260	200	0.8	460	1,020
		250	0.5	550	1,320	250	0.3	420	1,470	250	0.5	430	1,240
		300	0.3	510	1,270	300	0.2	380	1,750	300	0.3	400	1,200
		350	-	-	-	350	-	-	-	350	-	-	-
Grey & Nodular cast iron (FC, FCD) below 300HB	DH103	150	1.9	1,160	2,900	150	1.4	880	3,320	150	1.9	900	2,700
		200	1.7	1,160	2,900	200	1.2	880	3,320	200	1.7	900	2,700
		250	1.3	810	1,930	250	1	620	1,740	250	1.3	630	1,800
		300	1	750	2,600	300	0.6	570	2,180	300	1	590	2,480
		350	0.4	700	2,800	350	0.3	530	1,950	350	0.4	540	2,590
		400	-	-	-	400	-	-	-	400	-	-	-
Aluminium alloy (A5052, A7075) below 50-110HB	FZ05	150	2.1	4,300	11,800	150	1.6	3,600	13,800	150	2.1	3,600	11,900
		200	1.9	4,300	11,800	200	1.4	3,600	13,800	200	1.9	3,600	11,900
		250	1.5	3,850	13,500	250	1.2	3,200	15,600	250	1.5	3,200	13,400
		300	1.2	3,350	11,700	300	0.8	2,800	13,700	300	1.2	2,800	11,750
		350	0.6	3,150	11,000	350	0.6	2,600	12,700	350	0.6	2,600	11,000
		400	0.4	2,900	11,000	400	0.4	2,400	12,600	400	0.4	2,400	10,800

Note

1. Please adjust cutting conditions according to machine rigidity or work rigidity.
2. In case of chatter occurring, recommended to reduce a_p or V_f.
3. a_p should be reduced when using on low rigidity machine.
4. Use air blow.
5. In case of cutting hard materials (50-55HRC), reduce a_p, n, V_f by 30% from standard conditions table.

SUPER DIEMASTER
HDM/SDH Type
■ Recommended cutting conditions
● Modular head SDH type

Material	Grade	Tool dia.(mm)							
		15/16 (R3.5)				20/22 (R3.5)			
		2N				2N			
		ℓ (mm)	a_p (mm)	n (min ⁻¹)	V_f (mm/min)	ℓ (mm)	a_p (mm)	n (min ⁻¹)	V_f (mm/min)
Carbon steel (S50C, S55C) below 250HB	JC8050	70	1.4	3,500	1,650	70	1.5	2,900	1,450
	JC5040	120	1.1	3,500	1,650	120	1.2	2,900	1,450
	JC8118	160	0.6	3,300	1,500	160	0.7	2,800	1,350
Mold steel (HPM7, PX5, NAK80, P20) 30-43HRC	JC8050	70	1.4	3,300	1,550	70	1.5	2,800	1,400
	JC8118	120	1.1	3,300	1,550	120	1.2	2,800	1,400
	JC8015 (over 40HRC)	160	0.6	3,200	1,500	160	0.7	2,700	1,350
Tool & die steel (SKD61, SKD11) below 255HB	JC5040	70	1.4	3,300	1,550	70	1.5	2,800	1,400
	JC8118	120	1.1	3,300	1,550	120	1.2	2,800	1,400
		160	0.6	3,200	1,500	160	0.7	2,700	1,350
Stainless steel (SUS304) below 250HB	JC8050	70	1.4	2,700	1,300	70	1.5	2,300	1,200
	JC8015	120	1.1	2,700	1,300	120	1.2	2,300	1,200
	JC8118	160	0.6	2,600	1,250	160	0.7	2,200	1,100
Hardened die steel (SKD61, DAC, DHA) 40-50HRC	JC8015 *without chipbreaker DH103 (over 50HRC)	70	0.7	2,400	1,150	70	0.8	2,000	1,000
		120	0.5	2,400	1,150	120	0.6	2,000	1,000
		160	0.3	2,200	1,050	160	0.3	1,900	950
Grey & Nodular cast iron (FC, FCD) below 300HB	JC8015	70	1.4	3,100	1,550	70	1.5	2,600	1,400
	JC8118	120	1.1	3,100	1,550	120	1.2	2,600	1,400
		160	0.6	3,000	1,400	160	0.7	2,500	1,300
Titanium alloy 35-43HRC	JC8050	70	0.5	1,200	600	70	0.5	1,000	500
	JC8015	120	0.4	1,200	600	120	0.4	1,000	500
	JC8118	160	0.2	1,100	490	160	0.2	980	440
Heat resistant alloy 35-43HRC	JC8015	70	0.5	620	190	70	0.5	510	160
	JC8118	120	0.4	560	190	120	0.4	470	160
	JC8050	160	0.2	520	190	160	0.2	440	160
Aluminium alloy below 50-110HB	FZ05	70	2	8,600	4,800	70	2	7,200	4,300
		120	1.7	8,600	4,800	120	1.7	7,200	4,300
		160	1.2	7,000	4,900	160	1.2	5,800	4,300

Note

1. Please adjust cutting conditions according to machine rigidity or work rigidity.
2. In case of chatter occurring, recommended to reduce a_p or V_f .
3. a_p should be reduced when using on low rigidity machine.
4. Use air blow.
5. In case of cutting hard materials (50-55HRC), reduce a_p , n , V_f by 30% from standard conditions table.
6. Wet cutting is recommended when machining Titanium, Inconel.

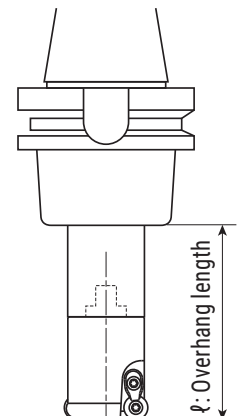

SUPER DIEMASTER**HDM/SDH Type**

■ Recommended cutting conditions

● Modular head SDH type

Material	Grade	Tool dia.(mm)							
		20/22 (R3.5)				25/28 (R5)			
		3N				2N			
		ℓ (mm)	a_p (mm)	n (min ⁻¹)	V_f (mm/min)	ℓ (mm)	a_p (mm)	n (min ⁻¹)	V_f (mm/min)
Carbon steel (S50C, S55C) below 250HB	JC8050	70	1.2	3,500	2,900	90	2	2,400	1,400
	JC5040	120	0.8	3,500	2,900	140	1.5	2,400	1,400
	JC8118	160	0.5	3,200	2,700	210	1	2,300	1,300
Mold steel (HPM7, PX5, NAK80, P20) 30-43HRC	JC8050	70	1.2	3,300	2,600	90	2	2,200	1,300
	JC8118	120	0.8	3,300	2,600	140	1.5	2,200	1,300
	JC8015 (over 40HRC)	160	0.5	3,100	2,300	210	1	2,100	1,200
Tool & die steel (SKD61, SKD11) below 255HB	JC5040	70	1.2	3,300	2,600	90	2	2,200	1,300
	JC8118	120	0.8	3,300	2,600	140	1.5	2,200	1,300
		160	0.5	3,100	2,300	210	1	2,100	1,200
Stainless steel (SUS304) below 250HB	JC8050	70	1.2	2,700	2,400	90	2	1,800	1,050
	JC8015	120	0.8	2,700	2,400	140	1.5	1,800	1,050
	JC8118	160	0.5	2,600	2,200	210	1	1,700	1,000
Hardened die steel (SKD61, DAC, DHA) 40-50HRC	JC8015 *without chipbreaker DH103 (over 50HRC)	70	0.7	2,500	2,000	90	1	1,600	1,000
		120	0.5	2,500	2,000	140	0.5	1,600	1,000
		160	0.3	2,200	1,800	210	0.3	1,500	950
Grey & Nodular cast iron (FC, FCD) below 300HB	JC8015	70	1.2	3,050	2,600	90	2	2,100	1,300
	JC8118	120	0.8	3,050	2,600	140	1.5	2,100	1,300
		160	0.5	2,900	2,400	210	1	1,200	1,200
Titanium alloy 35-43HRC	JC8050	70	0.5	1,000	750	90	0.5	780	460
	JC8015	120	0.4	1,000	750	140	0.4	780	460
	JC8118	160	0.2	980	660	210	0.2	750	410
Heat resistant alloy 35-43HRC	JC8015	70	0.5	510	240	90	0.5	430	170
	JC8118	120	0.4	470	240	140	0.4	390	140
	JC8050	160	0.2	440	240	210	0.2	370	140
Aluminium alloy below 50-110HB	FZ05	70	2	7,200	6,400	90	3.5	5,700	3,400
		120	1.7	7,200	6,400	140	2	5,700	3,400
		160	1.2	5,800	4,300	210	1.5	4,500	2,200

Note

1. Please adjust cutting conditions according to machine rigidity or work rigidity.
2. In case of chatter occurring, recommended to reduce a_p or V_f .
3. a_p should be reduced when using on low rigidity machine.
4. Use air blow.
5. In case of cutting hard materials (50-55HRC), reduce a_p , n , V_f by 30% from standard conditions table.
6. Wet cutting is recommended when machining Titanium, Inconel.

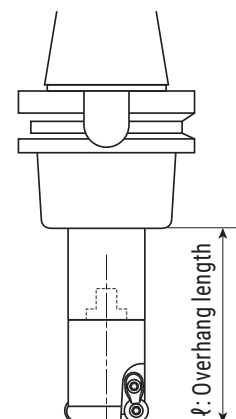

SUPER DIEMASTER
HDM/SDH Type
■ Recommended cutting conditions
● Modular head SDH type

Material	Grade	Tool dia.(mm)							
		25 (R3.5) /25 (R5) /28 (R5)				30 (R5) /32 (R6) /35 (R5)			
		3N				2N			
		ℓ (mm)	a_p (mm)	n (min ⁻¹)	V_f (mm/min)	ℓ (mm)	a_p (mm)	n (min ⁻¹)	V_f (mm/min)
Carbon steel (S50C, S55C) below 250HB	JC8050	90	1.5	2,800	2,100	100	2.5	2,000	1,100
	JC5040	140	1.2	2,800	2,100	150	2	2,000	1,100
	JC8118	210	0.7	2,600	1,900	210	1.2	1,900	1,000
Mold steel (HPM7, PX5, NAK80, P20) 30-43HRC	JC8050	90	1.5	2,600	2,000	100	2.5	1,900	1,050
	JC8118	140	1.2	2,600	2,000	150	2	1,900	1,050
	JC8015 (over 40HRC)	210	0.7	2,400	1,800	210	1.2	1,800	950
Tool & die steel (SKD61, SKD11) below 255HB	JC5040	90	1.5	2,500	1,600	100	2.5	1,900	1,050
	JC8118	140	1.2	2,500	1,600	150	2	1,900	1,050
		210	0.7	2,400	1,400	210	1.2	1,800	950
Stainless steel (SUS304) below 250HB	JC8050	90	1.5	2,100	1,400	100	2.5	1,550	850
	JC8015	140	1.2	2,100	1,400	150	2	1,550	850
	JC8118	210	0.7	2,000	1,000	210	1.2	1,400	800
Hardened die steel (SKD61, DAC, DHA) 40-50HRC	JC8015 *without chipbreaker DH103 (over 50HRC)	90	0.8	1,900	1,400	100	1.5	1,300	750
		140	0.6	1,900	1,400	150	1.2	1,300	750
		210	0.4	1,800	1,000	210	0.7	1,200	700
Grey & Nodular cast iron (FC, FCD) below 300HB	JC8015	90	1.2	2,500	2,200	100	2.5	1,800	1,000
	JC8118	140	0.8	2,500	2,200	150	2	1,800	1,000
		210	0.5	2,300	1,700	210	1.2	1,700	900
Titanium alloy 35-43HRC	JC8050	90	0.5	780	690	100	0.5	730	470
	JC8015	140	0.4	780	690	150	0.4	730	330
	JC8118	210	0.2	750	620	210	0.2	700	260
Heat resistant alloy 35-43HRC	JC8015	90	0.5	430	260	100	0.5	400	170
	JC8118	140	0.4	390	210	150	0.4	380	150
	JC8050	210	0.2	370	210	210	0.2	350	130
Aluminium alloy below 50-110HB	FZ05	90	2.2	5,700	5,100	100	3.5	4,500	2,700
		120	1.9	5,700	5,100	150	2	4,500	2,700
		160	1.5	4,500	5,100	210	1.5	3,600	1,800

Note

1. Please adjust cutting conditions according to machine rigidity or work rigidity.
2. In case of chatter occurring, recommended to reduce a_p or V_f .
3. a_p should be reduced when using on low rigidity machine.
4. Use air blow.
5. In case of cutting hard materials (50-55HRC), reduce a_p , n , V_f by 30% from standard conditions table.
6. Wet cutting is recommended when machining Titanium, Inconel.

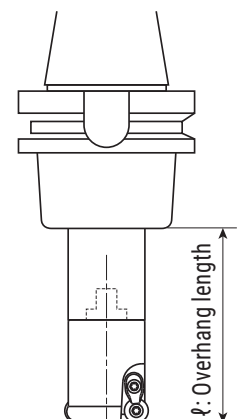

SUPER DIEMASTER**HDM/SDH Type**

■ Recommended cutting conditions

● Modular head SDH type

Material	Grade	Tool dia.(mm)							
		32/35 (R5)				30 (R5) /35 (R6)			
		3N				3N			
		ℓ (mm)	a_p (mm)	n (min ⁻¹)	V_f (mm/min)	ℓ (mm)	a_p (mm)	n (min ⁻¹)	V_f (mm/min)
Carbon steel (S50C, S55C) below 250HB	JC8050	100	2.5	2,000	1,600	100	2	2,100	1,900
	JC5040	150	2	2,000	1,600	150	1.5	2,100	1,900
	JC8118	210	1.2	1,900	1,400	210	0.8	2,000	1,600
Mold steel (HPM7, PX5, NAK80, P20) 30-43HRC	JC8050	100	2.5	1,900	1,550	100	2	2,000	1,800
	JC8118	150	2	1,900	1,550	150	1.5	2,000	1,800
	JC8015 (over 40HRC)	210	1.2	1,800	1,400	210	0.8	1,900	1,550
Tool & die steel (SKD61, SKD11) below 255HB	JC5040	100	2.5	1,900	1,550	100	2	2,000	1,800
	JC8118	150	2	1,900	1,550	150	1.5	2,000	1,800
		210	1.2	1,800	1,400	210	0.8	1,900	1,500
Stainless steel (SUS304) below 250HB	JC8050	100	2.5	1,550	1,250	100	2	1,750	1,500
	JC8015	150	2	1,550	1,250	150	1.5	1,750	1,500
	JC8118	210	1.2	1,400	1,200	210	0.8	1,600	1,300
Hardened die steel (SKD61, DAC, DHA) 40-50HRC	JC8015 *without chipbreaker DH103 (over 50HRC)	100	1.5	1,300	1,100	100	1.2	1,400	1,250
		150	1.2	1,300	1,100	150	1	1,400	1,250
		210	0.7	1,200	950	210	0.5	1,300	1,100
Grey & Nodular cast iron (FC, FCD) below 300HB	JC8015	100	2.5	1,800	1,500	100	2	1,900	1,700
	JC8118	150	2	1,800	1,500	150	1.5	1,900	1,700
		210	1.2	1,700	1,350	210	0.8	1,800	1,600
Titanium alloy 35-43HRC	JC8050	100	0.5	730	650	100	0.5	730	650
	JC8015	150	0.4	730	650	150	0.4	730	650
	JC8118	210	0.2	700	600	210	0.2	700	600
Heat resistant alloy 35-43HRC	JC8015	100	0.5	400	250	100	0.5	400	250
	JC8118	150	0.4	380	230	150	0.4	380	230
	JC8050	210	0.2	350	200	210	0.2	350	200
Aluminium alloy below 50-110HB	FZ05	100	3.5	4,500	4,100	100	3.5	4,500	4,100
		150	2	4,500	4,100	150	2	4,500	4,100
		210	1.5	3,600	2,700	210	1.5	3,600	2,700

Note

1. Please adjust cutting conditions according to machine rigidity or work rigidity.
2. In case of chatter occurring, recommended to reduce a_p or V_f .
3. a_p should be reduced when using on low rigidity machine.
4. Use air blow.
5. In case of cutting hard materials (50-55HRC), reduce a_p , n , V_f by 30% from standard conditions table.
6. Wet cutting is recommended when machining Titanium, Inconel.

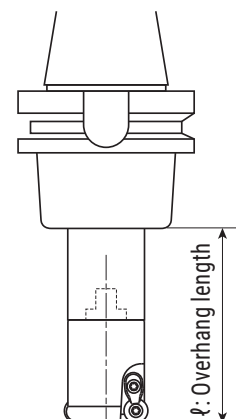

SUPER DIEMASTER
HDM/SDH Type
■ Recommended cutting conditions
● Modular head SDH type

Material	Grade	Tool dia.(mm)							
		30/32/35 (R5)				40 (R6)			
		4N				2N			
		ℓ (mm)	a_p (mm)	n (min ⁻¹)	V_f (mm/min)	ℓ (mm)	a_p (mm)	n (min ⁻¹)	V_f (mm/min)
Carbon steel (S50C, S55C) below 250HB	JC8050	100	2	2,100	2,500	100	2.5	1,550	890
	JC5040	150	1.5	2,100	2,500	150	2	1,550	890
	JC8118	210	0.8	2,000	2,400	210	1.2	1,450	780
Mold steel (HPM7, PX5, NAK80, P20) 30-43HRC	JC8050	100	2	2,000	2,400	100	2.5	1,500	840
	JC8118	150	1.5	2,000	2,400	150	2	1,500	840
	JC8015 (over 40HRC)	210	0.8	1,900	2,100	210	1.2	1,450	780
Tool & die steel (SKD61, SKD11) below 255HB	JC5040	100	2	2,000	2,400	100	2.5	1,500	840
	JC8118	150	1.5	2,000	2,400	150	2	1,500	840
		210	0.8	1,900	2,100	210	1.2	1,450	780
Stainless steel (SUS304) below 250HB	JC8050	100	2	1,750	2,000	100	2.5	1,250	700
	JC8015	150	1.5	1,750	2,000	150	2	1,250	700
	JC8118	210	0.8	1,600	1,700	210	1.2	1,200	670
Hardened die steel (SKD61, DAC, DHA) 40-50HRC	JC8015 *without chipbreaker DH103 (over 50HRC)	100	1.2	1,400	1,850	100	1.5	1,050	550
		150	1	1,400	1,850	150	1.2	1,050	550
		210	0.5	1,300	1,700	210	0.7	1,000	520
Grey & Nodular cast iron (FC, FCD) below 300HB	JC8015	100	2	1,900	2,250	100	2.5	1,400	800
	JC8118	150	1.5	1,900	2,250	150	2	1,400	800
		210	0.8	1,800	2,100	210	1.2	1,300	750
Titanium alloy 35-43HRC	JC8050	100	0.5	730	860	100	0.5	580	350
	JC8015	150	0.4	730	860	150	0.4	580	350
	JC8118	210	0.2	700	800	210	0.2	550	330
Heat resistant alloy 35-43HRC	JC8015	100	0.5	400	330	100	0.5	290	170
	JC8118	150	0.4	380	310	150	0.4	270	160
	JC8050	210	0.2	350	270	210	0.2	250	120
Aluminium alloy below 50-110HB	FZ05	100	3.5	4,500	5,400	100	4	4,000	2,400
		150	2	4,500	5,400	150	2.5	4,000	2,400
		210	1.5	3,600	3,600	210	2	3,200	1,600

Note

1. Please adjust cutting conditions according to machine rigidity or work rigidity.
2. In case of chatter occurring, recommended to reduce a_p or V_f .
3. a_p should be reduced when using on low rigidity machine.
4. Use air blow.
5. In case of cutting hard materials (50-55HRC), reduce a_p , n , V_f by 30% from standard conditions table.
6. Wet cutting is recommended when machining Titanium, Inconel.

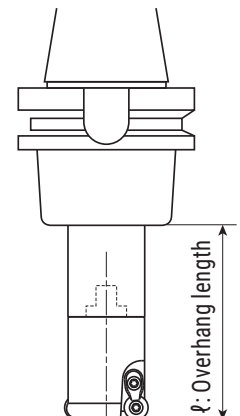

SUPER DIEMASTER**HDM/SDH Type**

■ Recommended cutting conditions

● Modular head SDH type

Material	Grade	Tool dia.(mm)							
		40 (R6)				42 (R5)			
		4N				5N			
		ℓ (mm)	a_p (mm)	n (min ⁻¹)	V_f (mm/min)	ℓ (mm)	a_p (mm)	n (min ⁻¹)	V_f (mm/min)
Carbon steel (S50C, S55C) below 250HB	JC8050	100	2	1,900	2,300	100	1.8	1,750	2,600
	JC5040	150	1.5	1,900	2,300	150	1.3	1,750	2,600
	JC8118	210	0.8	1,800	2,200	210	0.7	1,650	2,400
Mold steel (HPM7, PX5, NAK80, P20) 30-43HRC	JC8050	100	2	1,800	2,100	100	1.8	1,700	2,500
	JC8118	150	1.5	1,800	2,100	150	1.3	1,700	2,500
	JC8015 (over 40HRC)	210	0.8	1,700	2,000	210	0.7	1,600	2,200
Tool & die steel (SKD61, SKD11) below 255HB	JC5040	100	2	1,800	2,100	100	1.8	1,700	2,600
	JC8118	150	1.5	1,800	2,100	150	1.3	1,700	2,600
		210	0.8	1,700	2,000	210	0.7	1,600	2,400
Stainless steel (SUS304) below 250HB	JC8050	100	2	1,550	1,600	100	1.8	1,400	2,100
	JC8015	150	1.5	1,550	1,600	150	1.3	1,400	2,100
	JC8118	210	0.8	1,500	1,400	210	0.7	1,250	1,600
Hardened die steel (SKD61, DAC, DHA) 40-50HRC	JC8015 *without chipbreaker DH103 (over 50HRC)	100	1.2	1,350	1,350	100	1.1	1,250	1,500
		150	1	1,350	1,350	150	0.9	1,250	1,500
		210	0.5	1,300	1,100	210	0.4	1,150	1,300
Grey & Nodular cast iron (FC, FCD) below 300HB	JC8015	100	2	1,700	2,050	100	1.8	1,650	2,400
	JC8118	150	1.5	1,700	2,050	150	1.3	1,650	2,400
		210	0.8	1,600	1,800	210	0.7	1,550	2,200
Titanium alloy 35-43HRC	JC8050	100	0.5	580	700	100	0.5	610	730
	JC8015	150	0.4	580	700	150	0.4	610	730
	JC8118	210	0.2	550	660	210	0.2	580	690
Heat resistant alloy 35-43HRC	JC8015	100	0.5	290	340	100	0.5	300	310
	JC8118	150	0.4	270	320	150	0.4	280	290
	JC8050	210	0.2	250	240	210	0.2	260	250
Aluminium alloy below 50-110HB	FZ05	100	4	4,000	4,800	100	3.5	3,800	5,700
		150	2.5	4,000	4,800	150	2	3,800	5,700
		210	2	3,200	3,200	210	1.5	3,000	3,700

Note

1. Please adjust cutting conditions according to machine rigidity or work rigidity.
2. In case of chatter occurring, recommended to reduce a_p or V_f .
3. a_p should be reduced when using on low rigidity machine.
4. Use air blow.
5. In case of cutting hard materials (50-55HRC), reduce a_p , n , V_f by 30% from standard conditions table.
6. Wet cutting is recommended when machining Titanium, Inconel.

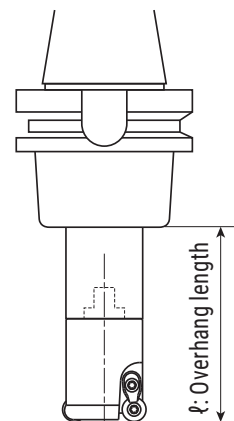

SUPER DIEMASTER

HDM/SDH Type

■ Recommended cutting conditions

● Modular head SDH type

HIGH SPEED CUTTING

Material	Grade	Tool dia.(mm)							
		20/22 (R3.5)				25 (R3.5) /25 (R5) /28 (R5)			
		3N				3N			
		ℓ (mm)	a_p (mm)	n (min ⁻¹)	V_f (mm/min)	ℓ (mm)	a_p (mm)	n (min ⁻¹)	V_f (mm/min)
Carbon steel (S50C, S55C) below 250HB		70	0.3	5,400	4,800	90	0.3	4,200	3,800
		120	0.2	5,100	4,300	140	0.2	4,000	3,400
		160	0.1	4,300	3,600	210	0.1	3,400	2,850
Mold steel (HPM7, PX5, NAK80, P20) 30-43HRC	JC8015	70	0.3	4,300	3,200	90	0.3	3,400	2,500
		120	0.2	4,100	2,900	140	0.2	3,200	2,250
		160	0.1	3,400	2,400	210	0.1	2,700	1,900
Tool & die steel (SKD61, SKD11) below 255HB	*without chipbreaker	70	0.3	4,300	3,200	90	0.3	3,400	2,500
		120	0.2	4,100	2,900	140	0.2	3,200	2,250
		160	0.1	3,400	2,400	210	0.1	2,700	1,900
Stainless steel (SUS304) below 250HB		70	0.3	3,600	3,200	90	0.3	2,800	2,500
		120	0.2	3,400	2,900	140	0.2	2,700	2,250
		160	0.1	2,900	2,400	210	0.1	2,250	1,900
Hardened die steel (SKD61, DAC, DHA) 40-50HRC	DH103	70	0.2	4,000	3,000	90	0.2	3,100	2,300
		120	0.12	3,700	2,600	140	0.12	3,000	2,100
		160	0.06	3,200	2,200	210	0.06	2,500	1,700
Grey & Nodular cast iron (FC, FCD) below 300HB		70	0.3	5,700	5,100	90	0.3	4,500	4,000
		120	0.2	5,100	4,600	140	0.2	4,300	3,600
		160	0.1	4,550	3,800	210	0.1	3,600	3,000
Aluminium alloy below 50-110HB	FZ05	70	1.5	10,100	12,000	90	1.7	8,000	9,600
		120	1.2	10,100	12,000	140	1.4	8,000	9,600
		160	0.7	8,700	7,800	210	1	6,800	6,100

Note

1. Please adjust cutting conditions according to machine rigidity or work rigidity.
2. In case of chatter occurring, recommended to reduce a_p or V_f .
3. a_p should be reduced when using on low rigidity machine.
4. Use air blow.
5. In case of cutting hard materials (50-55HRC), reduce a_p , n , V_f by 30% from standard conditions table.

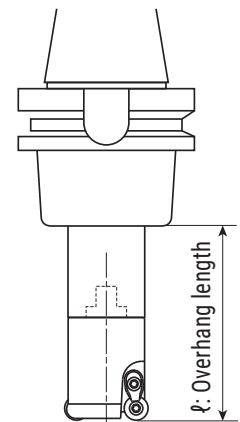

SUPER DIEMASTER**HDM/SDH Type**

■ Recommended cutting conditions

● Modular head SDH type

HIGH SPEED CUTTING

Material	Grade	Tool dia.(mm)							
		30 (R5) /35 (R6)				30/32/35 (R5)			
		3N				4N			
		ℓ (mm)	a_p (mm)	n (min ⁻¹)	V_f (mm/min)	ℓ (mm)	a_p (mm)	n (min ⁻¹)	V_f (mm/min)
Carbon steel (S50C, S55C) below 250HB		100	0.3	3,300	2,900	100	0.3	3,300	4,000
		150	0.2	3,100	2,800	150	0.2	3,100	3,600
		210	0.1	2,600	2,150	210	0.1	2,600	3,000
Mold steel (HPM7, PX5, NAK80, P20) 30-43HRC	JC8015	100	0.3	2,800	2,000	100	0.3	2,800	2,800
		150	0.2	2,700	1,800	150	0.2	2,700	2,500
		210	0.1	2,200	1,500	210	0.1	2,250	2,100
Tool & die steel (SKD61, SKD11) below 255HB	*without chipbreaker	100	0.3	2,800	2,000	100	0.3	2,800	2,800
		150	0.2	2,400	1,800	150	0.2	2,700	2,500
		210	0.1	2,200	1,500	210	0.1	2,250	2,100
Stainless steel (SUS304) below 250HB		100	0.3	2,300	2,000	100	0.3	2,300	2,700
		150	0.2	2,200	1,800	150	0.2	2,200	2,400
		210	0.1	1,850	1,500	210	0.1	1,850	2,000
Hardened die steel (SKD61, DAC, DHA) 40-50HRC	DH103	100	0.2	2,500	1,850	100	0.2	2,550	2,550
		150	0.15	2,450	1,650	150	0.15	2,400	2,250
		210	0.1	2,050	1,400	210	0.1	2,050	1,850
Grey & Nodular cast iron (FC, FCD) below 300HB		100	0.3	3,600	3,200	100	0.3	3,600	4,300
		150	0.2	3,400	2,900	150	0.2	3,400	3,900
		210	0.1	2,900	2,400	210	0.1	2,900	3,200
Aluminium alloy below 50-110HB	FZ05	100	2	6,400	7,700	100	2	6,400	10,200
		150	1.5	6,400	7,700	150	1.5	6,400	10,200
		210	1	5,500	5,000	210	1	5,500	6,600

Note

1. Please adjust cutting conditions according to machine rigidity or work rigidity.
2. In case of chatter occurring, recommended to reduce a_p or V_f .
3. a_p should be reduced when using on low rigidity machine.
4. Use air blow.
5. In case of cutting hard materials (50-55HRC), reduce a_p , n , V_f by 30% from standard conditions table.

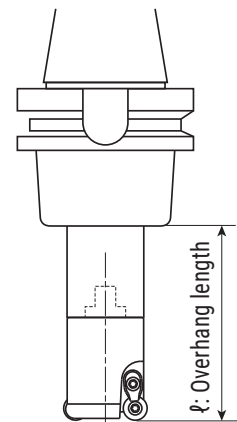

SUPER DIEMASTER
HDM/SDH Type
Recommended cutting conditions
Modular head SDH type
HIGH SPEED CUTTING

Material	Grade	Tool dia.(mm)							
		40 (R6)				42 (R5)			
		4N				5N			
		ℓ (mm)	a_p (mm)	n (min ⁻¹)	V_f (mm/min)	ℓ (mm)	a_p (mm)	n (min ⁻¹)	V_f (mm/min)
Carbon steel (S50C, S55C) below 250HB		100	0.3	2,900	3,400	100	0.3	2,800	4,200
		150	0.2	2,700	3,050	150	0.2	2,650	2,400
		210	0.1	2,300	2,550	210	0.1	2,250	3,150
Mold steel (HPM7, PX5, NAK80, P20) 30-43HRC	JC8015	100	0.3	2,400	2,400	100	0.3	2,300	2,800
		150	0.2	2,300	2,150	150	0.2	2,200	2,500
		210	0.1	1,900	1,800	210	0.1	1,850	2,100
Tool & die steel (SKD61, SKD11) below 255HB	*without chipbreaker	100	0.3	2,400	2,400	100	0.3	2,300	2,800
		150	0.2	2,300	2,150	150	0.2	2,200	2,500
		210	0.1	1,900	1,800	210	0.1	1,850	2,100
Stainless steel (SUS304) below 250HB		100	0.3	2,000	2,400	100	0.3	1,900	2,800
		150	0.2	1,900	2,150	150	0.2	1,800	2,500
		210	0.1	1,600	1,800	210	0.1	1,500	2,100
Hardened die steel (SKD61, DAC, DHA) 40-50HRC	DH103	100	0.2	2,200	2,200	100	0.2	2,100	2,500
		150	0.15	2,100	2,000	150	0.15	2,000	2,250
		210	0.1	1,750	1,650	210	0.1	1,650	1,850
Grey & Nodular cast iron (FC, FCD) below 300HB		100	0.3	3,200	4,000	100	0.3	3,000	3,600
		150	0.2	3,000	3,600	150	0.2	2,850	3,250
		210	0.1	2,550	3,000	210	0.1	2,400	2,700
Aluminium alloy below 50-110HB	FZ05	100	2.5	5,600	9,000	100	2	5,300	10,600
		150	2	5,600	9,000	150	1.5	5,300	10,600
		210	1.3	4,800	5,800	210	1	4,500	6,800

Note

1. Please adjust cutting conditions according to machine rigidity or work rigidity.
2. In case of chatter occurring, recommended to reduce a_p or V_f .
3. a_p should be reduced when using on low rigidity machine.
4. Use air blow.
5. In case of cutting hard materials (50-55HRC), reduce a_p , n , V_f by 30% from standard conditions table.

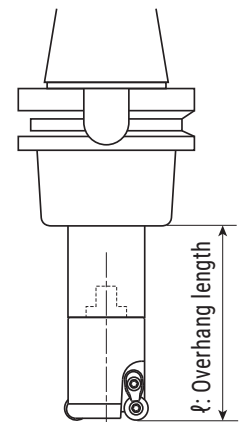

SUPER DIEMASTER **HDM/SDH Type**

■ **Insert grades**

ISO	P				M				K				N				S				H			
	P01	P10	P20	P30	P40	M01	M10	M20	M30	M40	K01	K10	K20	K30	N01	N10	N20	N30	S01	S10	S20	S30	H01	H10
Range	JC5040				JC8118				JC8015				FZ05				JC8118				JC8118			
	JC8118				JC8015				JC8015				JC8015				JC8118				DH103			
	JC8015				JC8050				JC8015				JC8015				JC8015				DH103			
	JC8015				JC8050				JC8015				JC8015				JC8050				DH103			

■ **Grade selection guide**

Material	Cast iron	Carbon steel · Tool steel			Mold steel		Hardened steel	Titanium alloy Inconel		Stainless steel		Aluminium		
		Grade	JC8015	JC5040	JC8118	JC8050		JC8015	JC8050	DH103 (over 50HRC)	JC8015		JC8050	JC8015
RDMW07T2MOT	◎	◎	○		◎		◎	○		○				
RD * T07T2MOE	☆		☆	●	☆	●		◎	●	◎	●			
RDMW1004MOT	◎	◎	○		◎		◎							
RD * T1004MOT	☆				○					○	●			
RD * T1004MOE			☆	●	☆	●		○	●	☆				
RDMT1004MOE-ML								◎			◎			
RDMW1204MOT	◎	◎	○		◎		◎							
RD * T1204MOT	☆				○					○	●			
RD * T1204MOE			☆	●	☆	●		○	●	☆				
RDMT1204MOE-ML								◎			◎			
RDMW1606MOT	◎	◎	○		◎		◎							
RD * T1606MOT	☆				○					○	●			
RD * T1606MOE			☆	●	☆	●		○	◎	☆	◎			
RDGT****MOF-AL												◎		

■ **Grade selection guide**

Material	Cast iron	Carbon steel Tool steel	Mold steel	Hardened steel	Stainless steel	Aluminium
Cat.No./Grade	DH103	JC8015	JC8015	DH103	JC8015	FZ05
RDMW****MOT	◎	◎	◎	◎	◎	
RDGT****MOF-AL						◎

• RDMW type : without chip breaker • RD*T type : with chip breaker
 ◎ : First choice ○ : General cutting ● : Unstable cutting ☆ : Light cutting

HEPTA MILL

HEP Type

HEPTA MILL- High Feed Mill with 7 Cutting-Edge



- Max. Depth of cut 5mm at fz=1mm/tooth is possible.
- Insert with thickness 6.35mm is durable for heavy roughing.
- Heptagonal insert with unique geometry for lower cutting force.
- Double clamping system
- Multi functional cutter for ramping , pocket milling , plunging.



Fig 1

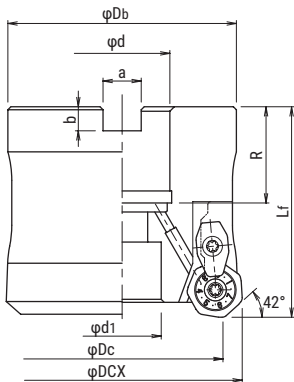

Fig 2

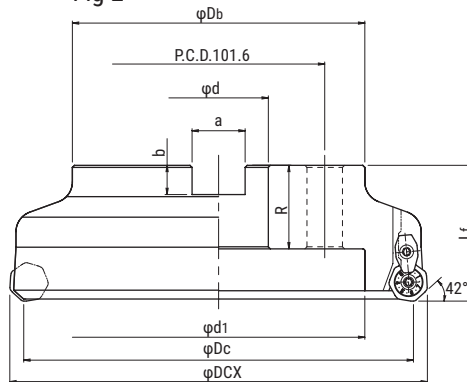
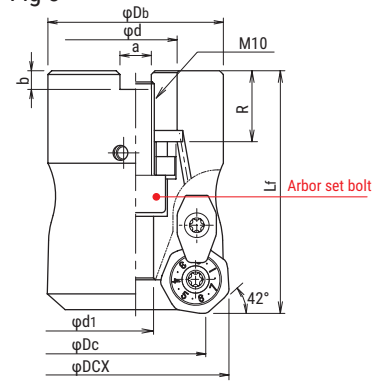

Fig 3



Cat.No.	Stock	No. of inserts	Dimensions (mm)									Arbor set bolt	Parts		Weight (kg)	Inserts	Fig.
			φDc	φDCX	Lf	φDb	φd	φd1	a	b	ℓ		Screw	Wrench			
HEP-3050R-08-22	●	3	36.7	50	65	47	22	9.6	10.4	6.3	19	M10X1.5X25*	DSW-4512H	A-20	0.9	XD**080...	3
HEP-4063R-08-22	●	4	49.5	63	50	60		17				27			20		
HEP-4063R-08-27	●						5	66.6	80	55	76						20
HEP-5080R-08-27	●	6	86.6	100	70	96						32			26		
HEP-6100R-08-32	●						7	111.6	125	70	100						40
HEP-7125R-08-40	●	8	146.6	160	70	100						40			32		
HEP-8160R-08-40	●						9	186.6	200	65	140						140
HEP-9200R-08-60	●	9	186.6	200	65	140						140			25.4		

Screw	Torque(N.m)
DSW-4512H	6

HEPTA MILL **HEP Type**

■ **Insert**

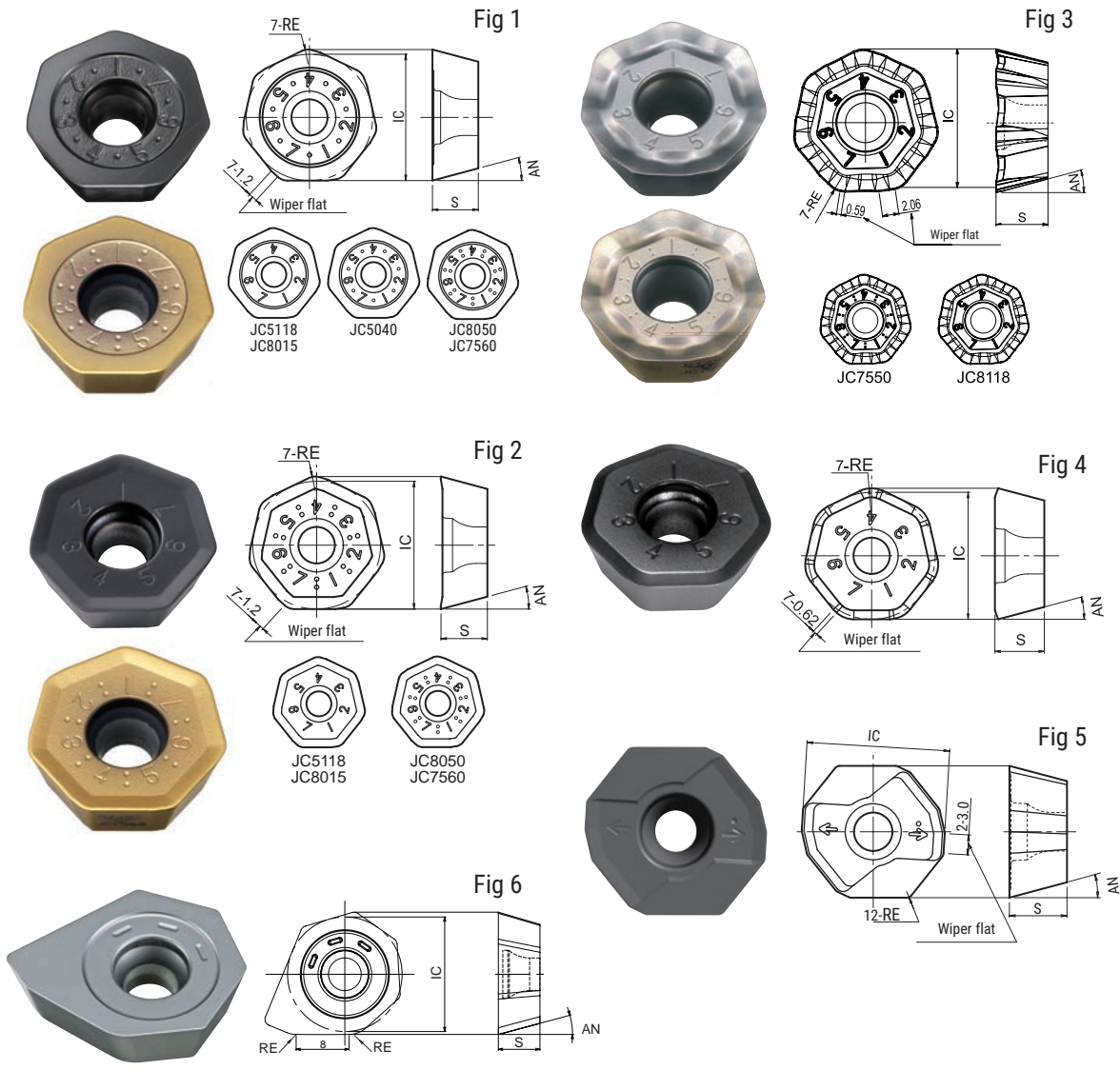

Cat.No.	Tolerance	PVD Coating						Dimensions(mm)				Fig.	
		JC5040	JC7550	JC7560	JC8011	JC8015	JC8050	JC8118	RE	IC	S		AN
XDMW080620ZTR	M	●		●		●	●	●	2	17.5	6.35	15°	1
XDMW080635ZTR-S						●			3.5				4
XDMT080620ZER				●		●	●	●	2				2
XDMT080620ZER-ML		●					●	●		17.341	6.5		3
XDMT080708ZER						○			0.8	18.6	7.5		5
XDHW080610ZER-W		H				●			4	17.5	6.35		6

HEPTA MILL**HEP Type**

■ Recommended cutting conditions

GENERAL CUTTING

Material	Insert	Grade	Tool dia.(mm)									
			50					63				
			3N					4N				
			ℓ (mm)	a_p (mm)	a_e (mm)	n (min ⁻¹)	V_f (mm/min)	ℓ (mm)	a_p (mm)	a_e (mm)	n (min ⁻¹)	V_f (mm/min)
Carbon steel (S50C, S55C) below 250HB	XDMT080620ZER (XDMW080620ZTR) [XDMW080620ZTR]	JC7560 (JC5040) [JC7560]	100	4	~35	900	2,200	100	4	~42	700	2,300
			150	3.5	~35	800	1,700	150	3.5	~42	650	1,800
			200	3	~35	700	1,300	200	3	~42	600	1,500
Tool & die steel (SKD61, SKD11) below 255HB	XDMT080620ZER (XDMW080620ZTR) [XDMW080620ZTR]	JC7560 (JC5040) [JC7560]	100	3	~35	900	1,900	100	3	~42	700	2,000
			150	2.5	~35	800	1,400	150	2.5	~42	650	1,600
			200	2.5	~35	700	1,050	200	2.5	~42	600	1,200
Mold steel (HPM7, PX5, P20) 30-36 HRC	XDMT080620ZER (XDMT080620ZER) [XDMW080620ZTR]	JC8118 (JC7560) [JC5040]	100	3	~35	900	1,900	100	3	~42	700	2,000
			150	2.5	~35	800	1,400	150	2.5	~42	650	1,600
			200	2.5	~35	700	1,050	200	2.5	~42	600	1,200
Mold steel (NAK80, HPM1, P21) 38-43HRC	XDMT080620ZER (XDMT080620ZER) [XDMW080620ZTR]	JC8118 (JC8015) [JC8118]	100	3	~35	650	1,400	100	3	~42	500	1,400
			150	2.5	~35	600	1,100	150	2.5	~42	450	1,100
			200	2.5	~35	500	750	200	2.5	~42	400	700
Hardened die steel (SKD61, DAC, DHA) 42-52HRC	XDMT080620ZER (XDMT080620ZER) [XDMW080620ZTR]	JC8118 (JC8015) [JC8118]	100	2	~25	450	550	100	2	~30	450	700
			150	1.5	~25	400	450	150	1.5	~30	400	600
			200	1.5	~25	350	320	200	1.5	~30	300	350
Grey cast iron (FC250) 160-260HB	XDMW080620ZTR (XDMW080620ZTR) [XDMW080620ZTR-S]	JC8015 (JC8118) [JC8015]	100	5	~35	900	2,700	100	5	~42	700	2,800
			150	4	~35	800	2,400	150	4	~42	600	2,400
			200	3.5	~35	700	1,800	200	3.5	~42	550	2,000
Nodular cast iron (FCD700) 170-300HB	XDMW080620ZTR (XDMW080620ZTR) [XDMW080620ZTR-S]	JC8015 (JC8118) [JC8015]	100	4	~35	750	1,800	100	4	~42	600	2,000
			150	3	~35	680	1,350	150	3	~42	550	1,450
			200	2.5	~35	600	1,000	200	2.5	~42	500	1,150
Austenitic stainless steel (SUS304, 316, 317) 17Cr	XDMT080620ZER (XDMT080620ZER) [XDMT080620ZER-ML]	JC8050 (JC7560) [JC7550]	100	4	~35	800	1,200	100	4	~42	650	1,200
			150	3.5	~35	700	1,000	150	3.5	~42	600	1,000
			200	3	~35	600	700	200	3	~42	500	800
Titanium alloy (Ti-6Al-4V) 35-43HRC	XDMT080620ZER-ML (XDMT080620ZER) [XDMT080620ZER]	JC7550 (JC5040) [JC8118]	100	3	~30	380	250	100	3	~38	300	250
			150	2.5	~30	320	150	150	2.5	~38	250	150
			200	2.5	~30	250	120	200	2.5	~38	200	120
Heat resistant alloy (INCO718) 35-43HRC	XDMT080620ZER-ML (XDMT080620ZER) [XDMT080620ZER]	JC8118 (JC8118) [JC8015]	100	2	~25	200	120	100	2	~30	150	120
			150	1.5	~25	160	80	150	1.5	~30	120	80
			200	1.5	~25	120	60	200	1.5	~30	100	60

Note

1. Please adjust cutting conditions according to machine rigidity or work rigidity.
2. In case of chatter occurring, recommended to reduce a_p or V_f .
3. Use air blow.
4. XDMW080635ZTR-S(JC8015) is recommended to cut cast steel with crusty and nonuniform suarface.

HEPTA MILL**HEP Type**

■ Recommended cutting conditions

GENERAL CUTTING

Material	Insert	Grade	Tool dia.(mm)									
			80					100				
			5N					6N				
			ℓ (mm)	a_p (mm)	a_e (mm)	n (min ⁻¹)	V_f (mm/min)	ℓ (mm)	a_p (mm)	a_e (mm)	n (min ⁻¹)	V_f (mm/min)
Carbon steel (S50C, S55C) below 250HB	XDMT080620ZER (XDMW080620ZTR) [XDMW080620ZTR]	JC7560 (JC5040) [JC7560]	100	4	~55	550	2,200	100	4	~70	450	2,200
			150	4	~55	500	1,800	150	4	~70	400	1,700
			200	3.5	~55	450	1,400	200	3.5	~70	350	1,300
Tool & die steel (SKD61, SKD11) below 255HB	XDMT080620ZER (XDMW080620ZTR) [XDMW080620ZTR]	JC7560 (JC5040) [JC7560]	100	3	~55	550	2,000	100	3	~70	450	1,900
			150	3	~55	500	1,500	150	3	~70	400	1,500
			200	2.5	~55	450	1,100	200	2.5	~70	350	1,100
Mold steel (HPM7, PX5, P20) 30-36 HRC	XDMT080620ZER (XDMT080620ZER) [XDMW080620ZTR]	JC8118 (JC7560) [JC5040]	100	3	~55	550	2,000	100	3	~70	450	1,900
			150	3	~55	500	1,500	150	3	~70	400	1,500
			200	2.5	~55	450	1,100	200	2.5	~70	350	1,100
Mold steel (NAK80, HPM1, P21) 38-43HRC	XDMT080620ZER (XDMT080620ZER) [XDMW080620ZTR]	JC8118 (JC8015) [JC8118]	100	3	~55	400	1,300	100	3	~70	350	1,500
			150	3	~55	350	1,050	150	3	~70	300	1,200
			200	2.5	~55	300	800	200	2.5	~70	250	800
Hardened die steel (SKD61, DAC, DHA) 42-52HRC	XDMT080620ZER (XDMT080620ZER) [XDMW080620ZTR]	JC8118 (JC8015) [JC8118]	100	2	~40	350	700	100	2	~50	250	600
			150	2	~40	300	600	150	2	~50	200	500
			200	1.5	~40	250	400	200	1.5	~50	160	400
Grey cast iron (FC250) 160-260HB	XDMW080620ZTR (XDMW080620ZTR) [XDMW080620ZTR-S]	JC8015 (JC8118) [JC8015]	100	5	~55	550	2,750	100	5	~70	450	2,700
			150	5	~55	500	2,400	150	5	~70	400	2,400
			200	4	~55	450	1,800	200	4	~70	350	2,000
Nodular cast iron (FCD700) 170-300HB	XDMW080620ZTR (XDMW080620ZTR) [XDMW080620ZTR-S]	JC8015 (JC8118) [JC8015]	100	4	~55	450	1,750	100	4	~70	380	1,800
			150	4	~55	400	1,350	150	4	~70	350	1,350
			200	3	~55	380	1,000	200	3	~70	300	1,150
Austenitic stainless steel (SUS304, 316, 317) 17Cr	XDMT080620ZER (XDMT080620ZER) [XDMT080620ZER-ML]	JC8050 (JC7560) [JC7550]	100	4	~55	500	1,200	100	4	~70	400	1,100
			150	4	~55	450	900	150	4	~70	350	1,000
			200	3.5	~55	400	800	200	3.5	~70	300	700
Titanium alloy (Ti-6Al-4V) 35-43HRC	XDMT080620ZER-ML (XDMT080620ZER) [XDMT080620ZER]	JC7550 (JC5040) [JC8118]	100	3	~50	240	240	100	3	~60	200	240
			150	3	~50	200	150	150	3	~60	160	150
			200	2.5	~50	160	120	200	2.5	~60	130	120
Heat resistant alloy (INCO718) 35-43HRC	XDMT080620ZER-ML (XDMT080620ZER) [XDMT080620ZER]	JC8118 (JC8118) [JC8015]	100	2	~40	120	120	100	2	~50	100	120
			150	2	~40	100	75	150	2	~50	80	70
			200	1.5	~40	80	60	200	1.5	~50	70	60

Note

1. Please adjust cutting conditions according to machine rigidity or work rigidity.
2. In case of chatter occurring, recommended to reduce a_p or V_f .
3. Use air blow.
4. XDMW080635ZTR-S(JC8015) is recommended to cut cast steel with crusty and nonuniform suarface.

HEPTA MILL**HEP Type**

■ Recommended cutting conditions

GENERAL CUTTING

Material	Insert	Grade	Tool dia.(mm)									
			125					160				
			7N					8N				
			ℓ (mm)	a_p (mm)	a_e (mm)	n (min ⁻¹)	V_f (mm/min)	ℓ (mm)	a_p (mm)	a_e (mm)	n (min ⁻¹)	V_f (mm/min)
Carbon steel (S50C, S55C) below 250HB	XDMT080620ZER (XDMW080620ZTR) [XDMW080620ZTR]	JC7560 (JC5040) [JC7560]	100	4	~90	350	2,000	100	4	~120	300	1,900
			150	4	~90	320	1,600	150	4	~120	260	1,500
			200	4	~90	300	1,300	200	4	~120	220	1,100
Tool & die steel (SKD61, SKD11) below 255HB	XDMT080620ZER (XDMW080620ZTR) [XDMW080620ZTR]	JC7560 (JC5040) [JC7560]	100	3	~90	350	1,700	100	3	~120	300	1,700
			150	3	~90	320	1,350	150	3	~120	260	1,250
			200	3	~90	300	1,050	200	3	~120	220	900
Mold steel (HPM7, PX5, P20) 30-36 HRC	XDMT080620ZER (XDMT080620ZER) [XDMW080620ZTR]	JC8118 (JC7560) [JC5040]	100	3	~90	350	1,700	100	3	~120	300	1,700
			150	3	~90	320	1,350	150	3	~120	260	1,250
			200	3	~90	300	1,050	200	3	~120	220	900
Mold steel (NAK80, HPM1, P21) 38-43HRC	XDMT080620ZER (XDMT080620ZER) [XDMW080620ZTR]	JC8118 (JC8015) [JC8118]	100	3	~90	300	1,500	100	3	~120	250	1,400
			150	3	~90	250	1,100	150	3	~120	200	1,000
			200	3	~90	200	750	200	3	~120	150	600
Hardened die steel (SKD61, DAC, DHA) 42-52HRC	XDMT080620ZER (XDMT080620ZER) [XDMW080620ZTR]	JC8118 (JC8015) [JC8118]	100	2	~60	200	550	100	2	~80	170	550
			150	2	~60	150	400	150	2	~80	150	500
			200	2	~60	125	260	200	2	~80	120	300
Grey cast iron (FC250) 160-260HB	XDMW080620ZTR (XDMW080620ZTR) [XDMW080620ZTR-S]	JC8015 (JC8118) [JC8015]	100	5	~90	350	2,450	100	5	~120	300	2,250
			150	5	~90	320	2,200	150	5	~120	260	2,100
			200	5	~90	280	1,800	200	5	~120	220	1,700
Nodular cast iron (FCD700) 170-300HB	XDMW080620ZTR (XDMW080620ZTR) [XDMW080620ZTR-S]	JC8015 (JC8118) [JC8015]	100	4	~90	300	1,700	100	4	~120	250	1,500
			150	4	~90	270	1,250	150	4	~120	220	1,200
			200	3	~90	250	1,000	200	4	~120	180	950
Austenitic stainless steel (SUS304, 316, 317) 17Cr	XDMT080620ZER (XDMT080620ZER) [XDMT080620ZER-ML]	JC8050 (JC7560) [JC7550]	100	4	~90	300	1,000	100	4	~120	240	900
			150	4	~90	250	800	150	4	~120	200	750
			200	3	~90	220	650	200	3	~120	180	600
Titanium alloy (Ti-6Al-4V) 35-43HRC	XDMT080620ZER-ML (XDMT080620ZER) [XDMT080620ZER]	JC7550 (JC5040) [JC8118]	100	3	~75	160	220	100	3	~100	120	200
			150	3	~75	130	140	150	3	~100	100	120
			200	3	~75	100	100	200	3	~100	80	100
Heat resistant alloy (INCO718) 35-43HRC	XDMT080620ZER-ML (XDMT080620ZER) [XDMT080620ZER]	JC8118 (JC8118) [JC8015]	100	2	~60	80	120	100	2	~80	60	100
			150	2	~60	65	70	150	2	~80	50	60
			200	2	~60	50	50	200	2	~80	40	50

Note

1. Please adjust cutting conditions according to machine rigidity or work rigidity.
2. In case of chatter occurring, recommended to reduce a_p or V_f .
3. Use air blow.
4. XDMW080635ZTR-S(JC8015) is recommended to cut cast steel with crusty and nonuniform surface.

HEPTA MILL**HEP Type**

■ Recommended cutting conditions

GENERAL CUTTING

Material	Insert	Grade	Tool dia.(mm)									
			200					9N				
			ℓ (mm)	a_p (mm)	a_e (mm)	n (min ⁻¹)	V_f (mm/min)					
Carbon steel (S50C, S55C) below 250HB	XDMT080620ZER (XDMW080620ZTR) [XDMW080620ZTR]	JC7560 (JC5040) [JC7560]	100	4	~150	220	1,600					
			150	4	~150	200	1,300					
			200	4	~150	180	1,000					
Tool & die steel (SKD61, SKD11) below 255HB	XDMT080620ZER (XDMW080620ZTR) [XDMW080620ZTR]	JC7560 (JC5040) [JC7560]	100	3	~150	220	1,400					
			150	3	~150	200	1,100					
			200	3	~150	180	800					
Mold steel (HPM7, PX5, P20) 30-36 HRC	XDMT080620ZER (XDMT080620ZER) [XDMW080620ZTR]	JC8118 (JC7560) [JC5040]	100	3	~150	220	1,400					
			150	3	~150	200	1,100					
			200	3	~150	180	800					
Mold steel (NAK80, HPM1, P21) 38-43HRC	XDMT080620ZER (XDMT080620ZER) [XDMW080620ZTR]	JC8118 (JC8015) [JC8118]	100	3	~150	200	1,100					
			150	3	~150	170	1,000					
			200	3	~150	130	600					
Hardened die steel (SKD61, DAC, DHA) 42-52HRC	XDMT080620ZER (XDMT080620ZER) [XDMW080620ZTR]	JC8118 (JC8015) [JC8118]	100	2	~100	140	500					
			150	2	~100	120	450					
			200	2	~100	100	280					
Grey cast iron (FC250) 160-260HB	XDMW080620ZTR (XDMW080620ZTR) [XDMW080620ZTR-S]	JC8015 (JC8118) [JC8015]	100	5	~150	220	2,000					
			150	5	~150	200	1,800					
			200	5	~150	180	1,400					
Nodular cast iron (FCD700) 170-300HB	XDMW080620ZTR (XDMW080620ZTR) [XDMW080620ZTR-S]	JC8015 (JC8118) [JC8015]	100	4	~150	180	1,350					
			150	4	~150	170	1,000					
			200	3	~150	150	800					
Austenitic stainless steel (SUS304, 316, 317) 17Cr	XDMT080620ZER (XDMT080620ZER) [XDMT080620ZER-ML]	JC8050 (JC7560) [JC7550]	100	4	~150	200	800					
			150	4	~150	160	650					
			200	3	~150	140	550					
Titanium alloy (Ti-6Al-4V) 35-43HRC	XDMT080620ZER-ML (XDMT080620ZER) [XDMT080620ZER]	JC7550 (JC5040) [JC8118]	100	3	~120	100	180					
			150	3	~120	80	110					
			200	3	~120	60	80					
Heat resistant alloy (INCO718) 35-43HRC	XDMT080620ZER-ML (XDMT080620ZER) [XDMT080620ZER]	JC8118 (JC8118) [JC8015]	100	2	~100	50	90					
			150	2	~100	40	60					
			200	2	~100	30	40					

Note

1. Please adjust cutting conditions according to machine rigidity or work rigidity.
2. In case of chatter occurring, recommended to reduce a_p or V_f .
3. Use air blow.
4. XDMW080635ZTR-S(JC8015) is recommended to cut cast steel with crusty and nonuniform surface.

HEPTA MILL**HEP Type**

■ Recommended cutting conditions

UNSTABLE CUTTING

Material	Insert	Grade	Tool dia.(mm)									
			50					63				
			3N					4N				
			ℓ (mm)	a_p (mm)	a_e (mm)	n (min ⁻¹)	V_f (mm/min)	ℓ (mm)	a_p (mm)	a_e (mm)	n (min ⁻¹)	V_f (mm/min)
Carbon steel (S50C, S55C) below 250HB	XDMT080620ZER (XDMW080620ZTR) [XDMW080620ZTR]	JC7560 (JC5040) [JC7560]	100	4	~35	750	1,800	100	4	~42	600	1,950
			150	3.5	~35	680	1,450	150	3.5	~42	550	1,500
			200	3	~35	600	1,100	200	3	~42	500	1,300
Tool & die steel (SKD61, SKD11) below 255HB	XDMT080620ZER (XDMW080620ZTR) [XDMW080620ZTR]	JC7560 (JC5040) [JC7560]	100	3	~35	750	1,600	100	3	~42	600	1,700
			150	2.5	~35	680	1,200	150	2.5	~42	550	1,350
			200	2.5	~35	600	900	200	2.5	~42	500	1,000
Mold steel (HPM7, PX5, P20) 30-36 HRC	XDMT080620ZER (XDMT080620ZER) [XDMW080620ZTR]	JC8118 (JC7560) [JC5040]	100	3	~35	750	1,600	100	3	~42	600	1,700
			150	2.5	~35	680	1,200	150	2.5	~42	550	1,350
			200	2.5	~35	600	900	200	2.5	~42	500	1,000
Mold steel (NAK80, HPM1, P21) 38-43HRC	XDMT080620ZER (XDMT080620ZER) [XDMW080620ZTR]	JC8118 (JC8015) [JC8118]	100	3	~35	550	1,100	100	3	~42	450	1,250
			150	2.5	~35	500	900	150	2.5	~42	400	1,000
			200	2.5	~35	400	600	200	2.5	~42	350	700
Hardened die steel (SKD61, DAC, DHA) 42-52HRC	XDMT080620ZER (XDMT080620ZER) [XDMW080620ZTR]	JC8118 (JC8015) [JC8118]	100	2	~25	450	450	100	2	~30	450	550
			150	1.5	~25	400	350	150	1.5	~30	400	500
			200	1.5	~25	350	250	200	1.5	~30	300	300
Grey cast iron (FC250) 160-260HB	XDMW080620ZTR (XDMW080620ZTR) [XDMW080620ZTR-S]	JC8015 (JC8118) [JC8015]	100	5	~35	750	2,250	100	5	~42	600	2,400
			150	4	~35	680	2,000	150	4	~42	550	2,200
			200	3.5	~35	600	1,500	200	3.5	~42	500	1,700
Nodular cast iron (FCD700) 170-300HB	XDMW080620ZTR (XDMW080620ZTR) [XDMW080620ZTR-S]	JC8015 (JC8118) [JC8015]	100	4	~35	650	1,400	100	4	~42	550	1,500
			150	3	~35	600	1,100	150	3	~42	500	1,200
			200	2.5	~35	500	750	200	2.5	~42	400	800
Austenitic stainless steel (SUS304, 316, 317) 17Cr	XDMT080620ZER (XDMT080620ZER) [XDMT080620ZER-ML]	JC8050 (JC7560) [JC7550]	100	4	~35	650	1,000	100	4	~42	500	1,000
			150	3.5	~35	550	800	150	3.5	~42	450	800
			200	3	~35	500	550	200	3	~42	400	650
Titanium alloy (Ti-6Al-4V) 35-43HRC	XDMT080620ZER-ML (XDMT080620ZER) [XDMT080620ZER]	JC7550 (JC5040) [JC8118]	100	3	~30	300	200	100	3	~38	240	200
			150	2.5	~30	250	120	150	2.5	~38	200	120
			200	2.5	~30	200	100	200	2.5	~38	160	100
Heat resistant alloy (INCO718) 35-43HRC	XDMT080620ZER-ML (XDMT080620ZER) [XDMT080620ZER]	JC8118 (JC8118) [JC8015]	100	2	~25	160	100	100	2	~30	120	100
			150	1.5	~25	130	65	150	1.5	~30	100	65
			200	1.5	~25	100	50	200	1.5	~30	80	50

Note

1. Please adjust cutting conditions according to machine rigidity or work rigidity.
2. In case of chatter occurring, recommended to reduce a_p or V_f .
3. Use air blow.
4. XDMW080635ZTR-S(JC8015) is recommended to cut cast steel with crusty and nonuniform suarface.

HEPTA MILL**HEP Type**

■ Recommended cutting conditions

UNSTABLE CUTTING

Material	Insert	Grade	Tool dia.(mm)									
			80					100				
			5N					6N				
			ℓ (mm)	a_p (mm)	a_e (mm)	n (min ⁻¹)	V_f (mm/min)	ℓ (mm)	a_p (mm)	a_e (mm)	n (min ⁻¹)	V_f (mm/min)
Carbon steel (S50C, S55C) below 250HB	XDMT080620ZER (XDMW080620ZTR) [XDMW080620ZTR]	JC7560 (JC5040) [JC7560]	100	4	~55	450	1,800	100	4	~70	380	1,800
			150	4	~55	400	1,500	150	4	~70	350	1,400
			200	3.5	~55	380	1,200	200	3.5	~70	300	1,100
Tool & die steel (SKD61, SKD11) below 255HB	XDMT080620ZER (XDMW080620ZTR) [XDMW080620ZTR]	JC7560 (JC5040) [JC7560]	100	3	~55	450	1,700	100	3	~70	380	1,600
			150	3	~55	400	1,250	150	3	~70	350	1,250
			200	2.5	~55	380	900	200	2.5	~70	300	900
Mold steel (HPM7, PX5, P20) 30-36 HRC	XDMT080620ZER (XDMT080620ZER) [XDMW080620ZTR]	JC8118 (JC7560) [JC5040]	100	3	~55	450	1,700	100	3	~70	380	1,600
			150	3	~55	400	1,250	150	3	~70	350	1,250
			200	2.5	~55	380	900	200	2.5	~70	300	900
Mold steel (NAK80, HPM1, P21) 38-43HRC	XDMT080620ZER (XDMT080620ZER) [XDMW080620ZTR]	JC8118 (JC8015) [JC8118]	100	3	~55	350	1,150	100	3	~70	300	1,200
			150	3	~55	300	900	150	3	~70	250	900
			200	2.5	~55	250	700	200	2.5	~70	200	550
Hardened die steel (SKD61, DAC, DHA) 42-52HRC	XDMT080620ZER (XDMT080620ZER) [XDMW080620ZTR]	JC8118 (JC8015) [JC8118]	100	2	~40	350	550	100	2	~50	250	500
			150	2	~40	300	500	150	2	~50	200	400
			200	1.5	~40	250	320	200	1.5	~50	160	320
Grey cast iron (FC250) 160-260HB	XDMW080620ZTR (XDMW080620ZTR) [XDMW080620ZTR-S]	JC8015 (JC8118) [JC8015]	100	5	~55	450	2,250	100	5	~70	380	2,250
			150	5	~55	400	1,900	150	5	~70	350	2,000
			200	4	~55	380	1,500	200	4	~70	300	1,700
Nodular cast iron (FCD700) 170-300HB	XDMW080620ZTR (XDMW080620ZTR) [XDMW080620ZTR-S]	JC8015 (JC8118) [JC8015]	100	4	~55	400	1,350	100	4	~70	330	1,200
			150	4	~55	350	1,100	150	4	~70	300	900
			200	3	~55	300	800	200	3	~70	250	750
Austenitic stainless steel (SUS304, 316, 317) 17Cr	XDMT080620ZER (XDMT080620ZER) [XDMT080620ZER-ML]	JC8050 (JC7560) [JC7550]	100	4	~55	400	1,000	100	4	~70	300	900
			150	4	~55	350	700	150	4	~70	300	800
			200	3.5	~55	300	650	200	3.5	~70	250	600
Titanium alloy (Ti-6Al-4V) 35-43HRC	XDMT080620ZER-ML (XDMT080620ZER) [XDMT080620ZER]	JC7550 (JC5040) [JC8118]	100	3	~50	200	200	100	3	~60	160	200
			150	3	~50	160	120	150	3	~60	130	120
			200	2.5	~50	130	100	200	2.5	~60	100	100
Heat resistant alloy (INCO718) 35-43HRC	XDMT080620ZER-ML (XDMT080620ZER) [XDMT080620ZER]	JC8118 (JC8118) [JC8015]	100	2	~40	100	100	100	2	~50	80	100
			150	2	~40	80	60	150	2	~50	65	60
			200	1.5	~40	65	50	200	1.5	~50	60	50

Note

1. Please adjust cutting conditions according to machine rigidity or work rigidity.
2. In case of chatter occurring, recommended to reduce a_p or V_f .
3. Use air blow.
4. XDMW080635ZTR-S(JC8015) is recommended to cut cast steel with crusty and nonuniform surface.

HEPTA MILL**HEP Type**

■ Recommended cutting conditions

UNSTABLE CUTTING

Material	Insert	Grade	Tool dia.(mm)									
			125					160				
			7N					8N				
			ℓ (mm)	a_p (mm)	a_e (mm)	n (min ⁻¹)	V_f (mm/min)	ℓ (mm)	a_p (mm)	a_e (mm)	n (min ⁻¹)	V_f (mm/min)
Carbon steel (S50C, S55C) below 250HB	XDMT080620ZER (XDMW080620ZTR) [XDMW080620ZTR]	JC7560 (JC5040) [JC7560]	100	4	~90	300	1,700	100	4	~120	250	1,600
			150	4	~90	270	1,400	150	4	~120	220	1,200
			200	4	~90	250	1,100	200	4	~120	180	900
Tool & die steel (SKD61, SKD11) below 255HB	XDMT080620ZER (XDMW080620ZTR) [XDMW080620ZTR]	JC7560 (JC5040) [JC7560]	100	3	~90	300	1,400	100	3	~120	250	1,400
			150	3	~90	270	1,100	150	3	~120	220	1,000
			200	3	~90	250	900	200	3	~120	180	750
Mold steel (HPM7, PX5, P20) 30-36 HRC	XDMT080620ZER (XDMT080620ZER) [XDMW080620ZTR]	JC8118 (JC7560) [JC5040]	100	3	~90	300	1,400	100	3	~120	250	1,400
			150	3	~90	270	1,100	150	3	~120	220	1,000
			200	3	~90	250	900	200	3	~120	180	750
Mold steel (NAK80, HPM1, P21) 38-43HRC	XDMT080620ZER (XDMT080620ZER) [XDMW080620ZTR]	JC8118 (JC8015) [JC8118]	100	3	~90	250	1,150	100	3	~120	200	1,100
			150	3	~90	200	800	150	3	~120	150	800
			200	3	~90	150	550	200	3	~120	120	550
Hardened die steel (SKD61, DAC, DHA) 42-52HRC	XDMT080620ZER (XDMT080620ZER) [XDMW080620ZTR]	JC8118 (JC8015) [JC8118]	100	2	~60	200	450	100	2	~80	170	450
			150	2	~60	150	320	150	2	~80	150	400
			200	2	~60	125	200	200	2	~80	120	250
Grey cast iron (FC250) 160-260HB	XDMW080620ZTR (XDMW080620ZTR) [XDMW080620ZTR-S]	JC8015 (JC8118) [JC8015]	100	5	~90	300	2,100	100	5	~120	250	2,000
			150	5	~90	270	1,850	150	5	~120	220	1,750
			200	5	~90	250	1,500	200	5	~120	180	1,450
Nodular cast iron (FCD700) 170-300HB	XDMW080620ZTR (XDMW080620ZTR) [XDMW080620ZTR-S]	JC8015 (JC8118) [JC8015]	100	4	~90	250	1,100	100	4	~120	200	1,000
			150	4	~90	230	850	150	4	~120	170	800
			200	3	~90	200	700	200	4	~120	150	600
Austenitic stainless steel (SUS304, 316, 317) 17Cr	XDMT080620ZER (XDMT080620ZER) [XDMT080620ZER-ML]	JC8050 (JC7560) [JC7550]	100	4	~90	250	800	100	4	~120	200	700
			150	4	~90	200	650	150	4	~120	160	600
			200	3	~90	180	500	200	3	~120	150	500
Titanium alloy (Ti-6Al-4V) 35-43HRC	XDMT080620ZER-ML (XDMT080620ZER) [XDMT080620ZER]	JC7550 (JC5040) [JC8118]	100	3	~75	130	180	100	3	~100	100	160
			150	3	~75	100	110	150	3	~100	80	100
			200	3	~75	80	80	200	3	~100	65	80
Heat resistant alloy (INCO718) 35-43HRC	XDMT080620ZER-ML (XDMT080620ZER) [XDMT080620ZER]	JC8118 (JC8118) [JC8015]	100	2	~60	65	100	100	2	~80	50	80
			150	2	~60	50	60	150	2	~80	40	50
			200	2	~60	40	40	200	2	~80	30	40

Note

1. Please adjust cutting conditions according to machine rigidity or work rigidity.
2. In case of chatter occurring, recommended to reduce a_p or V_f .
3. Use air blow.
4. XDMW080635ZTR-S(JC8015) is recommended to cut cast steel with crusty and nonuniform suarface.

HEPTA MILL**HEP Type**

■ Recommended cutting conditions

UNSTABLE CUTTING

Material	Insert	Grade	Tool dia.(mm)									
			200									
			9N									
ℓ (mm)	a_p (mm)	a_e (mm)	n (min ⁻¹)	V_f (mm/min)								
Carbon steel (S50C, S55C) below 250HB	XDMT080620ZER (XDMW080620ZTR) [XDMW080620ZTR]	JC7560 (JC5040) [JC7560]	100	4	~150	180	1,300					
			150	4	~150	170	1,100					
			200	4	~150	150	850					
Tool & die steel (SKD61, SKD11) below 255HB	XDMT080620ZER (XDMW080620ZTR) [XDMW080620ZTR]	JC7560 (JC5040) [JC7560]	100	3	~150	180	1,200					
			150	3	~150	170	900					
			200	3	~150	150	700					
Mold steel (HPM7, PX5, P20) 30-36 HRC	XDMT080620ZER (XDMT080620ZER) [XDMW080620ZTR]	JC8118 (JC7560) [JC5040]	100	3	~150	180	1,200					
			150	3	~150	170	900					
			200	3	~150	150	700					
Mold steel (NAK80, HPM1, P21) 38-43HRC	XDMT080620ZER (XDMT080620ZER) [XDMW080620ZTR]	JC8118 (JC8015) [JC8118]	100	3	~150	170	1,000					
			150	3	~150	150	800					
			200	3	~150	100	500					
Hardened die steel (SKD61, DAC, DHA) 42-52HRC	XDMT080620ZER (XDMT080620ZER) [XDMW080620ZTR]	JC8118 (JC8015) [JC8118]	100	2	~100	140	400					
			150	2	~100	120	350					
			200	2	~100	100	220					
Grey cast iron (FC250) 160-260HB	XDMW080620ZTR (XDMW080620ZTR) [XDMW080620ZTR-S]	JC8015 (JC8118) [JC8015]	100	5	~150	180	1,600					
			150	5	~150	170	1,500					
			200	5	~150	150	1,200					
Nodular cast iron (FCD700) 170-300HB	XDMW080620ZTR (XDMW080620ZTR) [XDMW080620ZTR-S]	JC8015 (JC8118) [JC8015]	100	4	~150	160	900					
			150	4	~150	140	700					
			200	3	~150	120	500					
Austenitic stainless steel (SUS304, 316, 317) 17Cr	XDMT080620ZER (XDMT080620ZER) [XDMT080620ZER-ML]	JC8050 (JC7560) [JC7550]	100	4	~150	160	650					
			150	4	~150	130	500					
			200	3	~150	110	450					
Titanium alloy (Ti-6Al-4V) 35-43HRC	XDMT080620ZER-ML (XDMT080620ZER) [XDMT080620ZER]	JC7550 (JC5040) [JC8118]	100	3	~120	80	150					
			150	3	~120	65	90					
			200	3	~120	50	65					
Heat resistant alloy (INCO718) 35-43HRC	XDMT080620ZER-ML (XDMT080620ZER) [XDMT080620ZER]	JC8118 (JC8118) [JC8015]	100	2	~100	40	70					
			150	2	~100	30	50					
			200	2	~100	25	30					

Note

1. Please adjust cutting conditions according to machine rigidity or work rigidity.
2. In case of chatter occurring, recommended to reduce a_p or V_f .
3. Use air blow.
4. XDMW080635ZTR-S(JC8015) is recommended to cut cast steel with crusty and nonuniform surface.

AERO CHIPPER

ALX/MAL Type

High Precision & High Efficient Machining on Aerospace tooling

G-Body

Aerospace Tooling

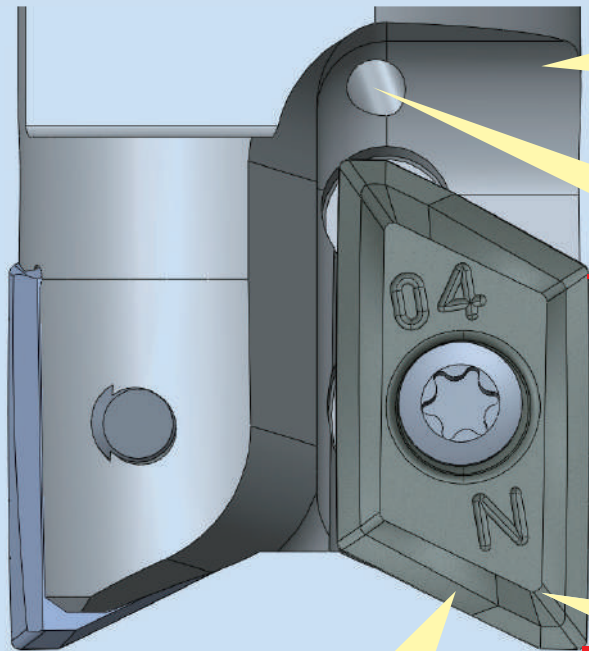

G-Body

Through coolant hole

High Precision

Combination of high accuracy body and ground insert gives excellent side wall finish.

High Efficiency

Sharp & Unique 3D geometry insert enables high efficiency and low cutting resistance machining. Key in insert gives added security allowing high speed spindle machining.

Multi Function

Capable of ramping & helical interpolation

G-Body

G-Body is a GN surface- hardening treatment on thermal resistant high strength steel giving a hardness over 65HRC and secures insert pocket and holder against thermal deformation improving body durability.

AERO CHIPPER **ALX/MAL Type**

■ **Facemill Type**

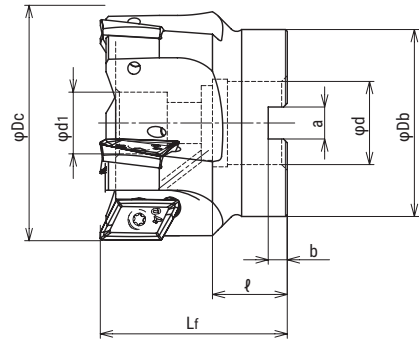
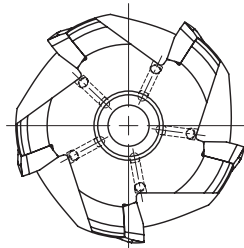
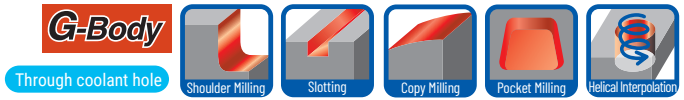

Cat.No.	Stock	No. of inserts	Dimensions(mm)								Max. spindle speed	Weight (kg)	Inserts
			φDc	Lf	φDb	φd	φd1	a	b	ℓ			
ALX4050R-22	●	4	50	50	45	22	16.5	10.4	6.3	20	24,000	0.4	XOGT1605**PD*R
ALX5063R-22	●	5	63		50						21,000	0.6	

Screw	Torque(N.m)	Wrench
DSW-4085	3.6	A-15T

■ **Note: Use of XOGT160540PDFR insert**

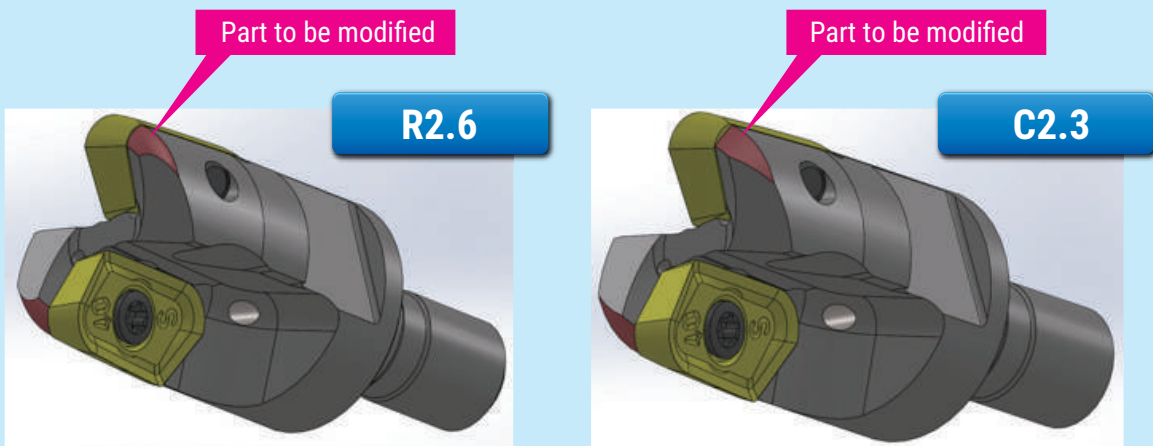

When using inserts with corner radius RE 4 (XOGT160540PDFR), Standard cutter body has to be modified with R2.6 or C2.3

AERO CHIPPER

ALX/MAL Type

■ Endmill Shank Type

G-Body

Through coolant hole

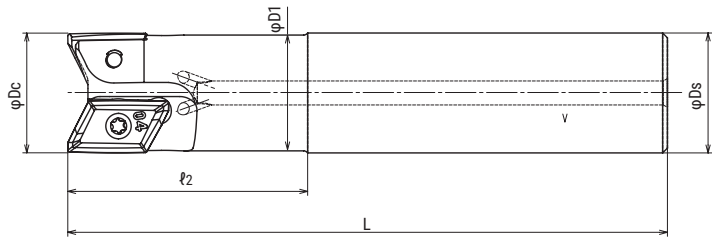

Cat.No.	Stock	No. of inserts	Dimensions(mm)						Max. spindle speed	Parts		Inserts
			φD_c	ℓ	ℓ_2	L	φD_1	φD_s		Screw	Wrench	
ALXM1020S20	●	1	20	75	35	110	19.18	20	15,000	DSW-4075H	A-15	XOGT1605**PD*R
ALXM2025S25	●	2	25		50	125	24	25	40,000	DSW-4085		
ALXM2028S25	●		28	100								
ALXM2032S32	●		32		30.5	33.32	31,000					
ALXM2035S32	●		35	32				28,000				
ALXM3040S32	●	3	40		90	80	170		37.96			

Screw	Torque(N.m)
DSW-4075H	3.6
DSW-4085	3.6

AERO CHIPPER **ALX/MAL Type**

■ **Modular Head Type**

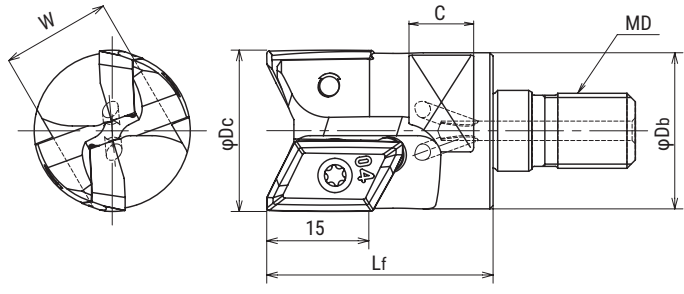

Cat.No.	Stock	No. of inserts	Dimensions(mm)						Max. spindle speed	Inserts
			φDc	Lf	φDb	MD	C	W		
MAL-1020-M10	●	1	20	35	19.5	M10	9	14	15,000	XOGT1605**PD*R
MAL-2025-M12	●	2	25		24	M12	10	19	40,000	
MAL-2028-M12	●		28						36,000	
MAL-2030-M16	●	2	30	43	28	M16	12	22	34,000	
MAL-2032-M16	●		32		33,000					
MAL-2035-M16	●		35		29				M16	
MAL-3040-M16	●	3	40		32	M16	14	26	28,000	

Screw	Torque(N.m)	Wrench
DSW-4085	3.6	A-15

AERO CHIPPER

ALX/MAL Type

■ **Insert**



Cat.No.	Tolerance	PVD Coating	Uncoated	Dimensions (mm)						
		JC5118	FZ05	RE	L	W1	S	C		
XOGT160502PDFR	G		●	0.2	20.8	16.35	5	2.5		
XOGT160504PDFR			●	0.4	21			2.4		
XOGT160508PDFR			●	0.8				2.5		
XOGT160512PDFR			●	1.2	20.9			2.6		
XOGT160516PDFR			●	1.6	20.7			2.8		
XOGT160520PDFR			●	2	20.6			3		
XOGT160525PDFR			●	2.5	20.3			3.3		
XOGT160530PDFR			●	3	20.1			3.5		
XOGT160532PDFR			●	3.2	19.9			4.3		
XOGT160540PDFR			●	4	19.2			2.5		
XOGT160502PDER			●		0.2			20.8	21	2.4
XOGT160504PDER			●		0.4			20.9		2.5
XOGT160508PDER			●		0.8				20.7	2.6
XOGT160512PDER			●		1.2			20.6	2.8	
XOGT160516PDER			●		1.6			20.1	3.3	
XOGT160520PDER			●		2			19.9	3.5	
XOGT160530PDER			●		3					
XOGT160532PDER			●		3.2					

AERO CHIPPER

ALX/MAL Type

Recommended Data for Profile Milling

Ramping

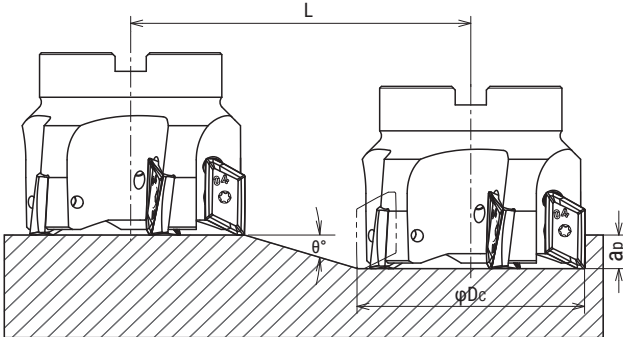

Tool dia. (mm)	Aluminium		Stainless steel		Titanium alloy		Max. Depth of cut (mm)
	Max. ramping angle (°)	Cutting length (mm)	Max. ramping angle (°)	Cutting length (mm)	Max. ramping angle (°)	Cutting length (mm)	
φDc	θ°	L	θ°	L	θ°	L	ap
20	16	28	10	45	10	45	8
25	11	41	9	51	9	51	8
28	9	51	7	65	7	65	8
30	8	57	6	76	6	76	8
32	7	65	6	76	6	76	8
35	6	76	6	76	6	76	8
40	5	91	5	91	5	91	8
50	4	114	4	114	4	114	8
63	3	153	3	153	3	153	8

Note

1. In case of ramping, apply 70% or less feed (Vf) from standard cutting condition table.
2. When cutting Titanium/Stainless steel, apply 0.005mm or less (fz) from standard cutting condition table.
3. Wet cutting is recommended.

Helical interpolation

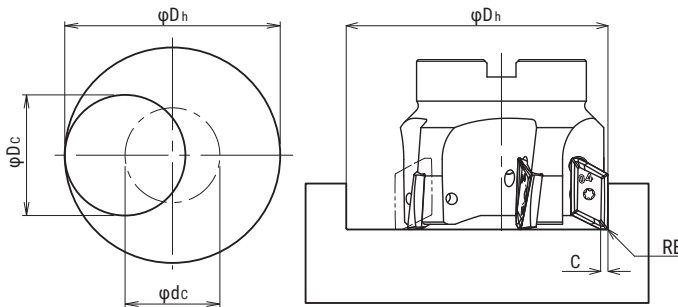

- Calculation of tool pass dia.

$$\phi_{dc} = \phi_{Dh} - \phi_{Dc}$$

Tool pass dia. Bore dia. Tool dia.

- Depth of cut per one circuit should not exceed max. depth of cut Ap
- Down cutting is recommended, tool pass rotation should be counterclockwise

Tool dia. (mm)	Min.bore dia. (mm)	Max. Bore dia. (mm)	Max.Depth of cut (mm)		
			Aluminium	Stainless steel	Titanium alloy
φDc	φDh min.	φDh max.			
20	35.8	38.6	15	9	9
25	45.8	48.6	13	11	11
28	51.8	54.6	12	10	10
30	55.8	58.6	11	10	10
32	59.8	62.6	11	10	10
35	65.8	68.6	11	11	11
40	75.8	78.6	10	10	10
50	96.8	98.6	10	10	10
63	122.8	124.6	10	10	10

Note

1. In case of helical interpolation, apply 70% or less feed (Vf) from standard cutting condition table.
2. When cutting Titanium/Stainless steel, apply 0.005mm or less (fz) from standard cutting condition table.
3. Wet cutting is recommended.

Drilling

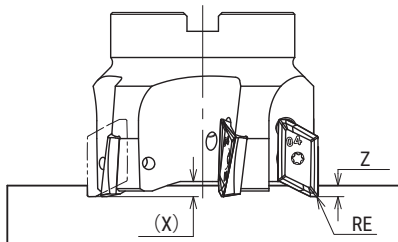

Coner radius R (mm)	Max. depth of cut: Z (mm)
RE	Z
R2.5 or below	3
R3 / R3.2	2
R4	1.5

Note

1. Do not combine drilling and ramping together.
2. In case of drilling, apply 50% or less feed (Vf) from standard cutting condition table.
3. Long chips may come out in case of drilling, confirm safe operating conditions.

AERO CHIPPER

ALX/MAL Type

■ Recommended cutting conditions

● Facemill types

Material	Grade	Tool dia.(mm)									
		50					63				
		ℓ (mm)	ap (mm)	ae (mm)	n (min ⁻¹)	Vf (mm/min)	ℓ (mm)	ap (mm)	ae (mm)	n (min ⁻¹)	Vf (mm/min)
Aluminium alloy below 50-110HB	FZ05	100	8	35	6,300	5,040	100	8	45	5,000	5,000
		150	4	35	6,300	3,020	150	4	45	5,000	3,000
		200	3	35	6,300	1,760	200	3	45	5,000	1,750
Stainless steel below 250HB	JC5118	100	3	35	950	380	100	2	45	760	380
		150	2	35	950	190	150	2	45	760	190
Titanium alloy 35-43HRC	JC5118	100	8	35	380	122	100	8	45	300	120
		150	4	35	380	106	150	4	45	300	105
		200	2	35	380	91	200	2	45	300	90

Note

1. Please adjust cutting conditions according to machine rigidity or work rigidity.
2. In case of chatter occurring, recommended to reduce ap or Vf.
3. In case of slot milling, apply 70% or less feed (Vf) and (n) from standard cutting condition table and apply ap=8mm or below.

● Endmill type

Material	Grade	Application	Tool dia.(mm)											
			20				25				28			
			ap (mm)	ae (mm)	n (min ⁻¹)	Vf (mm/min)	ap (mm)	ae (mm)	n (min ⁻¹)	Vf (mm/min)	ap (mm)	ae (mm)	n (min ⁻¹)	Vf (mm/min)
Aluminium alloy below 50-110HB	FZ05	Shoulder milling	12	4	14,000	2,800	12	5	12,000	4,800	12	5.6	11,000	4,400
		Slot milling	8	14	14,000	2,520	8	18	12,000	4,320	8	20	11,000	3,960
		Slot milling	6	20	12,000	2,400	6	25	10,000	4,000	8	28	9,200	3,680
Stainless steel below 250HB	JC5118	Shoulder milling	5	4	2,400	240	5	5	1,900	380	5	6	1,700	340
		Slot milling	2	14	2,400	240	2	8	1,900	380	2	20	1,700	340
		Slot milling	2	20	2,000	100	2	25	1,600	160	2	28	1,400	140
Titanium alloy 35-43HRC	JC5118	Shoulder milling	12	4	950	95	12	5	764	153	12	5.6	685	137
		Slot milling	8	14	950	76	8	18	764	122	8	20	685	110
		Slot milling	6	20	800	64	6	25	640	102	8	28	570	91

Material	Grade	Application	Tool dia.(mm)											
			32				35				40			
			ap (mm)	ae (mm)	n (min ⁻¹)	Vf (mm/min)	ap (mm)	ae (mm)	n (min ⁻¹)	Vf (mm/min)	ap (mm)	ae (mm)	n (min ⁻¹)	Vf (mm/min)
Aluminium alloy below 50-110HB	FZ05	Shoulder milling	12	6.4	9,500	3,800	12	7	9,000	3,600	12	8	7,800	4,680
		Slot milling	8	22	9,500	3,420	8	25	9,000	3,240	8	28	7,800	4,210
		Slot milling	8	32	8,000	3,200	8	35	7,200	2,880	8	40	6,400	3,840
Stainless steel below 250HB	JC5118	Shoulder milling	8	6	1,500	300	8	7	1,355	271	3	8	1,200	360
		Slot milling	3	22	1,500	300	3	25	1,355	271	2	28	1,200	360
		Slot milling	2	32	1,200	120	2	35	1,100	110	1	40	1,000	150
Titanium alloy 35-43HRC	JC5118	Shoulder milling	12	6.4	600	120	12	7	545	109	12	8	480	144
		Slot milling	8	22	600	96	8	25	545	87	8	28	480	115
		Slot milling	8	32	500	80	8	35	450	72	8	40	400	96

Note

1. Please adjust cutting conditions according to machine rigidity or work rigidity.
2. In case of chatter occurring, recommended to reduce ap or Vf.

AERO CHIPPER**ALX/MAL Type**

■ Recommended cutting conditions

Modular head MAL type + MSN shank**SHOULDER MILLING**

Material	Grade	Tool dia.(mm)														
		20					25					28				
		ℓ (mm)	ap (mm)	ae (mm)	n (min ⁻¹)	Vf (mm/min)	ℓ (mm)	ap (mm)	ae (mm)	n (min ⁻¹)	Vf (mm/min)	ℓ (mm)	ap (mm)	ae (mm)	n (min ⁻¹)	Vf (mm/min)
Aluminium alloy below 50-110HB	FZ05	75	10	4	14,000	840	90	15	5	12,000	4,800	90	12	5.6	11,000	2,640
		125	3	4	14,000	700	140	8	5	12,000	2,400	140	6	5.6	11,000	1,320
		175	1	4	10,000	500	190	3	5	9,000	1,200	190	3	5.6	9,000	900
Stainless steel below 250HB	JC5118	60	4	4	2,400	240	60	7	5	1,900	380	90	4	5.6	1,700	340
		90	2	4	1,900	95	90	4	5	1,540	154	110	3	5.6	1,350	135
Titanium alloy 35-43HRC	JC5118	60	10	4	950	57	60	15	5	764	153	90	10	5.6	685	110
		90	5	4	950	38	90	8	5	764	92	110	6	5.6	685	69

Material	Grade	Tool dia.(mm)														
		30					32					35				
		ℓ (mm)	ap (mm)	ae (mm)	n (min ⁻¹)	Vf (mm/min)	ℓ (mm)	ap (mm)	ae (mm)	n (min ⁻¹)	Vf (mm/min)	ℓ (mm)	ap (mm)	ae (mm)	n (min ⁻¹)	Vf (mm/min)
Aluminium alloy below 50-110HB	FZ05	100	10	6	10,100	3,030	100	10	6.4	9,500	2,850	100	10	7	9,000	4,500
		150	6	6	10,100	1,620	150	6	6.4	9,500	1,520	150	5	7	9,000	2,700
		200	4	6	8,500	850	200	4	6.4	8,000	800	200	4	7	7,200	1,152
Stainless steel below 250HB	JC5118	90	5	6	1,600	320	90	5	6.4	1,500	300	100	4	7	1,355	270
		120	3	6	1,300	130	120	3	6.4	1,200	120	150	3	7	1,100	110
Titanium alloy 35-43HRC	JC5118	90	10	6	640	130	90	10	6.4	600	120	100	10	7	545	109
		120	6	6	640	100	120	6	6.4	600	96	150	6	7	545	76

Material	Grade	Tool dia.(mm)														
		40														
		ℓ (mm)	ap (mm)	ae (mm)	n (min ⁻¹)	Vf (mm/min)										
Aluminium alloy below 50-110HB	FZ05	100	12	8	7,800	5,850										
		150	8	8	7,800	3,510										
		200	5	8	6,400	1,920										
Stainless steel below 250HB	JC5118	100	4	8	1,200	360										
		150	2	8	950	143										
Titanium alloy 35-43HRC	JC5118	100	12	8	480	144										
		150	6	8	480	101										

Note

1. Please adjust cutting conditions according to machine rigidity or work rigidity.
2. In case of chatter occurring, recommended to reduce ap or Vf.

AERO CHIPPER

ALX/MAL Type

■ Recommended cutting conditions
Modular head MAL type + MSN shank

SHOULDER MILLING

Material	Grade	Tool dia.(mm)														
		20					25					28				
		ℓ (mm)	ap (mm)	ae (mm)	n (min ⁻¹)	Vf (mm/min)	ℓ (mm)	ap (mm)	ae (mm)	n (min ⁻¹)	Vf (mm/min)	ℓ (mm)	ap (mm)	ae (mm)	n (min ⁻¹)	Vf (mm/min)
Aluminium alloy below 50-110HB	FZ05	75	4	14	14,000	1,120	90	8	18	12,000	4,800	90	7	20	11,000	2,640
		125	2	14	14,000	700	140	5	18	12,000	2,400	140	4	20	11,000	1,540
		175	0.5	14	10,000	500	190	2	18	9,000	1,200	190	2	20	9,000	900
Stainless steel below 250HB	JC5118	60	2	14	2,400	240	60	3	18	1,900	380	90	2	20	1,700	272
		90	1	14	1,900	95	90	2	18	1,540	154	110	1	20	1,350	108
Titanium alloy 35-43HRC	JC5118	60	6	14	950	76	60	10	18	764	122	90	7	20	685	110
		90	3	14	950	48	90	6	18	764	76	110	3	20	685	69

Material	Grade	Tool dia.(mm)														
		30					32					35				
		ℓ (mm)	ap (mm)	ae (mm)	n (min ⁻¹)	Vf (mm/min)	ℓ (mm)	ap (mm)	ae (mm)	n (min ⁻¹)	Vf (mm/min)	ℓ (mm)	ap (mm)	ae (mm)	n (min ⁻¹)	Vf (mm/min)
Aluminium alloy below 50-110HB	FZ05	100	7	21	10,100	3,030	100	7	22	9,500	2,850	100	8	25	9,000	3,600
		150	4	21	10,100	1,620	150	4	22	9,500	1,520	150	5	25	9,000	1,800
		200	2	21	8,530	850	200	2	22	8,000	800	200	3	25	7,200	1,000
Stainless steel below 250HB	JC5118	90	3	21	1,600	260	90	3	22	1,500	240	100	2	25	1,355	217
		120	1	21	1,280	130	120	1	22	1,200	120	150	1	25	1,100	110
Titanium alloy 35-43HRC	JC5118	90	7	21	640	100	90	7	22	600	96	100	8	25	545	87
		120	3	21	640	64	120	3	22	600	60	150	4	25	545	55

Material	Grade	Tool dia.(mm)														
		40														
		ℓ (mm)	ap (mm)	ae (mm)	n (min ⁻¹)	Vf (mm/min)										
Aluminium alloy below 50-110HB	FZ05	100	8	28	7,800	5,850										
		150	6	28	7,800	2,800										
		200	4	28	6,400	1,500										
Stainless steel below 250HB	JC5118	100	2	28	1,200	288										
		150	1	28	950	114										
Titanium alloy 35-43HRC	JC5118	100	8	28	480	115										
		150	3	28	480	72										

Note

1. Please adjust cutting conditions according to machine rigidity or work rigidity.
2. In case of chatter occurring, recommended to reduce ap or Vf.

AERO CHIPPER**ALX/MAL Type**

■ Recommended cutting conditions

Modular head MAL type + MSN shank**SLOT MILLING**

Material	Grade	Tool dia.(mm)											
		20				25				28			
		ℓ (mm)	a _p (mm)	n (min ⁻¹)	V _f (mm/min)	ℓ (mm)	a _p (mm)	n (min ⁻¹)	V _f (mm/min)	ℓ (mm)	a _p (mm)	n (min ⁻¹)	V _f (mm/min)
Aluminium alloy below 50-110HB	FZ05	75	2.5	14,000	2,100	90	8	12,000	4,800	90	6	11,000	4,400
		125	1	14,000	980	140	6	12,000	2,400	140	3	11,000	2,200
		175	0.5	10,000	500	190	2	9,000	1,200	190	2	9,000	900
Stainless steel below 250HB	JC5118	60	2	2,400	240	60	2	1,900	380	90	2	1,700	272
		90	1	1,900	95	90	1	1,540	154	110	1	1,350	108
Titanium alloy 35-43HRC	JC5118	60	6	800	64	60	8	640	102	90	6	570	91
		90	3	800	40	90	4	640	77	120	3	570	68

Material	Grade	Tool dia.(mm)											
		30				32				35			
		ℓ (mm)	a _p (mm)	n (min ⁻¹)	V _f (mm/min)	ℓ (mm)	a _p (mm)	n (min ⁻¹)	V _f (mm/min)	ℓ (mm)	a _p (mm)	n (min ⁻¹)	V _f (mm/min)
Aluminium alloy below 50-110HB	FZ05	100	6	10,100	4,040	100	6	9,500	3,800	100	6	9,000	3,600
		150	3	10,100	2,020	150	3	9,500	1,900	150	4	9,000	1,800
		200	2	8,500	1,360	200	2	8,000	1,280	200	2	7,200	1,150
Stainless steel below 250HB	JC5118	90	2	1,600	260	90	2	1,500	240	100	2	1,355	217
		120	1	1,280	130	120	1	1,200	120	120	1	1,100	110
Titanium alloy 35-43HRC	JC5118	90	8	530	85	90	8	500	80	100	8	450	72
		120	4	530	64	120	4	500	60	120	4	450	54

Material	Grade	Tool dia.(mm)											
		40											
		ℓ (mm)	a _p (mm)	n (min ⁻¹)	V _f (mm/min)								
Aluminium alloy below 50-110HB	FZ05	100	8	7,800	4,680								
		150	5	7,800	3,510								
		200	3	6,400	1,920								
Stainless steel below 250HB	JC5118	100	2	1,200	288								
		150	1	950	114								
Titanium alloy 35-43HRC	JC5118	100	8	400	96								
		150	4	400	72								

Note

1. Please adjust cutting conditions according to machine rigidity or work rigidity.
2. In case of chatter occurring, recommended to reduce a_p or V_f.

S-HEAD **SMSA Type**

■ **SMSA Type**

Through coolant hole



Solid Carbide Modular Head with highly repetitive ground screw

- Applicable for General steel, Stainless steel, Heat resistant alloys and Titanium alloys.
- High accuracy for finishing both side walls and bottom surfaces.
- Coolant through the center of head.
- Available in 6 or 8 flutes.

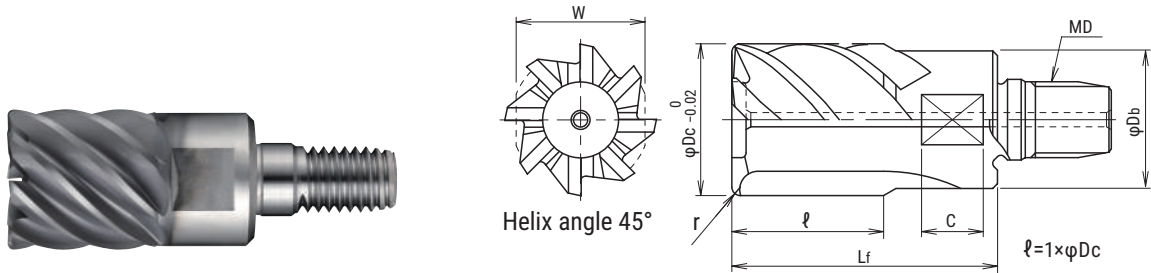

Cat.No.	Stock	No. of inserts	Dimensions (mm)							
			φDc	r	ℓ	Lf	φDb	MD	C	W
SMSA-8160R05-M8	●	8	16	0.5	16	30	15	M8	5.5	14
SMSA-8160R10-M8	●			1						
SMSA-6160R20-M8	●			2						
SMSA-6160R30-M8	●			3						
SMSA-8200R05-M10	●	8	20	0.5	20	35	19	M10		
SMSA-8200R10-M10	●			1						
SMSA-8200R20-M10	●			2						
SMSA-6200R30-M10	●	6	25	25	43	24	M12			
SMSA-8250R10-M12	●	8						1		
SMSA-8250R20-M12	●	2								
SMSA-6250R30-M12	●	6	30	30	56	29	M16			
SMSA-8300R10-M16	●	8						1		
SMSA-8300R20-M16	●	2								
SMSA-6300R30-M16	●	6	32	32	56	30	M16			
SMSA-8320R10-M16	●	8						1		
SMSA-8320R20-M16	●	2								
SMSA-6320R30-M16	●	6		3					27	

PROPER MOUNTING OF S-HEAD

Use DIJET DS type spanner wrench to prevent over-tightening

Tightening torque



Tool dia. φDc (mm)	Width Across Flat W (mm)	Cat.No.	Tightening torque
φ16	14	DS-14	10~11N·m
φ20	17	DS-17	10~16N·m
φ25	22	DS-22	15~20N·m
φ30	27	DS-27	20~25N·m
φ32	27	DS-27	20~25N·m

S-HEAD **SMSA Type**

■ Recommended cutting conditions

● Side cutting

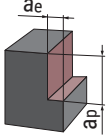
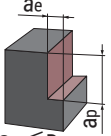
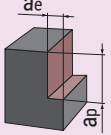
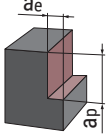
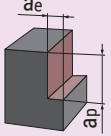
Material	Depth of cut 	Tool dia. (mm)					
		16			20		
		ℓ (mm)	n (min ⁻¹)	Vf (mm/min)	ℓ (mm)	n (min ⁻¹)	Vf (mm/min)
Carbon steel (S50C, S55C) below 250HB	 $a_p \leq D_c$ $a_e \leq 0.03D_c$	70	2,000	500	75	1,600	400
		110	1,800	400	125	1,400	300
		150	1,600	300	175	1,200	250
Mold steel (NAK80, HPM1, P21) 38-43HRC	 $a_p \leq D_c$ $a_e \leq 0.03D_c$	70	1,400	300	75	1,100	280
		110	1,200	240	125	950	200
		150	1,000	180	175	800	150
Austenitic stainless steel (SUS304, 316, 317)	 $a_p \leq D_c$ $a_e \leq 0.03D_c$	70	2,000	500	75	1,600	400
		110	1,800	400	125	1,400	300
		150	1,600	300	175	1,200	250
Aluminium alloy (A5052)	 $a_p \leq D_c$ $a_e \leq 0.03D_c$	70	4,000	900	75	3,200	800
		110	3,600	800	125	2,800	600
		150	3,200	700	175	2,500	500
Titanium alloy (Ti-6Al-4V) 35-43HRC	 $a_p \leq D_c$ $a_e \leq 0.03D_c$	70	1,400	300	75	1,100	280
		110	1,200	240	125	950	200
		150	1,000	180	175	800	150
Heat resistant alloy (INCO718) 35-43HRC	 $a_p \leq D_c$ $a_e \leq 0.03D_c$	70	800	200	75	600	150
		110	700	150	125	550	120
		150	600	120	175	500	100

Note

1. When finishing side wall, reduce a_e and increase a_p for higher efficiency and for preventing more heat generation.
2. When finishing bottom face, reduce a_p and increase V_f to optimize use of corner radius geometry for high feed machining.
3. Use appropriate coolant.

S-HEAD
SMSA Type
■ Recommended cutting conditions
● Side cutting

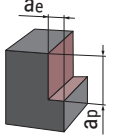
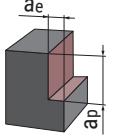
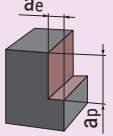
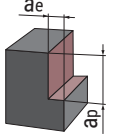
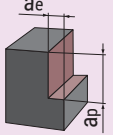
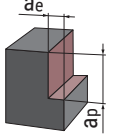
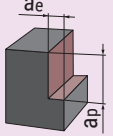
Material	Depth of cut 	Tool dia. (mm)					
		25			30/32		
		φ (mm)	n (min ⁻¹)	V_f (mm/min)	φ (mm)	n (min ⁻¹)	V_f (mm/min)
Carbon steel (S50C, S55C) below 250HB $a_p \leq D_c$ $a_e \leq 0.03D_c$		100	1,300	300	110	1,000	240
		150	1,150	250	160	900	200
		200	1,000	200	210	800	160
Mold steel (NAK80, HPM1, P21) 38-43HRC $a_p \leq D_c$ $a_e \leq 0.03D_c$		100	900	240	110	700	180
		150	800	180	160	600	130
		200	600	120	210	500	100
Austenitic stainless steel (SUS304, 316, 317) $a_p \leq D_c$ $a_e \leq 0.03D_c$		100	1,300	300	110	1,000	240
		150	1,150	250	160	900	200
		200	1,000	200	210	800	160
Aluminium alloy (A5052) $a_p \leq D_c$ $a_e \leq 0.03D_c$		100	2,600	650	110	2,000	500
		150	2,300	500	160	1,800	400
		200	2,000	400	210	1,600	300
Titanium alloy (Ti-6Al-4V) 35-43HRC $a_p \leq D_c$ $a_e \leq 0.03D_c$		100	900	240	110	700	180
		150	800	180	160	600	130
		200	600	120	210	500	100
Heat resistant alloy (INCO718) 35-43HRC $a_p \leq D_c$ $a_e \leq 0.03D_c$		100	500	120	110	400	100
		150	450	100	160	380	90
		200	400	80	210	350	80

Note

1. When finishing side wall, reduce a_e and increase a_p for higher efficiency and for preventing more heat generation.
2. When finishing bottom face, reduce a_p and increase V_f to optimize use of corner radius geometry for high feed machining.
3. Use appropriate coolant.

S-HEAD **SMSA Type**

■ Recommended cutting conditions

● Bottom cutting

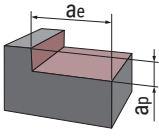
Material	Depth of cut 	Tool dia. (mm)					
		16			20		
		ℓ (mm)	n (min ⁻¹)	V_f (mm/min)	ℓ (mm)	n (min ⁻¹)	V_f (mm/min)
Carbon steel (S50C, S55C) below 250HB	$a_e \leq D_c$ $a_p \leq 0.03D_c$	70	2,000	1,600	75	1,600	1,300
		110	1,800	1,400	125	1,400	1,100
		150	1,600	1,200	175	1,200	950
Mold steel (NAK80, HPM1, P21) 38-43HRC	$a_e \leq D_c$ $a_p \leq 0.03D_c$	70	1,400	1,100	75	1,100	900
		110	1,200	950	125	950	800
		150	1,000	800	175	800	600
Austenitic stainless steel (SUS304, 316, 317)	$a_e \leq D_c$ $a_p \leq 0.03D_c$	70	2,000	1,600	75	1,600	1,300
		110	1,800	1,400	125	1,400	1,100
		150	1,600	1,200	175	1,200	950
Aluminium alloy (A5052)	$a_e \leq D_c$ $a_p \leq 0.03D_c$	70	4,000	3,200	75	3,200	2,500
		110	3,600	2,800	125	2,800	2,200
		150	3,200	2,500	175	2,500	2,000
Titanium alloy (Ti-6Al-4V) 35-43HRC	$a_e \leq D_c$ $a_p \leq 0.03D_c$	70	1,400	1,100	75	1,100	900
		110	1,200	950	125	950	800
		150	1,000	800	175	800	600
Heat resistant alloy (INCO718) 35-43HRC	$a_e \leq D_c$ $a_p \leq 0.03D_c$	70	800	650	75	600	500
		110	700	550	125	550	450
		150	600	500	175	500	400

Note

1. When finishing side wall, reduce a_e and increase a_p for higher efficiency and for preventing more heat generation.
2. When finishing bottom face, reduce a_p and increase V_f to optimize use of corner radius geometry for high feed machining.
3. Use appropriate coolant.

S-HEAD
SMSA Type
Recommended cutting conditions
Bottom cutting

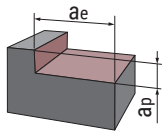
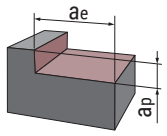
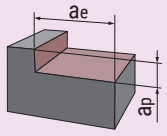
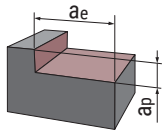
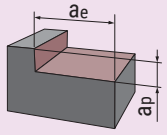
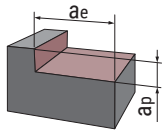
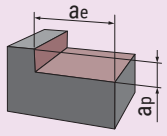
Material	Depth of cut 	Tool dia. (mm)					
		25			30/32		
		ℓ (mm)	n (min ⁻¹)	V_f (mm/min)	ℓ (mm)	n (min ⁻¹)	V_f (mm/min)
Carbon steel (S50C, S55C) below 250HB $a_e \leq D_c$ $a_p \leq 0.03D_c$		100	1,300	1,000	110	1,000	800
		150	1,150	900	160	900	700
		200	1,000	800	210	800	600
Mold steel (NAK80, HPM1, P21) 38-43HRC $a_e \leq D_c$ $a_p \leq 0.03D_c$		100	900	700	110	700	550
		150	800	600	160	600	500
		200	600	500	210	500	400
Austenitic stainless steel (SUS304, 316, 317) $a_e \leq D_c$ $a_p \leq 0.03D_c$		100	1,300	1,000	110	1,000	800
		150	1,150	900	160	900	700
		200	1,000	800	210	800	600
Aluminium alloy (A5052) $a_e \leq D_c$ $a_p \leq 0.03D_c$		100	2,600	2,000	110	2,000	1,600
		150	2,300	1,800	160	1,800	1,400
		200	2,000	1,600	210	1,600	1,200
Titanium alloy (Ti-6Al-4V) 35-43HRC $a_e \leq D_c$ $a_p \leq 0.03D_c$		100	900	700	110	700	550
		150	800	600	160	600	500
		200	600	500	210	500	400
Heat resistant alloy (INCO718) 35-43HRC $a_e \leq D_c$ $a_p \leq 0.03D_c$		100	500	400	110	400	320
		150	450	360	160	380	300
		200	400	320	210	360	280

Note

1. When finishing side wall, reduce a_e and increase a_p for higher efficiency and for preventing more heat generation.
2. When finishing bottom face, reduce a_p and increase V_f to optimize use of corner radius geometry for high feed machining.
3. Use appropriate coolant.

S-HEAD **SMAL Type**

■ **SMAL Type**

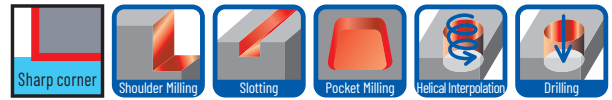

S-HEAD for Aluminium

- Solid carbide modular head with multi-edges for aluminum.
- Positive geometry with 45 degree helix angle & 20 degree rake angle.
- 3 flutes allow excellent chip ejection.
- Through coolant holes prevent material welding.

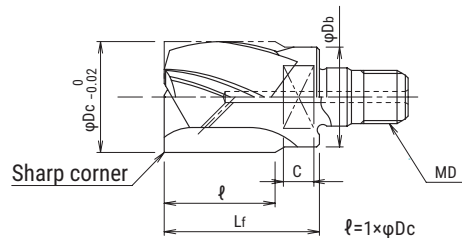
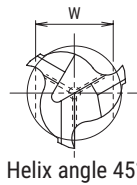

Cat.No.	Stock	No. of inserts	Dimensions (mm)					C	W
			φDc	ℓ	Lf	φDb	MD		
SMAL-3180-M8	●	3	18	18	26	15	M8	5.5	14
SMAL-3200-M10	●		20	20	28	18	M10		
SMAL-3220-M10	●		22	22	31	19	M12		17
SMAL-3250-M12	●		25	25	35	23			19
SMAL-3280-M12	●		28	28	38	24			22
SMAL-3320-M16	●		32	32	42	29	M16		27

PROPER MOUNTING OF S-HEAD

Use DIJET DS type spanner wrench to prevent over-tightening

Tightening torque



Tool dia φDc (mm)	Screw	Width Across Flat W (mm)	Cat. No.	Tightening torque
φ18	M8	14	DS-14	10~11N·m
φ20	M10	14	DS-14	10~16N·m
φ22	M10	17	DS-17	10~16N·m
φ25	M12	19	DS-19	15~20N·m
φ28	M12	22	DS-22	15~20N·m
φ32	M16	27	DS-27	20~25N·m

S-HEAD

SMSA Type

■ Recommended cutting conditions

● Shoulder milling

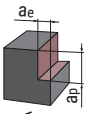
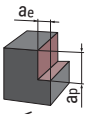
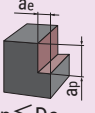
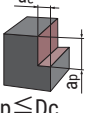
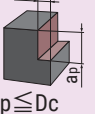
Material	Depth of cut 	Toll dia. (mm)											
		18		20		22		25		28		32	
		n (min ⁻¹)	Vf (mm/min)	n (min ⁻¹)	Vf (mm/min)	n (min ⁻¹)	Vf (mm/min)	n (min ⁻¹)	Vf (mm/min)	n (min ⁻¹)	Vf (mm/min)	n (min ⁻¹)	Vf (mm/min)
Aluminium alloy (A5052) 	$a_p \leq D_c$ $a_e \leq 0.05D_c$	3,200	800	2,800	700	2,600	650	2,300	570	2,050	510	1,800	450
Aluminium alloy (A7075) 	$a_p \leq D_c$ $a_e \leq 0.05D_c$	2,600	650	2,400	600	2,100	520	1,900	470	1,700	420	1,500	370
Aluminium alloy (Below Si 13%) 	$a_p \leq D_c$ $a_e \leq 0.05D_c$	3,200	800	2,800	700	2,600	650	2,300	570	2,050	510	1,800	450
Copper alloy (C1100) 	$a_p \leq D_c$ $a_e \leq 0.05D_c$	1,800	450	1,600	400	1,400	350	1,300	320	1,150	280	1,000	250

Note

1. Use water-soluble coolant.
2. Confirm appropriate gripping length of shank.
3. When ramping, apply 40~70% parameters from standard cutting conditions table.
4. Use rigid and accurate machine as possible.
5. If rpm available is lower than that recommended, reduce the feed rate proportionately.
6. Do not use higher rpm than that recommended.

■ Additional cutting conditions for longer tools

The percentages below should be applied, according to L/Dc.

1. Shoulder milling

L / Dc	n (min ⁻¹)	Vf (mm/min)	
~4Dc	0%	0%	-
5~6Dc	25% or below	30% or below	-
7~8Dc	40% or below	50% or below	Over Dc22 is not recommended

2. Slot milling

L / Dc	n (min ⁻¹)	Vf (mm/min)	ap
~4Dc	0%	0%	0.15Dc or below
5~6Dc	not recommended		
7~8Dc	not recommended		

S-HEAD **SMSR Type**

■ **SMSR Type**

Through coolant hole



Anti-Vibration Solid Carbide Head

- Unequal pitch & irregular helix achieves stable machining.
- Positive geometry and through coolant hole prevent material welding and gives excellent chip evacuation.
- Widely applied from carbon steel, mold steel, stainless steel & Ti-Alloy.

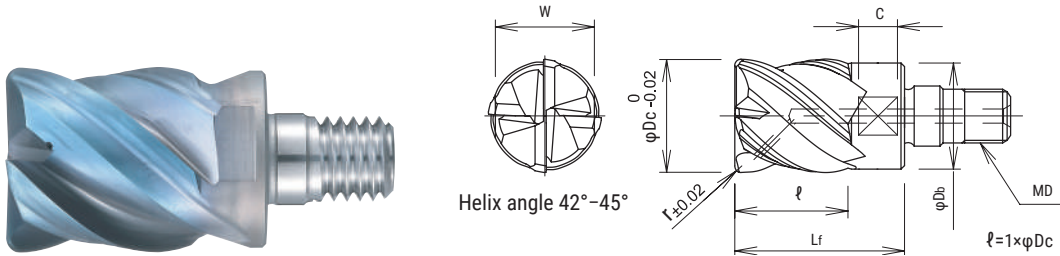

Cat.No.	Stock	No. of inserts	Dimensions (mm)							
			φDc	r	ℓ	Lf	φDb	MD	C	W
SMSR-4160R05-M8	●	4	16	0.5	16	24	15	M8	5.5	14
SMSR-4160R10-M8	●			1						
SMSR-4160R20-M8	●			2						
SMSR-4160R30-M8	●			3						
SMSR-4200R05-M10	●		20	0.5	20	29	19	M10		
SMSR-4200R10-M10	●			1						
SMSR-4200R20-M10	●			2						
SMSR-4200R30-M10	●		3							
SMSR-4250R10-M12	●		25	1	25	35	24	M12		
SMSR-4250R20-M12	●			2						
SMSR-4250R30-M12	●			3						
SMSR-4300R10-M16	●		30	1	30	44	29	M16		
SMSR-4300R20-M16	●			2						
SMSR-4300R30-M16	●			3						
SMSR-4320R10-M16	●		32	1	32	46	30			
SMSR-4320R20-M16	●			2						
SMSR-4320R30-M16	●	3								

PROPER MOUNTING OF S-HEAD

Use DIJET DS type spanner wrench to prevent over-tightening

Tightening torque



Tool dia φDc (mm)	Width Across Flat W (mm)	Cat. No.	Tightening torque
φ16	14	DS-14	10~11N·m
φ20	17	DS-17	10~16N·m
φ25	22	DS-22	15~20N·m
φ30	27	DS-27	20~25N·m
φ32	27	DS-27	20~25N·m

S-HEAD **SMSR Type**

■ Recommended cutting conditions

● Side cutting

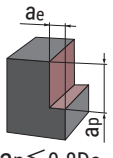
Material	Depth of cut 	Toll dia. (mm)								
		16			20			25		
		4N			4N			4N		
		ℓ (mm)	n (min ⁻¹)	V_f (mm/min)	ℓ (mm)	n (min ⁻¹)	V_f (mm/min)	ℓ (mm)	n (min ⁻¹)	V_f (mm/min)
Carbon steel (S50C, S55C) below 250HB	$a_p \leq 0.8D_c$ $a_e \leq 0.1D_c$	70	2,980	1,430	70	2,390	1,150	100	1,910	920
		110	2,690	1,230	125	2,150	980	150	1,720	780
		150	2,390	1,030	175	1,910	830	200	1,530	660
Mold steel (NAK80, HPM1, P21) 38-43HRC	$a_p \leq 0.8D_c$ $a_e \leq 0.1D_c$	70	2,390	1,150	70	1,910	920	100	1,530	730
		110	2,150	980	125	1,720	780	150	1,380	630
		150	1,910	830	175	1,530	660	200	1,220	530
Hardened die steel (SKD61, DAC, DHA) 42-52HRC	$a_p \leq 0.8D_c$ $a_e \leq 0.1D_c$	70	1,390	670	70	1,110	530	100	890	430
		110	1,250	570	125	1,000	460	150	800	360
		150	1,110	480	175	890	380	200	710	310
Austenitic stainless steel (SUS304, 316, 317)	$a_p \leq 0.8D_c$ $a_e \leq 0.1D_c$	70	1,990	960	70	1,590	760	100	1,270	610
		110	1,790	820	125	1,430	650	150	1,150	520
		150	1,590	690	175	1,270	550	200	1,020	440
Titanium alloy (Ti-6Al-4V) 35-43HRC	$a_p \leq 0.8D_c$ $a_e \leq 0.1D_c$	70	1,590	640	70	1,270	510	100	1,020	410
		110	1,430	540	125	1,150	440	150	920	350
		150	1,270	460	175	1,020	370	200	810	290
Heat resistant alloy (INCO718) 35-43HRC	$a_p \leq 0.8D_c$ $a_e \leq 0.1D_c$	70	990	200	70	800	160	100	640	130
		110	900	170	125	720	140	150	570	110
		150	800	140	175	640	120	200	510	90

■ Additional cutting conditions for longer tools

The percentages below should be applied, according to L/Dc.

L/D	n (min ⁻¹)	V _f (mm/min)	a _p (mm)	a _e (mm)
L ≤ 4D	0%	0%	0%	0%
4D < L ≤ 6D	20% reduction	30% reduction	0%	~0.05D _c
6D < L	30% reduction	50% reduction	~0.5D _c	~0.025D _c

Note: Do not use for slot milling

S-HEAD**SMSR Type**

■ Recommended cutting conditions

● Side cutting

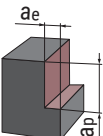
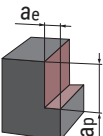
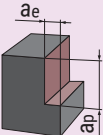
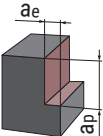
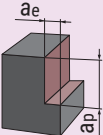
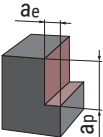
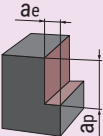
Material	Depth of cut 	Toll dia. (mm)								
		30			32					
		4N			4N					
φ (mm)	n (min ⁻¹)	V_f (mm/min)	φ (mm)	n (min ⁻¹)	V_f (mm/min)					
Carbon steel (S50C, S55C) below 250HB	 $a_p \leq 0.8D_c$ $a_e \leq 0.1D_c$	110	1,590	760	110	1,490	720			
		160	1,430	650	160	1,340	610			
		210	1,270	550	210	1,190	510			
Mold steel (NAK80, HPM1, P21) 38-43HRC	 $a_p \leq 0.8D_c$ $a_e \leq 0.1D_c$	110	1,270	610	110	1,190	570			
		160	1,150	520	160	1,070	490			
		210	1,020	440	210	950	410			
Hardened die steel (SKD61, DAC, DHA) 42-52HRC	 $a_p \leq 0.8D_c$ $a_e \leq 0.1D_c$	110	740	360	110	700	340			
		160	670	310	160	630	290			
		210	590	250	210	560	240			
Austenitic stainless steel (SUS304, 316, 317)	 $a_p \leq 0.8D_c$ $a_e \leq 0.1D_c$	110	1,060	510	110	990	480			
		160	950	430	160	900	410			
		210	850	370	210	800	350			
Titanium alloy (Ti-6Al-4V) 35-43HRC	 $a_p \leq 0.8D_c$ $a_e \leq 0.1D_c$	110	850	340	110	800	320			
		160	760	290	160	720	270			
		210	680	240	210	640	230			
Heat resistant alloy (INCO718) 35-43HRC	 $a_p \leq 0.8D_c$ $a_e \leq 0.1D_c$	110	530	110	110	500	100			
		160	480	90	160	450	90			
		210	420	80	210	400	70			

S-HEAD **SMHB Type**

■ **SMHB Type**



4 Flute Solid Carbide Ball Modular Head for hard or difficult to cut materials from roughing to finishing

- Unique blade shape with sub pocket in center of cutting edge allows stable machining & good chip evacuation.
- Torsional angles of the ball & peripheral flutes are increased to reduce cutting resistance & suppress vibration.

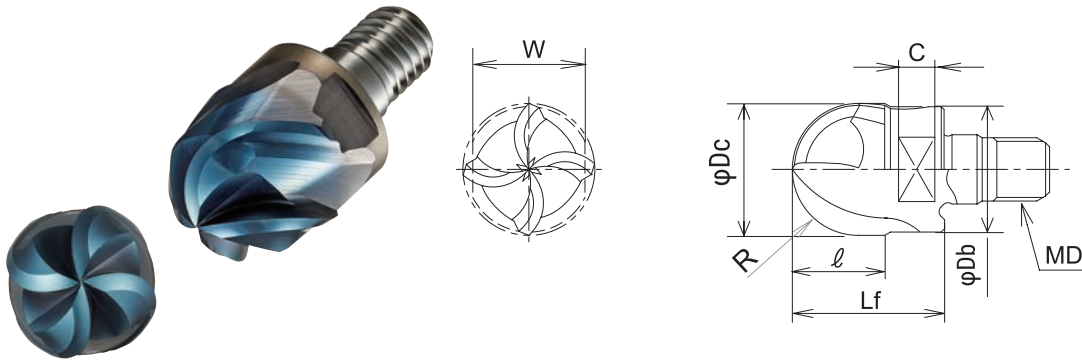

Cat.No.	Stock	No. of inserts	Dimensions (mm)							
			φDc	R	ℓ	Lf	φDb	MD	C	W
SMHB-4160-M8	●	4	16	8	11.2	19	15	M8	5.5	14
SMHB-4200-M10	●		20	10	14	23	19	M10		17

◆ **RECOMMENDED TIGHTENING TORQUE**

Tool Dia. φDc(mm)	Tightening torque	Width Across Flat W (mm)	Cat.No.
φ16	10~11N·m	14	DS-14
φ20	10~16N·m	17	DS-17

← Use DIJET DS type spanner wrench to prevent over-tightening

Radius tolerance (mm)

Radius	R tolerance
R8	±0.008
R10	±0.010

■ **Recommended cutting conditions**

■ **FINISHING**

Material	Carbon steel · Alloy steel	Hardened die steel (SKD61, DAC, DHA) 42~52HRC	Stainless steel · Heat resistant alloy 38~42HRC
Type of machining	 ap ≤ 0.03Dc ae ≤ 0.03Dc	 ap ≤ 0.03Dc ae ≤ 0.03Dc	 ap ≤ 0.03Dc ae ≤ 0.03Dc
Tool dia.	n (min ⁻¹) Vf (mm/min)	n (min ⁻¹) Vf (mm/min)	n (min ⁻¹) Vf (mm/min)
R 8 φ Dc 16	6,000 4,000	5,000 3,000	5,500 3,500
10 20	5,700 4,000	4,500 3,000	5,000 3,500

■ **SEMI-FINISHING · ROUGHING**

Material	Carbon steel · Alloy steel ~25HRC	Hardened die steel (SKD61, DAC, DHA) 42~52HRC	Stainless steel · Heat resistant alloy 38~42HRC
Type of machining	 ap ≤ 0.1Dc ae ≤ 0.25Dc	 ap ≤ 0.1Dc ae ≤ 0.25Dc	 ap ≤ 0.1Dc ae ≤ 0.25Dc
Tool dia.	n (min ⁻¹) Vf (mm/min)	n (min ⁻¹) Vf (mm/min)	n (min ⁻¹) Vf (mm/min)
R 8 φ Dc 16	4,500 3,000	3,800 2,200	4,200 2,600
10 20	4,300 3,000	3,400 2,200	3,800 2,600

Carbide Modular Head Holder MSN Type

■ Endmill Shank Type

Through coolant hole

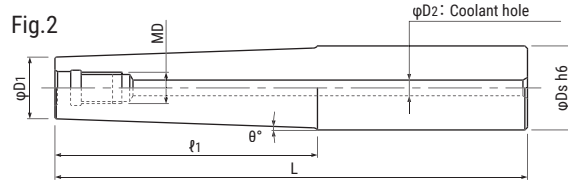
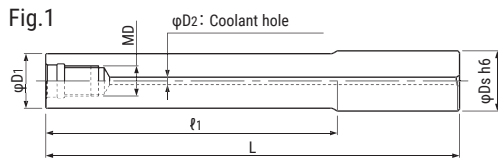

Cat.No.	Stock	Dimensions(mm)							Weight (kg)	Fig.
		ϕDs	$l1$	L	$\phi D1$	θ°	MD	$\phi D2$		
MSN-M6-12-S10C	●	10	2	60	9.7	-	M6	3	0.06	1
MSN-M6-15-S12C	●	12	15	60	11.5	-			0.08	1
MSN-M6-15-S16C	●	16	15	60	13.5	-			0.15	1
MSN-M6-30-S10C	●	10	30	80	9.7	-			0.07	1
MSN-M6-30-S12C	●	12	30	80	11.5	-			0.11	1
MSN-M6-30-S16C	●	16	30	80	13.5	-			0.19	1
MSN-M6-35T-S12C	●	12	35	92	9.5	1°30'			0.12	2
MSN-M6-50-S10C	●	10	50	100	9.7	-			0.09	1
MSN-M6-50-S12C	●	12	50	100	11.5	-			0.13	1
MSN-M6-50-S16C	●	16	50	100	13.5	-			0.23	1
MSN-M6-57T-S12C	●	12	57	114	9.5	1°			0.14	2
MSN-M6-65T-S16C	●	16	65	125	11.2	1°45'			0.28	2
MSN-M6-80-S10C	●	10	90	130	9.7	-			0.12	1
MSN-M6-80-S12C	●	12	90	130	11.5	-			0.18	1
MSN-M6-80-S16C	●	16	90	130	13.5	-	0.28	1		
MSN-M8-20-S16C	●	16	20	75	15.5	-	M8	4	0.17	1
MSN-M8-40-S16C	●	16	40	95	15.5	-			0.22	1
MSN-M8-40T-S20C	●	20	40	100	14.5	3°30'			0.36	2
MSN-M8-77T-S20C	●	20	77	143	14.5	1°45'			0.49	2
MSN-M8-80-S16C	●	16	80	135	15.5	-			0.32	1
MSN-M8-120-S16C	●	16	120	175	15.5	-			0.42	1
MSN-M8-152-S16C	●	16	152	207	15.5	-	0.51	1		
MSN-M10-20-S20C	●	20	20	80	19.5	-	M10	4	0.29	1
MSN-M10-40-S20C	●	20	40	100	19.5	-			0.39	1
MSN-M10-40T-S20C	●	20	40	100	18.5	0°43'			0.39	2
MSN-M10-70-S20C	●	20	70	130	19.5	-			0.50	1
MSN-M10-85T-S25C	●	25	85	161	18.5	2°			0.90	2
MSN-M10-90-S20C	●	20	90	150	19.5	-			0.60	1
MSN-M10-90T-S20C	●	20	90	150	18.5	0°19'			0.58	2
MSN-M10-140-S20C	●	20	140	200	19.5	-			0.80	1
MSN-M10-140T-S20C	●	20	140	200	18.5	0°12'			0.77	2
MSN-M10-160-S20C	●	20	160	220	19.5	-			0.87	1
MSN-M10-210-S20C	●	20	210	270	19.5	-	1.07	1		

Carbide Modular Head Holder

MSN Type

■ Endmill Shank Type

Through coolant hole

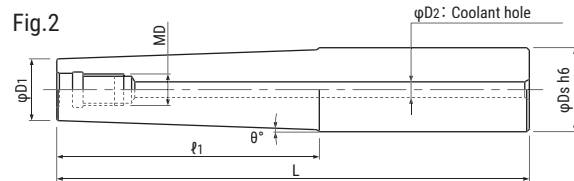
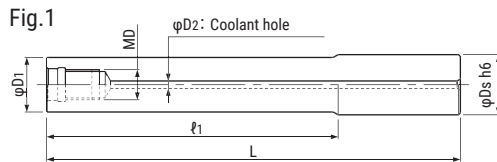

Cat.No.	Stock	Dimensions(mm)							Weight (kg)	Fig.
		φDs	l1	L	φD1	θ°	MD	φD2		
MSN-M12-25-S25C	●	25	25	90	24	-	M12	6	0.53	1
MSN-M12-55-S25C	●	25	55	120	24	-			0.72	1
MSN-M12-100T-S32C	●	32	100	180	23.5	2°			1.61	2
MSN-M12-105-S25C	●	25	105	170	24	-			1.03	1
MSN-M12-135-S25C	●	25	135	215	24	-			1.30	1
MSN-M12-155-S25C	●	25	155	220	24	-			1.34	1
MSN-M12-200-S25C	●	25	200	265	24	1°30'			1.58	1
MSN-M16-25-S32C	●	32	25	90	29	-			M16	8
MSN-M16-55-S32C	●	32	55	120	29	-	1.13	1		
MSN-M16-77-S32C	●	32	77	157	29	-	1.47	1		
MSN-M16-97-S32C	●	32	97	177	29	-	1.64	1		
MSN-M16-105-S32C	●	32	105	170	29	-	1.59	1		
MSN-M16-117T-S32C	●	32	117	197	29	0°38'	1.88	2		
MSN-M16-127-S32C	●	32	127	207	29	-	1.89	1		
MSN-M16-127T-S32C	●	32	127	207	29	0°30'	2.23	2		
MSN-M16-155-S32C	●	32	155	220	29	-	2.04	1		
MSN-M16-177-S32C	●	32	177	257	29	-	2.32	1		
MSN-M16-177T-S32C	●	32	177	257	29	0°23'	2.78	2		
MSN-M16-195-S32C	●	32	195	260	29	-	2.40	1		
MSN-M16-197T-S32C	●	32	197	277	29	0°23'	3.00	2		
MSN-M16-225-S32C	●	32	225	290	29	-	2.57	1		
MSN-M16-245-S32C	●	32	245	310	29	-	2.74	1		
MSN-M16-295-S32C	●	32	295	360	29	-	3.17	1		

Carbide Modular Head Holder MSN Type

■ Straight Type

Through coolant hole

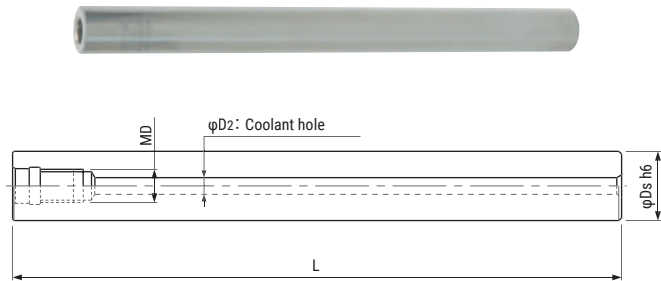

Cat.No.	Stock	Dimensions(mm)				Weight (kg)
		φDs	L	MD	φD2	
MSN-M6-67S-S9.8C	●	9.8	67	M6	3	0.06
MSN-M6-107S-S9.8C	●	9.8	107		3	0.10
MSN-M6-82S-S10C	●	10	82		3	0.08
MSN-M6-122S-S10C	●	10	122		3	0.12
MSN-M6-80S-S11.8C	●	11.8	80		3	0.11
MSN-M6-120S-S11.8C	●	11.8	120		3	0.17
MSN-M6-90S-S12C	●	12	90		3	0.13
MSN-M6-130S-S12C	●	12	130		3	0.19
MSN-M8-87S-S14C	●	14	87		M8	4
MSN-M8-137S-S14C	●	14	137	4		0.26
MSN-M8-97S-S15C	●	15	97	4		0.21
MSN-M8-147S-S15C	●	15	147	4		0.33
MSN-M8-197S-S15C	●	15	197	4		0.44
MSN-M8-107S-S16C	●	16	107	4		0.27
MSN-M8-157S-S16C	●	16	157	4		0.40
MSN-M10-130S-S18C	●	18	130	M10	4	0.42
MSN-M10-190S-S18C	●	18	190		4	0.62
MSN-M10-240S-S18C	●	18	240		4	0.89
MSN-M10-130S-S20C	●	20	130		4	0.53
MSN-M10-190S-S20C	●	20	190		4	0.78
MSN-M10-250S-S20C	●	20	250	4	1.02	
MSN-M12-185S-S23C	●	23	185	M12	6	0.98
MSN-M12-265S-S23C	●	23	265		6	1.42
MSN-M12-185S-S24C	●	24	185		6	1.07
MSN-M12-265S-S24C	●	24	265		6	1.54
MSN-M12-145S-S25C	●	25	145		6	0.91
MSN-M12-215S-S25C	●	25	215		6	1.36
MSN-M12-285S-S25C	●	25	285		6	1.80
MSN-M16-160S-S28C	●	28	160	M16	8	1.22
MSN-M16-230S-S28C	●	28	230		8	1.77
MSN-M16-310S-S28C	●	28	310		8	2.41
MSN-M16-157S-S32C	●	32	157		8	1.61
MSN-M16-217S-S32C	●	32	217		8	2.22
MSN-M16-287S-S32C	●	32	287		8	2.94
MSN-M16-357S-S32C	●	32	357		8	3.66



DRILLS

EZ HARD DRLL **EZH Type**

Feature 1

DH1 coating with high fracture toughness carbide substrate delivers stable drilling for high hardened materials up to 70HRC

Feature 2

Increased rigidity

Feature 3

Excellent breaking resistance

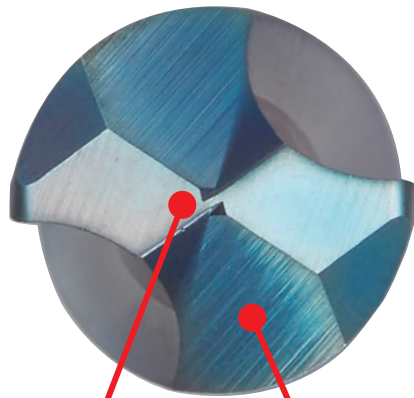

Optimized geometry specially for hardened materials

Larger web thickness

	DH1 coating	DV coating	DZ coating
Hardness (Hv)	3,500~3,700	3,300~3,500	2,800~2,900
Oxidization temperature (°C)	1,100~1,200	1,000~1,100	700~800
Coefficient of friction	0.5	0.65	0.6

EZ HARD DRILL **EZH/EZH-LS Type**

■ **EZH Type**

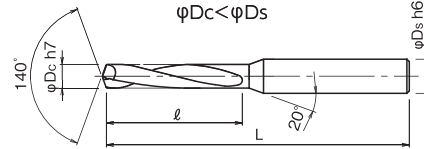
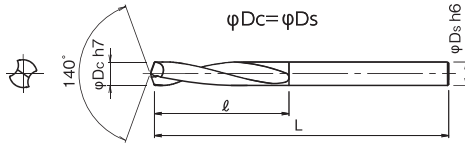

Cat. No.	Stock	Dimensions (mm)			
		φDc	ℓ	L	φDs
EZH5D0200S03	●	2	16	55	3
EZH5D0200S03-12	●	2	12	55	3
EZH5D0200S03-21	●	2	21	55	3
EZH5D0210S03	●	2.1	16	55	3
EZH5D0220S03	●	2.2	16	55	3
EZH5D0230S03	●	2.3	16	55	3
EZH5D0240S03	●	2.4	16	55	3
EZH5D0250S03	●	2.5	16	55	3
EZH5D0250S03-21	●	2.5	21	55	3
EZH5D0260S03	●	2.6	16	55	3
EZH5D0270S03	●	2.7	16	55	3
EZH5D0280S03	●	2.8	16	55	3
EZH5D0290S03	●	2.9	16	55	3
EZH5D0300S04	●	3	21	59	4
EZH5D0330S04	●	3.3	24	59	4
EZH5D0340S04	●	3.4	24	59	4
EZH5D0350S04	●	3.5	24	59	4
EZH5D0380S04	●	3.8	27	59	4
EZH5D0390S04	●	3.9	27	59	4
EZH5D0400S04	●	4	27	59	4
EZH5D0420S06	●	4.2	29	74	6
EZH5D0430S06	●	4.3	29	74	6
EZH5D0440S06	●	4.4	29	74	6
EZH5D0450S06	●	4.5	29	74	6

Cat. No.	Stock	Dimensions (mm)			
		φDc	ℓ	L	φDs
EZH5D0490S06	●	4.9	32	74	6
EZH5D0500S06	●	5	32	74	6
EZH5D0510S06	●	5.1	34	79	6
EZH5D0520S06	●	5.2	34	79	6
EZH5D0590S06	●	5.9	36	79	6
EZH5D0600S06	●	6	41	79	6
EZH5D0680S08	●	6.8	43	88	8
EZH5D0690S08	●	6.9	43	88	8
EZH5D0700S08	●	7	43	88	8
EZH5D0790S08	●	7.9	48	93	8
EZH5D0800S08	●	8	48	93	8
EZH5D0850S10	●	8.5	53	98	10
EZH5D0860S10	●	8.6	55	98	10
EZH5D0900S10	●	9	55	98	10
EZH5D0990S10	●	9.9	60	108	10
EZH5D1000S10	●	10	60	108	10
EZH5D1030S12	●	10.3	66	117	12
EZH5D1040S12	●	10.4	66	117	12
EZH5D1100S12	●	11	68	117	12
EZH5D1190S12	●	11.9	73	117	12
EZH5D1200S12	●	12	73	117	12

■ **EZH-LS type**



Cat. No.	Stock	Dimensions (mm)			
		φDc	ℓ	L	φDs
EZH5D0300S04-LS	●	3	25	69	4
EZH5D0330S04-LS	●	3.3	25	79	4
EZH5D0380S04-LS	●	3.8	30	79	4
EZH5D0400S04-LS	●	4	30	79	4

Drill dia.	Tolerance
Dc ≤ 3	0 -0.01
3 < Dc ≤ 6	0 -0.012
6 < Dc ≤ 10	0 -0.015
10 < Dc ≤ 18	0 -0.018

EZ HARD DRILL**EZH Type**

■ Recommended cutting conditions

Material	Hardened steel (SKD61, DAC, DHA) 48~56HRC		Hardened steel (SKD11, SLD, DC11) 57~62HRC		HSS (SKH, HAP) 63~70HRC	
	Vc (m/min)	f (mm/rev)	n (min ⁻¹)	Vf (mm/min)	n (min ⁻¹)	Vf (mm/min)
Vc (m/min)	15~20 (φ 2) 15~25 (φ 2.5~φ12) 10~20 (φ13 ~φ16)		10~15 (φ 2~φ12) 7~13 (φ13~φ16)		5~10 (φ 2) 7~12 (φ 2.5~φ12) 6~10 (φ13 ~φ16)	
f (mm/rev)	0.03~0.05 (φ 3~φ 4) 0.04~0.06 (φ 5) 0.06~0.08 (φ 6~φ 7) 0.06~0.09 (φ 8~φ 9) 0.06~0.10 (φ10~φ11) 0.07~0.12 (φ12~φ16)		0.03~0.05 (φ 2~φ 4) 0.04~0.06 (φ 5) 0.05~0.07 (φ 6~φ 7) 0.05~0.08 (φ 8~φ 9) 0.05~0.09 (φ10~φ11) 0.05~0.10 (φ12~φ13) 0.07~0.12 (φ14~φ16)		0.02~0.04 (φ 2~φ 4) 0.03~0.05 (φ 5) 0.04~0.06 (φ 6~φ 9) 0.04~0.07 (φ10~φ11) 0.05~0.08 (φ12~φ13) 0.06~0.09 (φ14~φ16)	
Dc (mm)	n (min ⁻¹)	Vf (mm/min)	n (min ⁻¹)	Vf (mm/min)	n (min ⁻¹)	Vf (mm/min)
2	2,860	115	2,070	86	1,270	38
2.5	2,550	102	1,660	66	1,270	38
3	2,100	84	1,380	55	1,060	31
4	1,590	63	1,035	41	795	23
5	1,270	62	830	41	635	25
6	1,060	74	690	41	530	26
7	910	63	590	35	455	22
8	795	60	520	34	400	20
9	710	54	460	30	355	18
10	640	51	415	29	320	17
11	580	46	375	26	290	16
12	530	47	345	26	265	16
13	370	33	250	20	200	13
14	330	30	220	20	180	13
15	320	30	210	20	170	13
16	320	30	200	19	160	12

Drilling depth : 3Dc

Note

1. Use water soluble coolant.
2. Not recommended for use on non-heat treated material.
3. Recommended for material over 50 HR to 70 HRC.
4. Use on rigid machine with a precision holder.
5. Above data recommended for cutting depth of 3XD. Peck drilling is recommended if drilling deeper than 3xD.
6. Recommended for drilling blind hole, if drilling thru hole, use back up material underneath.
7. If using -LS type, reduce above data.

FLAT DRILL **TLDM Type**

■ TLDM 2D Type

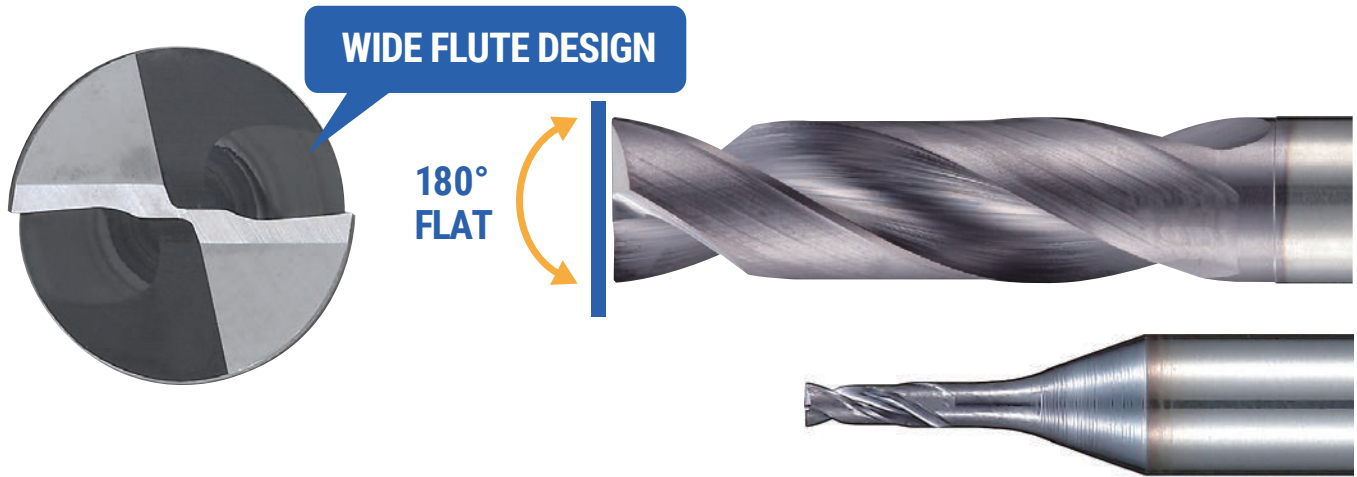
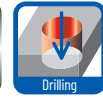

Applications

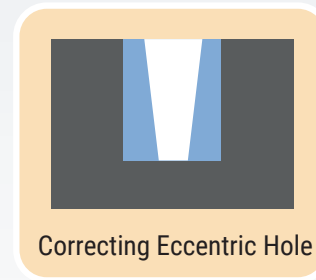
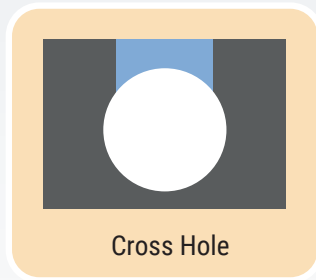
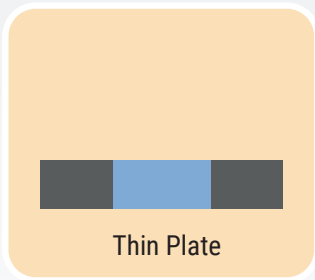
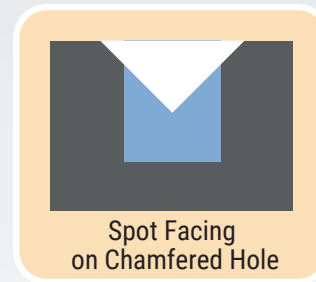
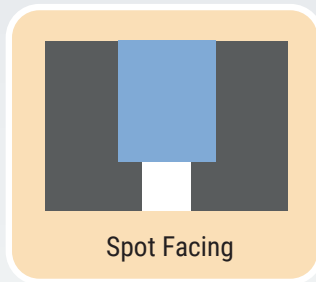
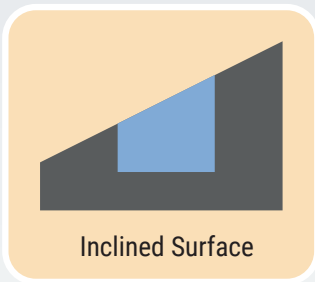

Material	Structural steel	Carbon steel	Alloy steel	Mold steel	Hardened steel (~50HRC)	Titanium alloy	Heat resistant alloy	Stainless steel	Cast iron	Aluminium alloy
	SS400	S50C	SCM440	NAK80	SKD61	Ti-6Al-4V	INCO718	SUS304	FC/FCD	AC/ADC
	◎	◎	◎	◎	○	○	○	◎	◎	○

◎: Excellent ○: Good

FLAT DRILL **TLDM Type**

■ TLDM 2D Type

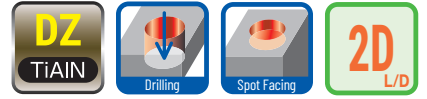

Cat.No	Stock	Dimension(mm)					
		φDc	ℓ	L	φDs		
TLDM010	●	1	3	60	3		
TLDM011	●	1.1	3.3				
TLDM012	●	1.2	3.6				
TLDM013	●	1.3	3.9				
TLDM014	●	1.4	4.2				
TLDM015	●	1.5	4.5				
TLDM016	●	1.6	4.8				
TLDM017	●	1.7	5.1				
TLDM018	●	1.8	5.4				
TLDM019	●	1.9	5.7				
TLDM020	●	2	7				
TLDM021	●	2.1	7.5				
TLDM022	●	2.2	8				
TLDM023	●	2.3	8.5				
TLDM024	●	2.4	9				
TLDM025	●	2.5	9.5				
TLDM026	●	2.6	10				
TLDM027	●	2.7	10.5				
TLDM028	●	2.8	11				
TLDM029	●	2.9	11.5				
TLDM030	●	3	12	60	4		
TLDM030-S6	●						
TLDM031	●	3.1				12	6
TLDM031-S6	●						
TLDM032	●	3.2				12	4
TLDM032-S6	●						
TLDM033	●	3.3				13	4
TLDM033-S6	●						
TLDM034	●	3.4				13	6
TLDM034-S6	●						
TLDM035	●	3.5	13	4			
TLDM035-S6	●						
TLDM036	●	3.6	14	4			
TLDM036-S6	●						
TLDM037	●	3.7	14	6			
TLDM037-S6	●						
TLDM038	●	3.8	15	4			
TLDM038-S6	●						

Cat.No	Stock	Dimension(mm)			
		φDc	ℓ	L	φDs
TLDM039	●	3.9	15	60	4
TLDM039-S6	●				6
TLDM040	●	4	16	60	4
TLDM040-S6	●				4
TLDM041	●	4.1	16	60	6
TLDM042	●				
TLDM043	●	4.3	17	60	6
TLDM044	●				
TLDM045	●	4.5	17	60	6
TLDM046	●				
TLDM047	●	4.7	18	65	6
TLDM048	●				
TLDM049	●	4.9	19	65	6
TLDM050	●				
TLDM051	●	5.1	20	65	6
TLDM052	●				
TLDM053	●	5.3	21	65	6
TLDM054	●				
TLDM055	●	5.5	21	65	6
TLDM056	●				
TLDM057	●	5.7	22	70	6
TLDM058	●				
TLDM059	●	5.9	23	70	6
TLDM060	●				
TLDM061	●	6.1	24	70	6
TLDM062	●				
TLDM063	●	6.3	24	70	6
TLDM064	●				
TLDM065	●	6.5	25	70	6
TLDM066	●				
TLDM067	●	6.7	26	75	8
TLDM068	●				
TLDM069	●	6.9	26	75	8
TLDM070	●				
TLDM071	●	7.1	27	75	8
TLDM072	●				
TLDM073	●	7.3	28	75	8
TLDM074	●				

FLAT DRILL **TLDM Type**

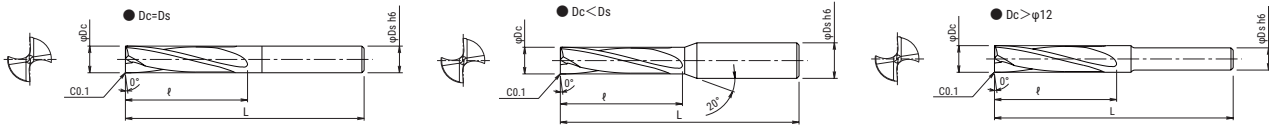

Cat.No	Stock	Dimension(mm)			
		φDc	ℓ	L	φDs
TLDM075	●	7.5	29	75	8
TLDM076	●	7.6			
TLDM077	●	7.7	30		
TLDM078	●	7.8			
TLDM079	●	7.9			
TLDM080	●	8	31		
TLDM081	●	8.1			
TLDM082	●	8.2	32		
TLDM083	●	8.3			
TLDM084	●	8.4			
TLDM085	●	8.5			
TLDM086	●	8.6	33		
TLDM087	●	8.7			
TLDM088	●	8.8			
TLDM089	●	8.9	34		
TLDM090	●	9			
TLDM091	●	9.1	80	10	
TLDM092	●	9.2			
TLDM093	●	9.3			36
TLDM094	●	9.4			
TLDM095	●	9.5			37
TLDM096	●	9.6			
TLDM097	●	9.7			38
TLDM098	●	9.8			
TLDM099	●	9.9			
TLDM100	●	10			39
TLDM101	●	10.1			
TLDM102	●	10.2	40		
TLDM103	●	10.3			
TLDM104	●	10.4			
TLDM105	●	10.5			
TLDM106	●	10.6	41		
TLDM107	●	10.7			
TLDM108	●	10.8	42		
TLDM109	●	10.9			
TLDM110	●	11			

Cat.No	Stock	Dimension(mm)			
		φDc	ℓ	L	φDs
TLDM111	●	11.1	43	85	12
TLDM112	●	11.2			
TLDM113	●	11.3	44		
TLDM114	●	11.4			
TLDM115	●	11.5			
TLDM116	●	11.6	45	90	
TLDM117	●	11.7			
TLDM118	●	11.8			
TLDM119	●	11.9	46	100	
TLDM120	●	12			
TLDM125	●	12.5	48		
TLDM130	●	13	50		
TLDM135	●	13.5	52		
TLDM140	●	14	54		

Drill dia.	Tolerance
Dc ≤ 3	0
	-0.01
3 < Dc ≤ 6	0
	-0.012
6 < Dc ≤ 10	0
	-0.015
10 < Dc ≤ 18	0
	-0.018

FLAT DRILL**TLDM Type****Recommended cutting conditions**

Material	Structural steel (SS400) below 180HB		Carbon steel (S50C) below 280HB		Alloy steel (SCM440) 280~350HB	
Vc (m/min)	50~100		50~100		30~70	
f (mm/rev)	0.01~0.05 (φ1~φ2) 0.06~0.24 (φ3~φ14)		0.01~0.05 (φ1~φ2) 0.06~0.24 (φ3~φ14)		0.01~0.04 (φ1~φ2) 0.06~0.24 (φ3~φ14)	
Dc (mm)	n (min ⁻¹)	Vf (mm/min)	n (min ⁻¹)	Vf (mm/min)	n (min ⁻¹)	Vf (mm/min)
1	19,100	380	19,100	380	12,700	250
2	11,100	380	11,100	380	8,000	250
3	8,500	510	8,500	510	6,375	380
4	6,375	510	6,375	510	4,775	380
5	5,100	510	5,100	510	3,825	380
6	4,250	510	4,250	510	3,175	380
7	3,650	510	3,650	510	2,725	380
8	3,175	510	3,175	510	2,375	380
9	2,825	510	2,825	510	2,125	380
10	2,550	510	2,550	510	1,900	380
11	2,325	465	2,325	465	1,725	345
12	2,125	425	2,125	425	1,600	320
13	1,950	390	1,950	390	1,475	295
14	1,825	365	1,825	365	1,375	275

Material	Mold steel (NAK80) 38~43HRC		Hardened steel (SKD61) below 50HRC		Titanium alloy (Ti-6Al-4V) 30~42HRC	
Vc (m/min)	20~40 (φ1~φ2) 20~50 (φ3~φ14)		15~30		20~40 (φ1~φ2) 20~50 (φ3~φ14)	
f (mm/rev)	0.005~0.03 (φ1~φ2) 0.06~0.20 (φ3~φ14)		0.005~0.03 (φ1~φ2) 0.03~0.12 (φ3~φ14)		0.005~0.03 (φ1~φ2) 0.06~0.20 (φ3~φ14)	
Dc (mm)	n (min ⁻¹)	Vf (mm/min)	n (min ⁻¹)	Vf (mm/min)	n (min ⁻¹)	Vf (mm/min)
1	9,500	100	6,400	50	9,500	100
2	4,800	100	3,200	50	4,800	100
3	3,175	320	2,125	100	3,175	320
4	2,375	240	1,600	80	2,375	240
5	1,900	200	1,275	70	1,900	200
6	1,600	170	1,050	60	1,600	170
7	1,375	150	900	60	1,375	150
8	1,200	140	800	50	1,200	140
9	1,050	120	700	50	1,050	120
10	950	110	625	50	950	110
11	875	110	575	50	875	110
12	800	100	525	40	800	100
13	725	90	500	40	725	90
14	675	90	450	40	675	90

Note

1. These cutting conditions are for drilling flat surface. For inclined angle under 30°, Apply 40-80% (Vf) from standard cutting conditions. For inclined surface over 30° or more, Apply 20-50% (Vf) from standard cutting conditions.
2. These cutting conditions are for drilling with water soluble coolant. In case of dry cutting, use air to remove the chips.
3. Drilling over 2xDc is not recommended.
4. Side milling is not possible.
5. Use 0.5mm step feed for drilling Heat-resistant alloys.
6. In case of long chips, adjust above conditions by increasing Feed speed (Vf) or using step feed for breaking chips.

FLAT DRILL**TLDM Type****Recommended cutting conditions**

Material	Heat resistant alloy (INCO718) 30~42HRC		Stainless steel (SUS304) belwo 280HB		Grey cast iron (FC250) below 350MPa	
Vc (m/min)	10~20		10~40 (φ1~φ2) 10~50 (φ3~φ14)		50~100	
f (mm/rev)	0.005~0.03 (φ1~φ2) 0.01~0.04 (φ3~φ14)		0.005~0.03 (φ1~φ2) 0.06~0.20 (φ3~φ14)		0.01~0.05 (φ1~φ2) 0.06~0.24 (φ3~φ14)	
Dc (mm)	n (min ⁻¹)	Vf (mm/min)	n (min ⁻¹)	Vf (mm/min)	n (min ⁻¹)	Vf (mm/min)
1	3,800	38	9,500	100	19,100	380
2	1,900	19	4,800	100	11,100	380
3	1,275	26	3,175	320	8,500	510
4	950	19	2,375	240	6,375	510
5	775	16	1,900	200	5,100	510
6	625	13	1,600	170	4,250	510
7	550	11	1,375	150	3,650	510
8	475	10	1,200	140	3,175	510
9	425	9	1,050	120	2,825	510
10	375	8	950	110	2,550	510
11	350	7	875	110	2,325	465
12	325	7	800	100	2,125	425
13	300	6	725	90	1,950	390
14	275	6	675	90	1,825	365

Material	Ductile cast iron (FCD400) below450MPa		Alminium alloy			
Vc (m/min)	50~100		50~150			
f (mm/rev)	0.01~0.05 (φ1~φ2) 0.06~0.24 (φ3~φ14)		0.01~0.08 (φ1~φ2) 0.06~0.24 (φ3~φ14)			
Dc (mm)	n (min ⁻¹)	Vf (mm/min)	n (min ⁻¹)	Vf (mm/min)		
1	19,100	380	25,500	800		
2	11,100	380	15,900	800		
3	8,500	510	12,725	770		
4	6,375	510	9,550	770		
5	5,100	510	7,650	770		
6	4,250	510	6,375	770		
7	3,650	510	5,450	770		
8	3,175	510	4,775	770		
9	2,825	510	4,250	770		
10	2,550	510	3,825	770		
11	2,325	465	3,475	695		
12	2,125	425	3,175	635		
13	1,950	390	2,950	590		
14	1,825	365	2725	545		

- Note
1. These cutting conditions are for drilling flat surface. For inclined angle under 30°, Apply 40-80% (Vf) from standard cutting conditions. For inclined surface over 30° or more, Apply 20-50% (Vf) from standard cutting conditions.
 2. These cutting conditions are for drilling with water soluble coolant. In case of dry cutting, use air to remove the chips.
 3. Drilling over 2xDc is not recommended.
 4. Side milling is not possible.
 5. Use 0.5mm step feed for drilling Heat-resistant alloys.
 6. In case of long chips, adjust above conditions by increasing Feed speed (Vf) or using step feed for breaking chips.

FLAT DRILL **TLD3D/TLD5D Type**

Feature 1
High hole accuracy

Through coolant hole

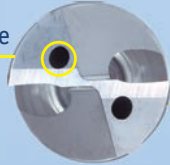

Unique geometry for firmly engaging the surface for high positioning accuracy

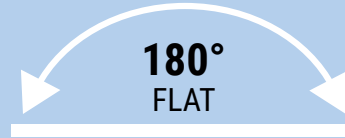

Feature 2
Capable of a wide range of applications such as spot facing on slope, correction of eccentric holes, and thin plate machining.

DOUBLE MARGIN

Feature 3
Double margin allows high precision straight drilling.

Feature 4
DV coating which has perfect balance between fracture & wear resistance and Smooth treatment on surface of drill ensure excellent tool life.

Feature 5
Applicable for a wide range of work materials; Carbon steel, Tool steel, Mould steel, Stainless steel, Cast iron and Aluminium.

Applications

Inclined Surface	Spot Facing	Spot Facing on Chamfered Hole
Thin Plate	Cross Hole	Correcting Eccentric Hole



FLAT DRILL

TLD3D Type

■ TLD3D Type

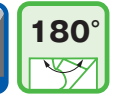

Cat.No	Stock	Dimension(mm)				
		φDc	ℓ	L	φDs	
TLD3DCH0300S03	●	3	14	60	3	
TLD3DCH0310S04	●	3.1				
TLD3DCH0320S04	●	3.2	15			
TLD3DCH0330S04	●	3.3				
TLD3DCH0340S04	●	3.4	16			
TLD3DCH0350S04	●	3.5				
TLD3DCH0360S04	●	3.6	17			
TLD3DCH0370S04	●	3.7				
TLD3DCH0380S04	●	3.8	18			
TLD3DCH0390S04	●	3.9				
TLD3DCH0400S04	●	4	19	65	5	
TLD3DCH0410S05	●	4.1				
TLD3DCH0420S05	●	4.2				
TLD3DCH0430S05	●	4.3				20
TLD3DCH0440S05	●	4.4				
TLD3DCH0450S05	●	4.5				21
TLD3DCH0460S05	●	4.6				
TLD3DCH0470S05	●	4.7				22
TLD3DCH0480S05	●	4.8				
TLD3DCH0490S05	●	4.9				23
TLD3DCH0500S05	●	5				
TLD3DCH0510S06	●	5.1	24	70	6	
TLD3DCH0520S06	●	5.2				
TLD3DCH0530S06	●	5.3				
TLD3DCH0540S06	●	5.4				25
TLD3DCH0550S06	●	5.5				
TLD3DCH0560S06	●	5.6				26
TLD3DCH0570S06	●	5.7				
TLD3DCH0580S06	●	5.8				27
TLD3DCH0590S06	●	5.9				
TLD3DCH0600S06	●	6				28
TLD3DCH0610S07	●	6.1				
TLD3DCH0620S07	●	6.2				

Cat.No	Stock	Dimension(mm)			
		φDc	ℓ	L	φDs
TLD3DCH0630S07	●	6.3	29	75	7
TLD3DCH0640S07	●	6.4			
TLD3DCH0650S07	●	6.5	30		
TLD3DCH0660S07	●	6.6			
TLD3DCH0670S07	●	6.7	31		
TLD3DCH0680S07	●	6.8			
TLD3DCH0690S07	●	6.9	32		
TLD3DCH0700S07	●	7			
TLD3DCH0710S08	●	7.1	33		
TLD3DCH0720S08	●	7.2			
TLD3DCH0730S08	●	7.3	34		
TLD3DCH0740S08	●	7.4			
TLD3DCH0750S08	●	7.5	35		
TLD3DCH0760S08	●	7.6			
TLD3DCH0770S08	●	7.7	36		
TLD3DCH0780S08	●	7.8			
TLD3DCH0790S08	●	7.9	37		
TLD3DCH0800S08	●	8			
TLD3DCH0810S09	●	8.1	38		
TLD3DCH0820S09	●	8.2			
TLD3DCH0830S09	●	8.3	39		
TLD3DCH0840S09	●	8.4			
TLD3DCH0850S09	●	8.5	40		
TLD3DCH0860S09	●	8.6			
TLD3DCH0870S09	●	8.7	41		
TLD3DCH0880S09	●	8.8			
TLD3DCH0890S09	●	8.9	42		
TLD3DCH0900S09	●	9			
TLD3DCH0910S10	●	9.1	43		
TLD3DCH0920S10	●	9.2			
TLD3DCH0930S10	●	9.3	95	10	
TLD3DCH0940S10	●	9.4			
TLD3DCH0950S10	●	9.5			

FLAT DRILL

TLD3D Type

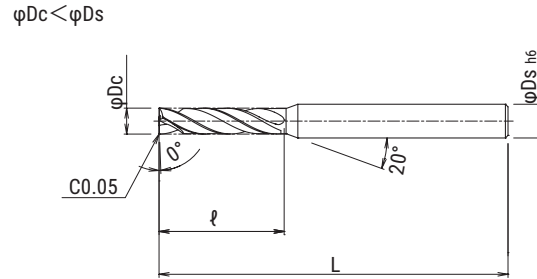
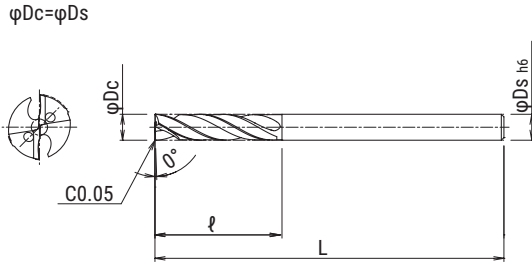

Cat.No	Stock	Dimension(mm)			
		φDc	ℓ	L	φDs
TLD3DCH0960S10	●	9.6	44	95	10
TLD3DCH0970S10	●	9.7			
TLD3DCH0980S10	●	9.8	45	105	11
TLD3DCH0990S10	●	9.9			
TLD3DCH1000S10	●	10	46	115	12
TLD3DCH1010S11	●	10.1			
TLD3DCH1020S11	●	10.2	47	125	13
TLD3DCH1030S11	●	10.3			
TLD3DCH1040S11	●	10.4	48	130	14
TLD3DCH1050S11	●	10.5			
TLD3DCH1060S11	●	10.6	49	130	14
TLD3DCH1070S11	●	10.7			
TLD3DCH1080S11	●	10.8	50	130	14
TLD3DCH1090S11	●	10.9			
TLD3DCH1100S11	●	11	51	130	14
TLD3DCH1110S12	●	11.1			
TLD3DCH1120S12	●	11.2	52	130	14
TLD3DCH1130S12	●	11.3			
TLD3DCH1140S12	●	11.4	53	130	14
TLD3DCH1150S12	●	11.5			
TLD3DCH1160S12	●	11.6	54	130	14
TLD3DCH1170S12	●	11.7			
TLD3DCH1180S12	●	11.8	57	125	13
TLD3DCH1190S12	●	11.9			
TLD3DCH1200S12	●	12	59	130	14
TLD3DCH1250S13	●	12.5			
TLD3DCH1300S13	●	13	61	130	14
TLD3DCH1350S14	●	13.5			
TLD3DCH1400S14	●	14	63	130	14

Drill dia.	Tolerance
$D_c \leq 3$	0
	-0.01
$3 < D_c \leq 6$	0
	-0.012
$6 < D_c \leq 10$	0
	-0.015
$10 < D_c \leq 18$	0
	-0.018

FLAT DRILL

TLD5D Type

■ TLD5D Type



Cat.No	Stock	Dimension(mm)			
		φDc	ℓ	L	φDs
TLD5DCH0300S03	●	3	20	70	3
TLD5DCH0310S04	●	3.1	21		4
TLD5DCH0320S04	●	3.2	22		
TLD5DCH0330S04	●	3.3			
TLD5DCH0340S04	●	3.4	23		
TLD5DCH0350S04	●	3.5	24		
TLD5DCH0360S04	●	3.6			
TLD5DCH0370S04	●	3.7	25		
TLD5DCH0380S04	●	3.8	26		
TLD5DCH0390S04	●	3.9			
TLD5DCH0400S04	●	4	27	80	5
TLD5DCH0410S05	●	4.1	28		
TLD5DCH0420S05	●	4.2			
TLD5DCH0430S05	●	4.3	29		
TLD5DCH0440S05	●	4.4	30		
TLD5DCH0450S05	●	4.5			
TLD5DCH0460S05	●	4.6	31		
TLD5DCH0470S05	●	4.7	32		
TLD5DCH0480S05	●	4.8			
TLD5DCH0490S05	●	4.9	33		
TLD5DCH0500S05	●	5	34		
TLD5DCH0510S06	●	5.1			
TLD5DCH0520S06	●	5.2	35		
TLD5DCH0530S06	●	5.3	36		
TLD5DCH0540S06	●	5.4			
TLD5DCH0550S06	●	5.5	37		
TLD5DCH0560S06	●	5.6	38		
TLD5DCH0570S06	●	5.7			
TLD5DCH0580S06	●	5.8	39		
TLD5DCH0590S06	●	5.9	40		
TLD5DCH0600S06	●	6			
TLD5DCH0610S07	●	6.1	41	85	6
TLD5DCH0620S07	●	6.2	42		

Cat.No	Stock	Dimension(mm)					
		φDc	ℓ	L	φDs		
TLD5DCH0630S07	●	6.3	42	95	7		
TLD5DCH0640S07	●	6.4	43				
TLD5DCH0650S07	●	6.5	44				
TLD5DCH0660S07	●	6.6					
TLD5DCH0670S07	●	6.7	45				
TLD5DCH0680S07	●	6.8	46				
TLD5DCH0690S07	●	6.9					
TLD5DCH0700S07	●	7	47				
TLD5DCH0710S08	●	7.1	48				
TLD5DCH0720S08	●	7.2					
TLD5DCH0730S08	●	7.3	49	100	8		
TLD5DCH0740S08	●	7.4	50				
TLD5DCH0750S08	●	7.5					
TLD5DCH0760S08	●	7.6	51				
TLD5DCH0770S08	●	7.7	52				
TLD5DCH0780S08	●	7.8					
TLD5DCH0790S08	●	7.9	53				
TLD5DCH0800S08	●	8	54				
TLD5DCH0810S09	●	8.1					
TLD5DCH0820S09	●	8.2	55				
TLD5DCH0830S09	●	8.3	56				
TLD5DCH0840S09	●	8.4					
TLD5DCH0850S09	●	8.5	57				
TLD5DCH0860S09	●	8.6	58				
TLD5DCH0870S09	●	8.7					
TLD5DCH0880S09	●	8.8	59				
TLD5DCH0890S09	●	8.9	60				
TLD5DCH0900S09	●	9					
TLD5DCH0910S10	●	9.1	61	110	9		
TLD5DCH0920S10	●	9.2	62				
TLD5DCH0930S10	●	9.3					
TLD5DCH0940S10	●	9.4	63				
TLD5DCH0950S10	●	9.5	64			120	10

FLAT DRILL **TLD5D Type**

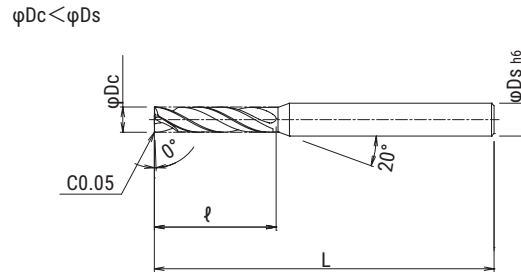
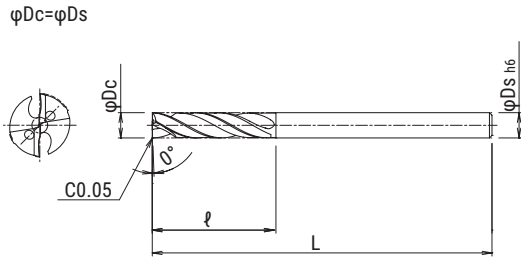

Cat.No	Stock	Dimension(mm)					
		φDc	ℓ	L	φDs		
TLD5DCH0960S10	●	9.6	64	120	10		
TLD5DCH0970S10	●	9.7	65				
TLD5DCH0980S10	●	9.8	66				
TLD5DCH0990S10	●	9.9					
TLD5DCH1000S10	●	10	67				
TLD5DCH1010S11	●	10.1	68	130	11		
TLD5DCH1020S11	●	10.2					
TLD5DCH1030S11	●	10.3	69				
TLD5DCH1040S11	●	10.4					
TLD5DCH1050S11	●	10.5	70				
TLD5DCH1060S11	●	10.6					
TLD5DCH1070S11	●	10.7	71				
TLD5DCH1080S11	●	10.8					
TLD5DCH1090S11	●	10.9	72				
TLD5DCH1100S11	●	11					
TLD5DCH1100S11	●	11	73	145	12		
TLD5DCH1110S12	●	11.1					
TLD5DCH1120S12	●	11.2	74				
TLD5DCH1130S12	●	11.3					
TLD5DCH1140S12	●	11.4	75				
TLD5DCH1150S12	●	11.5					
TLD5DCH1160S12	●	11.6	76				
TLD5DCH1170S12	●	11.7					
TLD5DCH1180S12	●	11.8	77				
TLD5DCH1190S12	●	11.9					
TLD5DCH1200S12	●	12	78				
TLD5DCH1250S13	●	12.5					
TLD5DCH1300S13	●	13	79			155	13
TLD5DCH1350S14	●	13.5					
TLD5DCH1400S14	●	14	80				
TLD5DCH1400S14	●	14					

Drill dia.	Tolerance
Dc ≤ 3	0
	-0.01
3 < Dc ≤ 6	0
	-0.012
6 < Dc ≤ 10	0
	-0.015
10 < Dc ≤ 18	0
	-0.018

FLAT DRILL**TLD3D Type**

■ Recommended cutting conditions

Material	Structural steel (SS400) below180HB		Carbon steel (S50C) below280HB		Alloy steel (SCM440) 280~350HB	
Vc (m/min)	50~100		50~100		50~80	
f (mm/rev)	0.06~0.24		0.06~0.24		0.06~0.24	
Dc (mm)	n (min ⁻¹)	Vf (mm/min)	n (min ⁻¹)	Vf (mm/min)	n (min ⁻¹)	Vf (mm/min)
3	8,500	510	8,500	510	6,375	380
4	6,375	510	6,375	510	4,775	380
5	5,100	510	5,100	510	3,825	380
6	4,250	510	4,250	510	3,175	380
7	3,650	510	3,650	510	2,725	380
8	3,175	510	3,175	510	2,375	380
9	2,825	510	2,825	510	2,125	380
10	2,550	510	2,550	510	1,900	380
11	2,325	465	2,325	465	1,725	345
12	2,125	425	2,125	425	1,600	320
13	1,950	390	1,950	390	1,475	295
14	1,825	365	1,825	365	1,375	275

Material	Mold steel (NAK80) 38~43HRC		Hardened steel (SKD61) below 50HRC		Titanium alloy (Ti-6Al-4V) 30~42HRC	
Vc (m/min)	20~50		20~50		20~50	
f (mm/rev)	0.06~0.20		0.08~0.20		0.06~0.20	
Dc (mm)	n (min ⁻¹)	Vf (mm/min)	n (min ⁻¹)	Vf (mm/min)	n (min ⁻¹)	Vf (mm/min)
3	3,175	320	3,700	300	3,175	320
4	2,375	240	2,790	260	2,375	240
5	1,900	200	2,230	200	1,900	200
6	1,600	170	1,860	160	1,600	170
7	1,375	150	1,590	150	1,375	150
8	1,200	140	1,390	140	1,200	140
9	1,050	120	1,340	140	1,050	120
10	950	110	1,110	130	950	110
11	875	110	1,010	120	875	110
12	800	100	930	120	800	100
13	725	90	860	120	725	90
14	675	90	800	120	675	90

Note

1. These cutting conditions are for drilling flat surface. For inclined angle under 30°, Apply 40-80% (Vf) from standard cutting conditions. For inclined surface over 30° or more, Apply 20-50%(Vf) from standard cutting conditions.
2. Use water-soluble coolant. In case of external coolant, use step feed.
3. Drilling over 3xDc is not recommended.
4. Side milling is not possible.
5. In case of long chips, adjust above conditions by increasing Feed speed (Vf) or using step feed for breaking chips.

FLAT DRILL**TLD3D Type****Recommended cutting conditions**

Material	Stainless steel (SUS304) belwo 280HB		Nodular cast iron (FC250) below 350MPa		Ductile cast iron (FCD400) below450MPa	
Vc (m/min)	25~50		50~100		50~100	
f (mm/rev)	0.06~0.20		0.06~0.24		0.06~0.24	
Dc (mm)	n (min ⁻¹)	Vf (mm/min)	n (min ⁻¹)	Vf (mm/min)	n (min ⁻¹)	Vf (mm/min)
3	3,175	320	8,500	510	8,500	510
4	2,375	240	6,375	510	6,375	510
5	1,900	200	5,100	510	5,100	510
6	1,600	170	4,250	510	4,250	510
7	1,375	150	3,650	510	3,650	510
8	1,200	140	3,175	510	3,175	510
9	1,050	120	2,825	510	2,825	510
10	950	110	2,550	510	2,550	510
11	875	110	2,325	465	2,325	465
12	800	100	2,125	425	2,125	425
13	725	90	1,950	390	1,950	390
14	675	90	1,825	365	1,825	365

Material	Aluminium alloy					
Vc (m/min)	120~200					
f (mm/rev)	0.05~0.15					
Dc (mm)	n (min ⁻¹)	Vf (mm/min)				
3	16,980	1,698				
4	12,730	1,273				
5	10,190	1,019				
6	8,490	849				
7	7,280	728				
8	6,370	637				
9	5,660	566				
10	5,090	509				
11	4,630	463				
12	4,240	424				
13	3,920	392				
14	3,640	364				

- Note
1. These cutting conditions are for drilling flat surface. For inclined angle under 30°, Apply 40-80% (Vf) from standard cutting conditions. For inclined surface over 30° or more, Apply 20-50% (Vf) from standard cutting conditions.
 2. Use water-soluble coolant. In case of external coolant, use step feed.
 3. Drilling over 3xDc is not recommended.
 4. Side milling is not possible.
 5. In case of long chips, adjust above conditions by increasing Feed speed (Vf) or using step feed for breaking chips.

FLAT DRILL**TLD5D Type**

■ Recommended cutting conditions

Material	Structural steel (SS400) below180HB		Carbon steel (S50C) below280HB		Alloy steel (SCM440) 280~350HB	
Vc (m/min)	50~100		50~100		50~80	
f (mm/rev)	0.06~0.24		0.06~0.24		0.06~0.24	
Dc (mm)	n (min ⁻¹)	Vf (mm/min)	n (min ⁻¹)	Vf (mm/min)	n (min ⁻¹)	Vf (mm/min)
3	8,500	510	8,500	510	6,375	380
4	6,375	510	6,375	510	4,775	380
5	5,100	510	5,100	510	3,825	380
6	4,250	510	4,250	510	3,175	380
7	3,650	510	3,650	510	2,725	380
8	3,175	510	3,175	510	2,375	380
9	2,825	510	2,825	510	2,125	380
10	2,550	510	2,550	510	1,900	380
11	2,325	465	2,325	465	1,725	345
12	2,125	425	2,125	425	1,600	320
13	1,950	390	1,950	390	1,475	295
14	1,825	365	1,825	365	1,375	275

Material	Mold steel (NAK80) 38~43HRC		Hardened steel (SKD61) below 50HRC		Titanium alloy (Ti-6Al-4V) 30~42HRC	
Vc (m/min)	20~50		30~50		20~50	
f (mm/rev)	0.06~0.20		0.08~0.20		0.06~0.20	
Dc (mm)	n (min ⁻¹)	Vf (mm/min)	n (min ⁻¹)	Vf (mm/min)	n (min ⁻¹)	Vf (mm/min)
3	3,175	320	4,240	340	3,175	320
4	2,375	240	3,180	260	2,375	240
5	1,900	200	2,550	200	1,900	200
6	1,600	170	2,120	190	1,600	170
7	1,375	150	1,820	190	1,375	150
8	1,200	140	1,590	180	1,200	140
9	1,050	120	1,420	180	1,050	120
10	950	110	1,270	170	950	110
11	875	110	1,160	170	875	110
12	800	100	1,060	160	800	100
13	725	90	980	150	725	90
14	675	90	910	150	675	90

Note

1. These cutting conditions are applied only on the condition that guide-hole drilled (0.5~1.0D depth).
2. Use water-soluble coolant. In case of external coolant, use step feed.
3. Drilling over 5xDc is not recommended.
4. Side milling is not possible.
5. In case of long chips, adjust above conditions by increasing Feed speed (Vf) or using step feed for breaking chips.

FLAT DRILL**TLD5D Type****Recommended cutting conditions**

Material	Stainless steel (SUS304) belwo 280HB		Nodular cast iron (FC250) below 350MPa		Ductile cast iron (FCD400) below450MPa	
Vc (m/min)	25~50		50~100		50~100	
f (mm/rev)	0.06~0.20		0.06~0.24		0.06~0.24	
Dc (mm)	n (min ⁻¹)	Vf (mm/min)	n (min ⁻¹)	Vf (mm/min)	n (min ⁻¹)	Vf (mm/min)
3	3,175	320	8,500	510	8,500	510
4	2,375	240	6,375	510	6,375	510
5	1,900	200	5,100	510	5,100	510
6	1,600	170	4,250	510	4,250	510
7	1,375	150	3,650	510	3,650	510
8	1,200	140	3,175	510	3,175	510
9	1,050	120	2,825	510	2,825	510
10	950	110	2,550	510	2,550	510
11	875	110	2,325	465	2,325	465
12	800	100	2,125	425	2,125	425
13	725	90	1,950	390	1,950	390
14	675	90	1,825	365	1,825	365

Material	Aluminium alloy					
Vc (m/min)	120~200					
f (mm/rev)	0.05~0.15					
Dc (mm)	n (min ⁻¹)	Vf (mm/min)				
3	16,980	1,698				
4	12,730	1,273				
5	10,190	1,019				
6	8,490	849				
7	7,280	728				
8	6,370	637				
9	5,660	566				
10	5,090	509				
11	4,630	463				
12	4,240	424				
13	3,920	392				
14	3,640	364				

Note

1. These cutting conditions are applied only on the condition that guide-hole drilled (0.5~1.0D depth).
2. Use water-soluble coolant. In case of external coolant, use step feed.
3. Drilling over 5xDc is not recommended.
4. Side milling is not possible.
5. In case of long chips, adjust above conditions by increasing Feed speed (Vf) or using step feed for breaking chips.

INDEXABLE FLAT DRILL **TLZD Type**



- 180° Flat face
- Able to drill without pilot hole, even on sloped surfaces & cross holes



■ **Features**

- 1 Easy tool management**
- 2 Able to drill without pilot hole, even on sloped surfaces and cross holes.**
- 3 Long tool life by adopting new grade JC7550 and improved coolant distribution system.**
- 4 The most suitable for burr-less processing.**

■ **Applications**

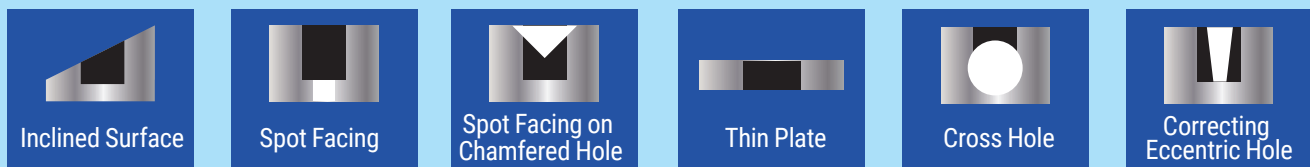

INDEXABLE FLAT DRILL

TLZD Type

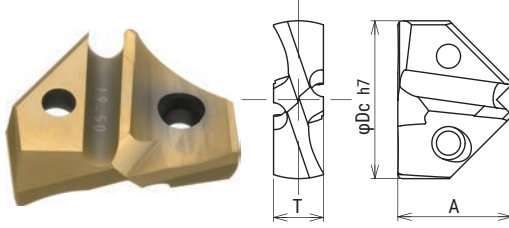

● Depth of hole: 1.5×Dc



Dia. (mm)	Insert				Holder										Parts	
	Cat.No.	PVD coating	Dimensions (mm)		Dia. Range		SS Type (1.5D)					Screw	Wrench			
			A	T			Cat.No.	Stock	ℓ	ℓ2	ℓs			L	φDs	
φDc	JC7550															
14	TLZ1400	●														
14.1	TLZ1410	●														
14.2	TLZ1420	●														
14.3	TLZ1430	●														
14.4	TLZ1440	●														
14.5	TLZ1450	●														
14.6	TLZ1460	●														
14.7	TLZ1470	●														
14.8	TLZ1480	●														
14.9	TLZ1490	●														
15	TLZ1500	●														
15.1	TLZ1510	●														
15.2	TLZ1520	●														
15.3	TLZ1530	●														
15.4	TLZ1540	●														
15.5	TLZ1550	●														
15.6	TLZ1560	●														
15.7	TLZ1570	●														
15.8	TLZ1580	●														
15.9	TLZ1590	●														
16	TLZ1600	●														
16.1	TLZ1610	●														
16.2	TLZ1620	●														
16.3	TLZ1630	●														
16.4	TLZ1640	●														
16.5	TLZ1650	●														
16.6	TLZ1660	●														
16.7	TLZ1670	●														
16.8	TLZ1680	●														
16.9	TLZ1690	●														
17	TLZ1700	●														
17.1	TLZ1710	●														
17.2	TLZ1720	●														
17.3	TLZ1730	●														
17.4	TLZ1740	●														
17.5	TLZ1750	●														
17.6	TLZ1760	●														
17.7	TLZ1770	●														
17.8	TLZ1780	●														
17.9	TLZ1790	●														
18	TLZ1800	●														
18.1	TLZ1810	●														
18.2	TLZ1820	●														
18.3	TLZ1830	●														
18.4	TLZ1840	●														
18.5	TLZ1850	●														

INDEXABLE FLAT DRILL **TLZD Type**

$\varphi D_c \leq \varphi 30$

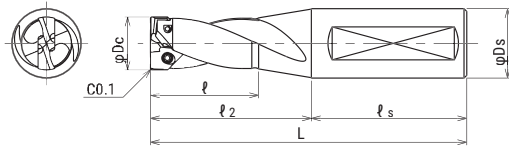

$\varphi D_c > \varphi 30$

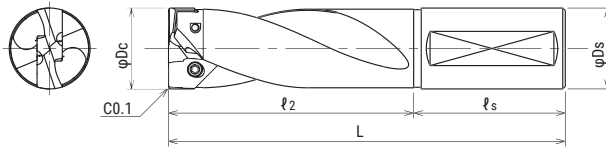

Dia. (mm)	Insert				Holder										Parts	
	Cat.No.	PVD coating	Dimensions (mm)		Dia. Range		SS Type (1.5D)					Screw	Wrench			
			A	T			Cat.No.	Stock	ℓ	ℓ_2	ℓ_s			L	φD_s	
φD_c	JC7550															
18.6	TLZ1860	●	13.6	6.0	18.6	19.5	TLZD1900S25-SS	●	39	69	56	114	25	TSW-2567H	A-08	
18.7	TLZ1870	●														
18.8	TLZ1880	●														
18.9	TLZ1890	●														
19	TLZ1900	●														
19.1	TLZ1910	●														
19.2	TLZ1920	●														
19.3	TLZ1930	●														
19.4	TLZ1940	●														
19.5	TLZ1950	●														
19.6	TLZ1960	●	14.6	6.5	19.6	20.5	TLZD2000S25-SS	●	41	61	56	117	25	TSW-2567H	A-08	
19.7	TLZ1970	●														
19.8	TLZ1980	●														
19.9	TLZ1990	●														
20	TLZ2000	●														
20.5	TLZ2050	●														
21	TLZ2100	●	15.2	6.7	21.0	21.5	TLZD2100S25-SS	●	43	64	56	120	25	TSW-2567H	A-08	
21.5	TLZ2150	●														
22	TLZ2200	●	15.9	7.5	22.0	22.5	TLZD2200S25-SS	●	45	67	56	123	25	DSW-307H	A-10	
22.5	TLZ2250	●														
23	TLZ2300	●	16.7	7.5	23.0	23.5	TLZD2300S25-SS	●	47	70	56	126	25	DSW-307H	A-10	
23.5	TLZ2350	●														
24	TLZ2400	●	17.4	8.0	24.0	24.5	TLZD2400S32-SS	●	49	73	60	133	32	DSW-307H	A-10	
24.5	TLZ2450	●														
25	TLZ2500	●	18.3	8.0	25.0	25.5	TLZD2500S32-SS	●	51	76	60	136	32	DSW-309H	A-10	
25.5	TLZ2550	●														
26	TLZ2600	●	18.8	8.5	26.0	26.5	TLZD2600S32-SS	●	53	79	60	139	32	DSW-309H	A-10	
26.5	TLZ2650	●														
27	TLZ2700	●	19.5	8.5	27.0	27.5	TLZD2700S32-SS	●	55	82	60	142	32	DSW-309H	A-10	
27.5	TLZ2750	●														
28	TLZ2800	●	20.3	9.0	28.0	28.5	TLZD2800S32-SS	●	57	85	60	145	32	TSW-3510H	A-15	
28.5	TLZ2850	●														
29	TLZ2900	●	21.1	9.0	29.0	29.5	TLZD2900S32-SS	●	59	88	60	148	32	TSW-3510H	A-15	
29.5	TLZ2950	●														
30	TLZ3000	●	21.5	9.5	30.0	30.5	TLZD3000S32-SS	●	61	91	60	151	32	TSW-3510H	A-15	
30.5	TLZ3050	●														
31	TLZ3100	●	22.3	10.0	31.0	31.5	TLZD3100S32-SS	●	-	94	60	154	32	TSW-3512H	A-15	
31.5	TLZ3150	●														
32	TLZ3200	●	23.1	10.0	32.0	32.5	TLZD3200S32-SS	●	-	97	60	157	32	TSW-3512H	A-15	

INDEXABLE FLAT DRILL**TLZD Type**

■ Recommended cutting conditions

Material	General steel (SS400) below 180HB		Carbon steel (S50C) below 280HB		Tool steel (SKD61,SKD11) below 255HB	
	Vc (m/min)	f (mm/rev)	n (min ⁻¹)	Vf (mm/min)	n (min ⁻¹)	Vf (mm/min)
	50~100 (φ14~φ32)	0.06~0.20 (φ14~φ16) 0.07~0.21 (φ17~φ20) 0.08~0.22 (φ21~φ25) 0.09~0.23 (φ26~φ29) 0.10~0.24 (φ30~φ32)	50~100 (φ14~φ32)	0.06~0.20 (φ14~φ16) 0.07~0.21 (φ17~φ20) 0.08~0.22 (φ21~φ25) 0.09~0.23 (φ26~φ29) 0.10~0.24 (φ30~φ32)	30~70 (φ14~φ32)	0.06~0.20 (φ14~φ16) 0.07~0.21 (φ17~φ20) 0.08~0.22 (φ21~φ25) 0.09~0.23 (φ26~φ29) 0.10~0.24 (φ30~φ32)
Dc (mm)	n (min ⁻¹)	Vf (mm/min)	n (min ⁻¹)	Vf (mm/min)	n (min ⁻¹)	Vf (mm/min)
14	1,590	190	1,590	190	1,140	140
15	1,490	180	1,490	180	1,060	130
16	1,390	170	1,390	170	990	120
17	1,310	170	1,310	170	940	120
18	1,240	160	1,240	160	880	110
19	1,170	150	1,170	150	840	110
20	1,110	150	1,110	150	800	110
21	1,060	150	1,060	150	760	110
22	1,010	140	1,010	140	720	100
23	970	140	970	140	690	100
24	930	130	930	130	660	90
25	890	130	890	130	640	90
26	860	130	860	130	610	90
27	830	120	830	120	590	90
28	800	120	800	120	570	90
29	770	120	770	120	550	80
30	740	120	740	120	530	80
31	720	120	720	120	510	80
32	700	110	700	110	500	80

Note

1. These cutting conditions are for drilling flat surface. For inclined angle under 30°, Apply 40-80% (Vf) from standard cutting conditions.
For inclined surface over 30° or more, Apply 20-50% (Vf) from standard cutting conditions.
2. These cutting conditions are for drilling with water soluble coolant. In case of dry cutting, use air to remove the chips.
3. Drilling over 1.5xDc is not recommended.
4. Side milling is not possible.
5. In case of long chips, adjust above conditions by increasing Feed speed (Vf) or using step feed for breaking chips.

INDEXABLE FLAT DRILL**TLZD Type**

■ Recommended cutting conditions

Material	Alloy steel (SCM440) 280~350HB		Mold steel (NAK80) 40HRC		Nodular/Ductile Cast iron (FC/FCD)	
Vc (m/min)	30~70 (φ14~φ32)		20~40 (φ14~φ32)		50~100 (φ14~φ32)	
f (mm/rev)	0.06~0.20 (φ14~φ16) 0.07~0.21 (φ17~φ20) 0.08~0.22 (φ21~φ25) 0.09~0.23 (φ26~φ29) 0.10~0.24 (φ30~φ32)		0.04~0.10 (φ14~φ16) 0.04~0.11 (φ17~φ18) 0.05~0.11 (φ19~φ20) 0.05~0.12 (φ21~φ25) 0.05~0.13 (φ26~φ27) 0.06~0.13 (φ28~φ29) 0.06~0.14 (φ30~φ32)		0.06~0.20 (φ14~φ16) 0.07~0.21 (φ17~φ20) 0.08~0.22 (φ21~φ25) 0.09~0.23 (φ26~φ29) 0.10~0.24 (φ30~φ32)	
Dc (mm)	n (min ⁻¹)	Vf (mm/min)	n (min ⁻¹)	Vf (mm/min)	n (min ⁻¹)	Vf (mm/min)
14	1,140	140	680	40	1,590	190
15	1,060	130	640	40	1,490	180
16	990	120	600	40	1,390	170
17	940	120	560	40	1,310	170
18	880	110	530	40	1,240	160
19	840	110	500	40	1,170	150
20	800	110	480	40	1,110	150
21	760	110	450	40	1,060	150
22	720	100	430	30	1,010	140
23	690	100	420	30	970	140
24	660	90	400	30	930	130
25	640	90	380	30	890	130
26	610	90	370	30	860	130
27	590	90	350	30	830	120
28	570	90	340	30	800	120
29	550	80	330	30	770	120
30	530	80	320	30	740	120
31	510	80	310	30	720	120
32	500	80	300	30	700	110

Note

1. These cutting conditions are for drilling flat surface. For inclined angle under 30°, Apply 40-80% (Vf) from standard cutting conditions.
For inclined surface over 30° or more, Apply 20-50% (Vf) from standard cutting conditions.
2. These cutting conditions are for drilling with water soluble coolant. In case of dry cutting, use air to remove the chips.
3. Drilling over 1.5xDc is not recommended.
4. Side milling is not possible.
5. In case of long chips, adjust above conditions by increasing Feed speed (Vf) or using step feed for breaking chips.

INDEXABLE FLAT DRILL**TLZD Type**

■ Recommended cutting conditions

Material	Stainless steel (SUS304)		Aluminium alloy (AC/ADC)			
Vc (m/min)	80~140 (φ14~φ32)		50~150 (φ14~φ32)			
f (mm/rev)	0.02~0.06 (φ14~φ18) 0.03~0.07 (φ19~φ25) 0.04~0.08 (φ26~φ31) 0.05~0.09 (φ32)		0.06~0.20 (φ14~φ16) 0.07~0.21 (φ17~φ20) 0.08~0.22 (φ21~φ25) 0.09~0.23 (φ26~φ29) 0.10~0.24 (φ30~φ32)			
Dc (mm)	n (min ⁻¹)	Vf (mm/min)	n (min ⁻¹)	Vf (mm/min)		
14	2,270	90	2,270	270		
15	2,120	90	2,120	250		
16	1,990	80	1,990	240		
17	1,870	80	1,870	240		
18	1,770	80	1,770	240		
19	1,840	80	1,840	240		
20	1,750	80	1,750	230		
21	1,670	80	1,670	230		
22	1,590	80	1,590	220		
23	1,520	80	1,520	210		
24	1,460	80	1,460	200		
25	1,400	80	1,400	200		
26	1,350	80	1,350	200		
27	1,300	80	1,300	200		
28	1,360	80	1,360	200		
29	1,320	80	1,320	200		
30	1,270	80	1,270	200		
31	1,230	80	1,230	200		
32	1,190	80	1,190	190		

Note

1. These cutting conditions are for drilling flat surface. For inclined angle under 30°, Apply 40-80% (Vf) from standard cutting conditions.
For inclined surface over 30° or more, Apply 20-50% (Vf) from standard cutting conditions.
2. These cutting conditions are for drilling with water soluble coolant. In case of dry cutting, use air to remove the chips.
3. Drilling over 1.5xDc is not recommended.
4. Side milling is not possible.
5. In case of long chips, adjust above conditions by increasing Feed speed (Vf) or using step feed for breaking chips.
If cutting stainless steel, not recommended to increase Feed speed for breaking chips.
Increase cutting speed (Vc) and reduce Feed speed (Vf) so that bellows-shaped chips can occur.

INDEXABLE FLAT DRILL **TLZD Type**

PROCEDURE FOR MOUNTING INSERT

1. Removing used insert

Make sure to remove any chips or dust off the tip before removing the used insert. Remove used insert and clean pocket using a brush or air blowing before loading new insert.

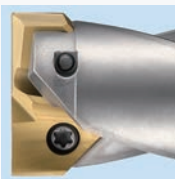

2. Loading new insert

Place new insert in pocket, lightly tighten two screws while pressing the top of the insert (see photo). After confirming there is no gap between the drill and insert, tighten the insert screw, starting with the same screw you first lightly tightened, to the recommended torque while still pressing the top of the insert.



"MOLY"
(Sold separately)

⚠ Note:

Clamp screw needs to be changed out after replacing the insert approximately 10 times or if you see any issues with the screws.



Clamp screw

■ HOLE BOTTOM SHAPE

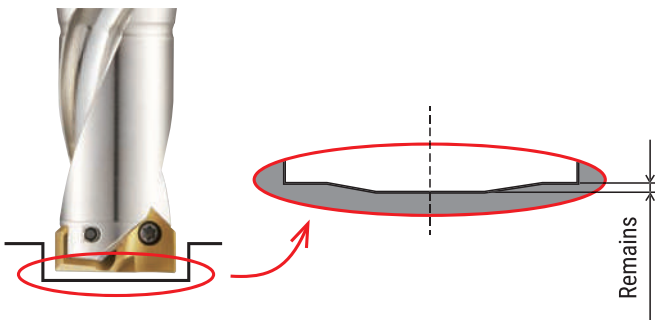

Tool dia. (mm)	Remains (mm)
φ14~φ20.5	0.04~0.06
φ21~φ26.5	0.05~0.07
φ27~φ32.0	0.06~0.08

INDEXABLE FLAT DRILL **TLZD Type**

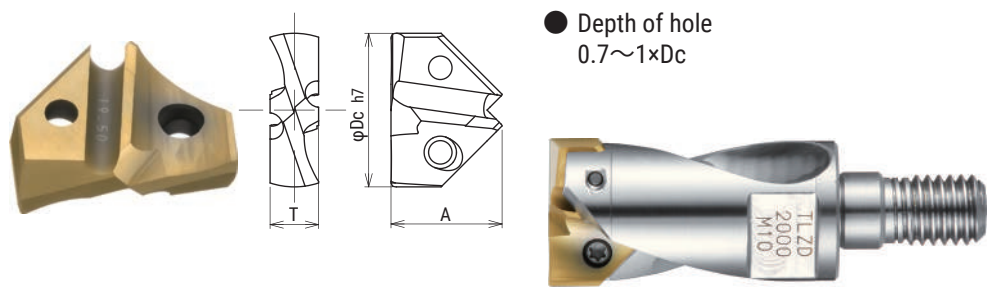
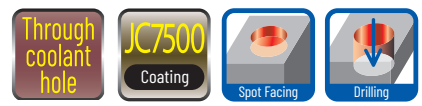

● Depth of hole
0.7~1xDc

Dia. (mm)	Insert			Holder								Parts		MSN carbide shank		
	Cat.No.	PVD coating	Dimensions (mm)	Dia. Range				TLZD Type (0.7~1D)					Screw		Wrench	
								Cat.No.	Stock	Dimensions (mm)						
φDc	JC7550	A	T	φ	ℓ ₂	ℓ _s	L			φDs						
14	TLZ1400	●	10.6	4.5	14.0	14.5	TLZD1400-M6	●	27.5	13.1	M6	7	10	DSW-2045H	A-07	MSN-M6-***S16C
14.1	TLZ1410	●														
14.2	TLZ1420	●														
14.3	TLZ1430	●														
14.4	TLZ1440	●														
14.5	TLZ1450	●														
14.6	TLZ1460	●	11.3	4.8	14.6	15.5	TLZD1500-M8	●	29.5	14	M8	8	12	DSW-2045H	A-07	MSN-M8-***S14C
14.7	TLZ1470	●														
14.8	TLZ1480	●														
14.9	TLZ1490	●														
15	TLZ1500	●														
15.1	TLZ1510	●														
15.2	TLZ1520	●														
15.3	TLZ1530	●														
15.4	TLZ1540	●														
15.5	TLZ1550	●														
15.6	TLZ1560	●	12.1	5.0	15.6	16.5	TLZD1600-M8	●	29.5	15	M8	8	12	TSW-2556H	A-08	MSN-M8-***S15C
15.7	TLZ1570	●														
15.8	TLZ1580	●														
15.9	TLZ1590	●														
16	TLZ1600	●														
16.1	TLZ1610	●														
16.2	TLZ1620	●														
16.3	TLZ1630	●														
16.4	TLZ1640	●														
16.5	TLZ1650	●														
16.6	TLZ1660	●	12.6	17.5	16.6	17.5	TLZD1700-M8	●	30.5	16	M8	8	12	TSW-2556H	A-08	MSN-M8-***S16C
16.7	TLZ1670	●														
16.8	TLZ1680	●														
16.9	TLZ1690	●														
17	TLZ1700	●														
17.1	TLZ1710	●														
17.2	TLZ1720	●														
17.3	TLZ1730	●														
17.4	TLZ1740	●														
17.5	TLZ1750	●														
17.6	TLZ1760	●	13.2	5.8	17.6	18.5	TLZD1800-M8	●	30.5	17	M8	8	12	TSW-2556H	A-08	MSN-M8-***S16C
17.7	TLZ1770	●														
17.8	TLZ1780	●														
17.9	TLZ1790	●														
18	TLZ1800	●														
18.1	TLZ1810	●														
18.2	TLZ1820	●														
18.3	TLZ1830	●														
18.4	TLZ1840	●														
18.5	TLZ1850	●														

INDEXABLE FLAT DRILL

TLZD Type

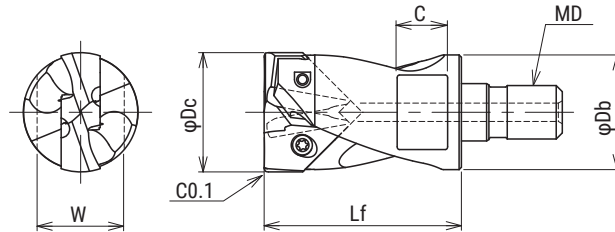

Dia. (mm)	Insert				Holder								Parts		MSN carbide shank	
	Cat.No.	PVD coating	Dimensions (mm)		Dia. Range		TLZD Type (0.7~1D)					Screw	Wrench			
			JC7550	A			T	Cat.No.	Stock	Dimensions (mm)						
φDc							ℓ	ℓ ₂	ℓ _s	L	φDs					
18.6	TLZ1860	●	13.6	6.0	18.5	19.5	TLZD1400-M6	●	27.5	13.1	M6	7	10	DSW-2045H	A-07	MSN-M6-**-S16C
18.7	TLZ1870	●														
18.8	TLZ1880	●														
18.9	TLZ1890	●														
19	TLZ1900	●														
19.1	TLZ1910	●														
19.2	TLZ1920	●														
19.3	TLZ1930	●														
19.4	TLZ1940	●														
19.5	TLZ1950	●														
19.6	TLZ1960	●	14.6	6.5	19.5	20.5	TLZD2000-M10	●	8.5	19	M10	9	14	TSW-2567H	A-08	MSN-M10-**-S20C
19.7	TLZ1970	●														
19.8	TLZ1980	●														
19.9	TLZ1990	●														
20	TLZ2000	●														
20.5	TLZ2050	●														
21	TLZ2100	●	15.2	6.7	20.5	21.5	TLZD2100-M10	●	38.5	20	M10	9	14	TSW-2567H	A-08	MSN-M10-**-S-S20C
21.5	TLZ2150	●														
22	TLZ2200	●	15.9	7.5	21.5	22.5	TLZD2200-M10	●	38.5	21	M10	9	14	DSW-307H	A-10	MSN-M10-**-S-S20C
22.5	TLZ2250	●														
23	TLZ2300	●	16.7	7.5	22.5	23.5	TLZD2300-M10	●	43	22	M10	9	14	DSW-307H	A-10	MSN-M10-**-S-S20C
23.5	TLZ2350	●														
24	TLZ2400	●	17.4	8.0	23.5	24.5	TLZD2400-M12	●	43	23	M12	11	19	DSW-307H	A-10	MSN-M12-**-S-S23C
24.5	TLZ2450	●														
25	TLZ2500	●	18.3	8.0	24.5	25.5	TLZD2500-M12	●	43	24	M12	11	19	DSW-309H	A-10	MSN-M12-**-S-S25C
25.5	TLZ2550	●														
26	TLZ2600	●	18.8	8.5	25.5	26.5	TLZD2600-M12	●	43	25	M12	11	19	DSW-309H	A-10	MSN-M12-**-S-S25C
26.5	TLZ2650	●														
27	TLZ2700	●	19.5	8.5	26.5	27.5	TLZD2700-M12	●	43	26	M12	11	19	DSW-309H	A-10	MSN-M12-**-S-S25C
27.5	TLZ2750	●														
28	TLZ2800	●	20.3	9.0	27.5	28.5	TLZD2800-M12	●	51	27	M12	11	19	TSW-3510H	A-15	MSN-M12-**-S-S25C
28.5	TLZ2850	●														
29	TLZ2900	●	21.1	9.0	28.5	29.5	TLZD2900-M16	●	51	28	M16	12	22	TSW-3510H	A-15	MSN-M16-**-S-S28C
29.5	TLZ2950	●														
30	TLZ3000	●	21.5	9.5	29.5	30.5	TLZD3000-M16	●	51	29	M16	12	22	TSW-3510H	A-15	MSN-M16-**-S-S32C
30.5	TLZ3050	●														
31	TLZ3100	●	22.3	10.0	30.5	31.5	TLZD3100-M16	●	51	30	M16	12	22	TSW-3512H	A-15	MSN-M16-**-S-S32C
31.5	TLZ3150	●														
32	TLZ3200	●	23.1	10.0	31.5	32.5	TLZD3200-M16	●	38.5	31	M16	14	26	TSW-3512H	A-15	MSN-M16-**-S-S32C

Screw	Torque (N·m)
DSW-2045H	0.9
TSW-2556H	1.2
TSW-2567H	1.2
DSW-307H	2.1
DSW-309H	2.1
TSW-3510H	3.0
TSW-3512H	3.0

INDEXABLE FLAT DRILL

TLZD Type

■ Recommended cutting conditions

Material	General steel (SS400) below 180HB				Carbon steel (S50C) below 280HB				Tool steel (SKD61,SKD11) below 255HB		Alloy steel (SCM440) 280~350HB			
	70 (φ14~φ32)				70 (φ14~φ32)				70 (φ14~φ32)					
Vc (m/min)	0.04~0.06 (φ14) 0.04~0.08 (φ15~φ18) 0.04~0.09 (φ19~φ23) 0.06~0.12 (φ24~φ28) 0.06~0.14 (φ29~φ32)				0.04~0.06 (φ14) 0.04~0.08 (φ15~φ18) 0.04~0.09 (φ19~φ23) 0.06~0.12 (φ24~φ28) 0.06~0.14 (φ29~φ32)				0.03~0.05 (φ14) 0.03~0.06 (φ15~φ18) 0.04~0.07 (φ19~φ23) 0.05~0.09 (φ24~φ28) 0.06~0.11 (φ29~φ32)					
f (mm/rev)	Dc (mm)		ℓ (mm)	H (mm)	n (min ⁻¹)	Vf (mm/min)	ℓ (mm)	H (mm)	n (min ⁻¹)	Vf (mm/min)	ℓ (mm)	H (mm)	n (min ⁻¹)	Vf (mm/min)
14	40	10	1,590	100	40	10	1,590	100	40	10	1,590	80		
	60	10	1,590	60	60	10	1,590	60	60	10	1,590	50		
	80	10	1,590	60	80	10	1,590	60	80	10	1,590	50		
	-	-	-	-	-	-	-	-	-	-	-	-	-	-
15	50	11	1,490	110	50	11	1,490	110	50	11	1,490	90		
	70	11	1,490	90	70	11	1,490	90	70	11	1,490	70		
	110	11	1,490	60	110	11	1,490	60	110	11	1,490	45		
16	50	11	1,390	105	50	11	1,390	105	50	11	1,390	85		
	70	11	1,390	85	70	11	1,390	85	70	11	1,390	65		
	110	11	1,390	55	110	11	1,390	55	110	11	1,390	40		
17	50	12	1,310	100	50	12	1,310	100	50	12	1,310	80		
	70	12	1,310	80	70	12	1,310	80	70	12	1,310	60		
	110	12	1,310	50	110	12	1,310	50	110	12	1,310	40		
18	50	13	1,240	100	50	13	1,240	100	50	13	1,240	75		
	70	13	1,240	75	70	13	1,240	75	70	13	1,240	55		
	110	13	1,240	50	110	13	1,240	50	110	13	1,240	35		
19	60	19	1,170	105	60	19	1,170	105	60	19	1,170	85		
	80	19	1,170	95	80	19	1,170	95	80	19	1,170	75		
	110	19	1,170	70	110	19	1,170	70	110	19	1,170	65		
	130	19	1,170	50	130	19	1,170	50	130	19	1,170	45		
	-	-	-	-	-	-	-	-	-	-	-	-	-	-
20	60	20	1,110	100	60	20	1,110	100	60	20	1,110	80		
	80	20	1,110	90	80	20	1,110	90	80	20	1,110	70		
	110	20	1,110	70	110	20	1,110	70	110	20	1,110	60		
	130	20	1,110	50	130	20	1,110	50	130	20	1,110	40		
	-	-	-	-	-	-	-	-	-	-	-	-	-	-
21	60	21	1,060	95	60	21	1,060	95	60	21	1,060	75		
	80	21	1,060	85	80	21	1,060	85	80	21	1,060	65		
	110	21	1,060	65	110	21	1,060	65	110	21	1,060	55		
	130	21	1,060	45	130	21	1,060	45	130	21	1,060	35		
	-	-	-	-	-	-	-	-	-	-	-	-	-	-

INDEXABLE FLAT DRILL**TLZD Type**

■ Recommended cutting conditions

Material	General steel (SS400) below 180HB				Carbon steel (S50C) below 280HB				Tool steel (SKD61,SKD11) below 255HB		Alloy steel (SCM440) 280~350HB	
	70 (φ14~φ32)				70 (φ14~φ32)				70 (φ14~φ32)			
Vc (m/min)	0.04~0.06 (φ14) 0.04~0.08 (φ15~φ18) 0.04~0.09 (φ19~φ23) 0.06~0.12 (φ24~φ28) 0.06~0.14 (φ29~φ32)				0.04~0.06 (φ14) 0.04~0.08 (φ15~φ18) 0.04~0.09 (φ19~φ23) 0.06~0.12 (φ24~φ28) 0.06~0.14 (φ29~φ32)				0.03~0.05 (φ14) 0.03~0.06 (φ15~φ18) 0.04~0.07 (φ19~φ23) 0.05~0.09 (φ24~φ28) 0.06~0.11 (φ29~φ32)			
f (mm/rev)												
Dc (mm)	ℓ (mm)	H (mm)	n (min ⁻¹)	Vf (mm/min)	ℓ (mm)	H (mm)	n (min ⁻¹)	Vf (mm/min)	ℓ (mm)	H (mm)	n (min ⁻¹)	Vf (mm/min)
22	60	22	1,010	90	60	22	1,010	90	60	22	1,010	70
	80	22	1,010	80	80	22	1,010	80	80	22	1,010	60
	110	22	1,010	60	110	22	1,010	60	110	22	1,010	55
	130	22	1,010	40	130	22	1,010	40	130	22	1,010	35
	-	-	-	-	-	-	-	-	-	-	-	-
23	60	23	970	85	60	23	970	85	60	23	970	70
	80	23	970	75	80	23	970	75	80	23	970	60
	110	23	970	55	110	23	970	55	110	23	970	50
	130	23	970	35	130	23	970	35	130	23	970	35
	-	-	-	-	-	-	-	-	-	-	-	-
24	70	24	930	110	70	24	930	110	70	24	930	85
	100	24	930	85	100	24	930	85	100	24	930	75
	150	24	930	65	150	24	930	65	150	24	930	55
	180	24	930	55	180	24	930	55	180	24	930	45
	-	-	-	-	-	-	-	-	-	-	-	-
25	70	25	890	100	70	25	890	100	70	25	890	80
	100	25	890	80	100	25	890	80	100	25	890	70
	150	25	890	60	150	25	890	60	150	25	890	50
	180	25	890	50	180	25	890	50	180	25	890	40
	-	-	-	-	-	-	-	-	-	-	-	-
26	70	26	890	100	70	26	890	100	70	26	860	80
	100	26	890	80	100	26	890	80	100	26	860	70
	150	26	890	60	150	26	890	60	150	26	860	50
	180	26	890	50	180	26	890	50	180	26	860	40
	-	-	-	-	-	-	-	-	-	-	-	-
27	70	27	830	95	70	27	830	95	70	27	830	75
	100	27	830	75	100	27	830	75	100	27	830	65
	150	27	830	55	150	27	830	55	150	27	830	45
	180	27	830	45	180	27	830	45	180	27	830	35
	-	-	-	-	-	-	-	-	-	-	-	-

INDEXABLE FLAT DRILL

TLZD Type

■ Recommended cutting conditions

Material	General steel (SS400) below 180HB				Carbon steel (S50C) below 280HB				Tool steel (SKD61,SKD11) below 255HB		Alloy steel (SCM440) 280~350HB			
	70 (φ14~φ32)				70 (φ14~φ32)				70 (φ14~φ32)					
Vc (m/min)	0.04~0.06 (φ14) 0.04~0.08 (φ15~φ18) 0.04~0.09 (φ19~φ23) 0.06~0.12 (φ24~φ28) 0.06~0.14 (φ29~φ32)				0.04~0.06 (φ14) 0.04~0.08 (φ15~φ18) 0.04~0.09 (φ19~φ23) 0.06~0.12 (φ24~φ28) 0.06~0.14 (φ29~φ32)				0.03~0.05 (φ14) 0.03~0.06 (φ15~φ18) 0.04~0.07 (φ19~φ23) 0.05~0.09 (φ24~φ28) 0.06~0.11 (φ29~φ32)					
f (mm/rev)	Dc (mm)		ℓ (mm)	H (mm)	n (min ⁻¹)	Vf (mm/min)	ℓ (mm)	H (mm)	n (min ⁻¹)	Vf (mm/min)	ℓ (mm)	H (mm)	n (min ⁻¹)	Vf (mm/min)
28	70	28	800	95	70	28	800	95	70	28	800	75		
	100	28	800	75	100	28	800	75	100	28	800	65		
	150	28	800	55	150	28	800	55	150	28	800	45		
	180	28	800	45	180	28	800	45	180	28	800	35		
	-	-	-	-	-	-	-	-	-	-	-	-	-	-
29	80	29	770	105	80	29	770	105	80	29	770	85		
	110	29	770	85	110	29	770	85	110	29	770	75		
	130	29	770	75	130	29	770	75	130	29	770	65		
	150	29	770	70	150	29	770	70	150	29	770	55		
	180	29	770	45	180	29	770	45	180	29	770	45		
30	80	30	740	105	80	30	740	105	80	30	740	85		
	110	30	740	85	110	30	740	85	110	30	740	75		
	130	30	740	75	130	30	740	75	130	30	740	60		
	150	30	740	70	150	30	740	70	150	30	740	50		
	180	30	740	45	180	30	740	45	180	30	740	40		
31	80	31	720	100	80	31	720	100	80	31	720	80		
	110	31	720	80	110	31	720	80	110	31	720	70		
	130	31	720	70	130	31	720	70	130	31	720	60		
	150	31	720	65	150	31	720	65	150	31	720	50		
	180	31	720	40	180	31	720	40	180	31	720	40		
32	80	32	700	100	80	32	700	100	80	32	700	80		
	110	32	700	80	110	32	700	80	110	32	700	70		
	130	32	700	70	130	32	700	70	130	32	700	60		
	150	32	700	60	150	32	700	60	150	32	700	50		
	180	32	700	40	180	32	700	40	180	32	700	40		
	-	-	-	-	-	-	-	-	-	-	-	-	-	-

INDEXABLE FLAT DRILL**TLZD Type**

■ Recommended cutting conditions

Material	Mold steel (NAK80) 40HRC				Nodular/Ductile Cast iron (FC/FCD)				Stainless steel (SUS304)			
	40 (φ14~φ32)				100 (φ14~φ32)				100 (φ14~φ32)			
V _c (m/min)												
f (mm/rev)	0.02~0.06 (φ14) 0.03~0.07 (φ15~φ18) 0.03~0.08 (φ19~φ23) 0.04~0.10 (φ24~φ28) 0.05~0.13 (φ29~φ32)				0.02~0.07 (φ14) 0.04~0.09 (φ15~φ18) 0.02~0.10 (φ19~φ23) 0.02~0.12 (φ24~φ28) 0.02~0.13 (φ29~φ32)				0.02~0.04 (φ14~φ23) 0.03~0.04 (φ24~φ32)			
D _c (mm)	ℓ (mm)	H (mm)	n (min ⁻¹)	V _f (mm/min)	ℓ (mm)	H (mm)	n (min ⁻¹)	V _f (mm/min)	ℓ (mm)	H (mm)	n (min ⁻¹)	V _f (mm/min)
14	40	10	910	50	40	10	2,270	160	40	10	2,270	80
	60	10	910	20	60	10	2,270	100	60	10	2,270	50
	80	10	910	20	80	10	2,270	100	80	10	2,270	50
	-	-	-	-	110	10	2,270	50	-	-	-	-
15	50	11	850	55	50	11	2,120	180	50	11	2,120	80
	70	11	850	45	70	11	2,120	150	70	11	2,120	65
	110	11	850	25	110	11	2,120	90	110	11	2,120	45
16	50	11	800	50	50	11	1,990	170	50	11	1,990	70
	70	11	800	40	70	11	1,990	140	70	11	1,990	60
	110	11	800	20	110	11	1,990	85	110	11	1,990	40
17	50	12	750	50	50	12	1,870	160	50	12	1,870	70
	70	12	750	40	70	12	1,870	130	70	12	1,870	60
	110	12	750	20	110	12	1,870	80	110	12	1,870	40
18	50	13	710	45	50	13	1,770	150	50	13	1,770	65
	70	13	710	35	70	13	1,770	120	70	13	1,770	55
	110	13	710	20	110	13	1,770	75	110	13	1,770	35
19	60	19	670	50	60	19	1,670	155	60	19	1,670	60
	80	19	670	40	80	19	1,670	135	80	19	1,670	50
	110	19	670	30	110	19	1,670	105	110	19	1,670	40
	130	19	670	20	130	19	1,670	75	130	19	1,670	30
	-	-	-	-	180	19	1,670	30	-	-	-	-
20	60	20	640	50	60	20	1,590	150	60	20	1,590	60
	80	20	640	40	80	20	1,590	130	80	20	1,590	50
	110	20	640	30	110	20	1,590	100	110	20	1,590	40
	130	20	640	20	130	20	1,590	70	130	20	1,590	30
	-	-	-	-	180	20	1,590	30	-	-	-	-
21	60	21	610	50	60	21	1,510	140	60	21	1,510	55
	80	21	610	40	80	21	1,510	120	80	21	1,510	45
	110	21	610	30	110	21	1,510	95	110	21	1,510	35
	130	21	610	20	130	21	1,510	65	130	21	1,510	25
	-	-	-	-	180	21	1,510	25	-	-	-	-

INDEXABLE FLAT DRILL**TLZD Type**

■ Recommended cutting conditions

Material	Mold steel (NAK80) 40HRC				Nodular/Ductile Cast iron (FC/FCD)				Stainless steel (SUS304)			
	40 (φ14~φ32)				100 (φ14~φ32)				100 (φ14~φ32)			
V _c (m/min)	40 (φ14~φ32)				100 (φ14~φ32)				100 (φ14~φ32)			
f (mm/rev)	0.02~0.06 (φ14) 0.03~0.07 (φ15~φ18) 0.03~0.08 (φ19~φ23) 0.04~0.10 (φ24~φ28) 0.05~0.13 (φ29~φ32)				0.02~0.07 (φ14) 0.04~0.09 (φ15~φ18) 0.02~0.10 (φ19~φ23) 0.02~0.12 (φ24~φ28) 0.02~0.13 (φ29~φ32)				0.02~0.04 (φ14~φ23) 0.03~0.04 (φ24~φ32)			
D _c (mm)	ℓ (mm)	H (mm)	n (min ⁻¹)	V _f (mm/min)	ℓ (mm)	H (mm)	n (min ⁻¹)	V _f (mm/min)	ℓ (mm)	H (mm)	n (min ⁻¹)	V _f (mm/min)
22	60	22	580	45	60	22	1,450	135	60	22	1,450	55
	80	22	580	35	80	22	1,450	115	80	22	1,450	45
	110	22	580	25	110	22	1,450	90	110	22	1,450	35
	130	22	580	15	130	22	1,450	65	130	22	1,450	25
	-	-	-	-	180	22	1,450	25	-	-	-	-
23	60	23	550	45	60	23	1,380	130	60	23	1,380	50
	80	23	550	35	80	23	1,380	110	80	23	1,380	40
	110	23	550	25	110	23	1,380	85	110	23	1,380	35
	130	23	550	15	130	23	1,380	60	130	23	1,380	25
	-	-	-	-	180	23	1,380	25	-	-	-	-
24	70	24	530	55	70	24	1,330	150	70	24	1,330	55
	100	24	530	45	100	24	1,330	120	100	24	1,330	45
	150	24	530	30	150	24	1,330	85	150	24	1,330	35
	180	24	530	20	180	24	1,330	75	180	24	1,330	35
	-	-	-	-	200	24	1,330	35	-	-	-	-
25	70	25	510	50	70	25	1,270	145	70	25	1,270	50
	100	25	510	40	100	25	1,270	115	100	25	1,270	40
	150	25	510	30	150	25	1,270	80	150	25	1,270	30
	180	25	510	20	180	25	1,270	70	180	25	1,270	30
	-	-	-	-	200	25	1,270	30	-	-	-	-
26	70	26	490	50	70	26	1,220	140	70	26	1,220	50
	100	26	490	40	100	26	1,220	110	100	26	1,220	40
	150	26	490	30	150	26	1,220	80	150	26	1,220	30
	180	26	490	20	180	26	1,220	70	180	26	1,220	30
	-	-	-	-	200	26	1,220	30	-	-	-	-
27	70	27	470	50	70	27	1,180	135	70	27	1,180	50
	100	27	470	40	100	27	1,180	105	100	27	1,180	40
	150	27	470	30	150	27	1,180	75	150	27	1,180	30
	180	27	470	20	180	27	1,180	65	180	27	1,180	30
	-	-	-	-	200	27	1,180	30	-	-	-	-

INDEXABLE FLAT DRILL**TLZD Type**

■ Recommended cutting conditions

Material	Mold steel (NAK80) 40HRC				Nodular/Ductile Cast iron (FC/FCD)				Stainless steel (SUS304)			
	40 (φ14~φ32)				100 (φ14~φ32)				100 (φ14~φ32)			
Vc (m/min)												
f (mm/rev)	0.02~0.06 (φ14) 0.03~0.07 (φ15~φ18) 0.03~0.08 (φ19~φ23) 0.04~0.10 (φ24~φ28) 0.05~0.13 (φ29~φ32)				0.02~0.07 (φ14) 0.04~0.09 (φ15~φ18) 0.02~0.10 (φ19~φ23) 0.02~0.12 (φ24~φ28) 0.02~0.13 (φ29~φ32)				0.02~0.04 (φ14~φ23) 0.03~0.04 (φ24~φ32)			
Dc (mm)	ℓ (mm)	H (mm)	n (min ⁻¹)	Vf (mm/min)	ℓ (mm)	H (mm)	n (min ⁻¹)	Vf (mm/min)	ℓ (mm)	H (mm)	n (min ⁻¹)	Vf (mm/min)
28	70	28	450	45	70	28	1,140	130	70	28	1,140	45
	100	28	450	35	100	28	1,140	100	100	28	1,140	35
	150	28	450	30	150	28	1,140	75	150	28	1,140	25
	180	28	450	20	180	28	1,140	65	180	28	1,140	25
	-	-	-	-	200	28	1,140	30	-	-	-	-
29	80	29	440	55	80	29	1,100	140	80	29	1,100	45
	110	29	440	45	110	29	1,100	110	110	29	1,100	45
	130	29	440	40	130	29	1,100	100	130	29	1,100	40
	150	29	440	30	150	29	1,100	90	150	29	1,100	30
	180	29	440	20	180	29	1,100	55	180	29	1,100	30
-	-	-	-	210	29	1,100	20	-	-	-	-	
30	80	30	420	50	80	30	1,060	135	80	30	1,060	40
	110	30	420	40	110	30	1,060	105	110	30	1,060	40
	130	30	420	35	130	30	1,060	95	130	30	1,060	35
	150	30	420	30	150	30	1,060	85	150	30	1,060	30
	180	30	420	20	180	30	1,060	50	180	30	1,060	30
-	-	-	-	210	30	1,060	20	-	-	-	-	
31	80	31	410	50	80	31	1,030	130	80	31	1,030	40
	110	31	410	40	110	31	1,030	100	110	31	1,030	40
	130	31	410	35	130	31	1,030	90	130	31	1,030	35
	150	31	410	30	150	31	1,030	80	150	31	1,030	30
	180	31	410	20	180	31	1,030	50	180	31	1,030	30
-	-	-	-	210	31	1,030	20	-	-	-	-	
32	80	32	400	50	80	32	1,000	130	80	32	1,000	40
	110	32	400	40	110	32	1,000	100	110	32	1,000	40
	130	32	400	35	130	32	1,000	90	130	32	1,000	35
	150	32	400	30	150	32	1,000	80	150	32	1,000	30
	180	32	400	20	180	32	1,000	50	180	32	1,000	30
-	-	-	-	210	32	1,000	20	-	-	-	-	

INDEXABLE FLAT DRILL

TLZD Type

■ Recommended cutting conditions

Material	Aluminium alloy (AC/ADC)				
Vc (m/min)	100 (φ14~φ32)				
f (mm/rev)	0.02~0.07 (φ14) 0.04~0.09 (φ15~φ18) 0.02~0.10 (φ19~φ23) 0.02~0.12 (φ24~φ28) 0.02~0.13 (φ29~φ32)				
Dc (mm)	ℓ (mm)	H (mm)	n (min ⁻¹)	Vf (mm/min)	
14	40	10	2,270	160	
	60	10	2,270	100	
	80	10	2,270	100	
	110	10	2,270	50	
15	50	11	2,120	180	
	70	11	2,120	150	
	110	11	2,120	90	
16	50	11	1,990	170	
	70	11	1,990	140	
	110	11	1,990	85	
17	50	12	1,870	160	
	70	12	1,870	130	
	110	12	1,870	80	
18	50	13	1,770	150	
	70	13	1,770	120	
	110	13	1,770	75	
19	60	19	1,670	155	
	80	19	1,670	135	
	110	19	1,670	105	
	130	19	1,670	75	
	180	19	1,670	30	
20	60	20	1,590	150	
	80	20	1,590	130	
	110	20	1,590	100	
	130	20	1,590	70	
	180	20	1,590	30	
21	60	21	1,510	140	
	80	21	1,510	120	
	110	21	1,510	95	
	130	21	1,510	65	
	180	21	1,510	25	

Material	Aluminium alloy (AC/ADC)				
Vc (m/min)	100 (φ14~φ32)				
f (mm/rev)	0.02~0.07 (φ14) 0.04~0.09 (φ15~φ18) 0.02~0.10 (φ19~φ23) 0.02~0.12 (φ24~φ28) 0.02~0.13 (φ29~φ32)				
Dc (mm)	ℓ (mm)	H (mm)	n (min ⁻¹)	Vf (mm/min)	
22	60	22	1,450	135	
	80	22	1,450	115	
	110	22	1,450	90	
	130	22	1,450	65	
	180	22	1,450	25	
23	60	23	1,380	130	
	80	23	1,380	110	
	110	23	1,380	85	
	130	23	1,380	60	
24	180	23	1,380	25	
	70	24	1,330	150	
	100	24	1,330	120	
	150	24	1,330	85	
25	180	24	1,330	75	
	200	24	1,330	35	
	70	25	1,270	145	
	100	25	1,270	115	
26	150	25	1,270	80	
	180	25	1,270	70	
	200	25	1,270	30	
	70	26	1,220	140	
	100	26	1,220	110	
27	150	26	1,220	80	
	180	26	1,220	70	
	200	26	1,220	30	
	70	27	1,180	135	
	100	27	1,180	105	
27	150	27	1,180	75	
	180	27	1,180	65	
	200	27	1,180	30	

INDEXABLE FLAT DRILL**TLZD Type****Recommended cutting conditions**

Material	Aluminium alloy (AC/ADC)				
Vc (m/min)	100 (φ14~φ32)				
f (mm/rev)	0.02~0.07 (φ14) 0.04~0.09 (φ15~φ18) 0.02~0.10 (φ19~φ23) 0.02~0.12 (φ24~φ28) 0.02~0.13 (φ29~φ32)				
Dc (mm)	ℓ (mm)	H (mm)	n (min ⁻¹)	Vf (mm/min)	
28	70	28	1,140	130	
	100	28	1,140	100	
	150	28	1,140	75	
	180	28	1,140	65	
	200	28	1,140	30	
29	80	29	1,100	140	
	110	29	1,100	110	
	130	29	1,100	100	
	150	29	1,100	90	
	180	29	1,100	55	
30	210	29	1,100	20	
	80	30	1,060	135	
	110	30	1,060	105	
	130	30	1,060	95	
	150	30	1,060	85	
31	180	30	1,060	50	
	210	30	1,060	20	
	80	31	1,030	130	
	110	31	1,030	100	
	130	31	1,030	90	
32	150	31	1,030	80	
	180	31	1,030	50	
	210	31	1,030	20	
	80	32	1,000	130	
	110	32	1,000	100	
32	130	32	1,000	90	
	150	32	1,000	80	
	180	32	1,000	50	
	210	32	1,000	20	

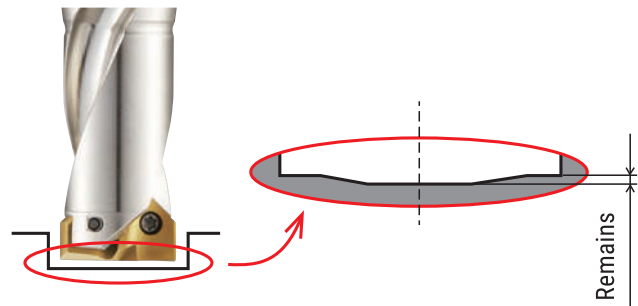
HOLE BOTTOM SHAPE

Tool dia. (mm)	Remains (mm)
φ14~φ20.5	0.04~0.06
φ21~φ26.5	0.05~0.07
φ27~φ32.0	0.06~0.08

Note

1. These cutting conditions are for drilling flat surface. For inclined angle under 30°, Apply 40-80% (Vf) from standard cutting conditions.

For inclined surface over 30° or more, Apply 20-50% (Vf) from standard cutting conditions.

2. These cutting conditions are for drilling with water soluble coolant. In case of dry cutting, use air to remove the chips.

3. Drilling over 1.0xDc is not recommended.

4. Side milling is not possible.

5. In case of long chips, adjust above conditions by increasing Feed speed (Vf) or using step feed for breaking chips.

If cutting stainless steel, not recommended to increase Feed speed for breaking chips.

Increase cutting speed (Vc) and reduce Feed speed (Vf) so that bellows-shaped chips can occur.

INDEXABLE DRILL **TEZD Type**

EASY ASSEMBLY AND HIGH PERFORMANCE



ECO-FRIENDLY

Unique low cutting geometry reduces power consumption.

ECONOMICAL

Save tool cost compared with using solid carbide drill

HIGH CUTTING PERFORMANCE

Distinctive cooling system ensures coolant is supplied to cutting edge.



■ LINE UP

Holder	Depth of hole	Diameter
TEZD-MS Type	3xDc	φ13.5~φ32.5
TEZD-ML Type	5xDc	
TEZD-XL Type	8xDc	

INDEXABLE DRILL**TEZD Type****PROCEDURE FOR MOUNTING INSERT****1. Removing used insert**

Make sure to remove any chips or dust off the tip before removing the used insert. Remove used insert and clean pocket using a brush or air blowing before loading new insert.

**2. Loading new insert**

Place new insert in pocket, lightly tighten two screws while pressing the top of the insert (see photo). After confirming there is no gap between the drill and insert, tighten the insert screw, starting with the same screw you first lightly tightened, to the recommended torque while still pressing the top of the insert.



"MOLY"
(Sold separately)

**Note:**

Clamp screw need to be changed out after replacing the insert approximately 10 times or if you see any issues with the screws.



Clamp screw

IF USING LATHE MACHINE

1. Check run out of insert O.D. within 0.03mm (off set of center 0.015mm) and flute O.D. of shank side within approx. 0.03mm.
2. Due to large thrust of cutting forces, make sure drill is fully seated in holder.
3. Reduce the cutting speed and feed rate by 20% from standard cutting conditions.

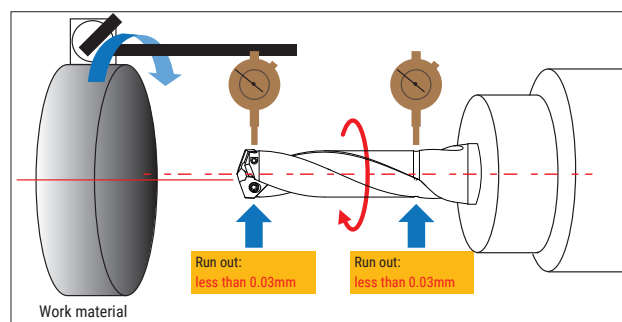

INDEXABLE DRILL

TEZD Type

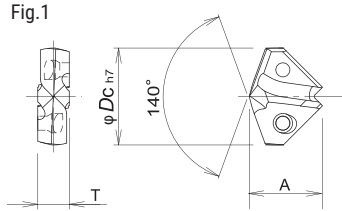

● MS type (3D) / ML type (5D)

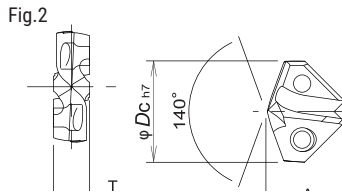

● XL type (8D)



Dia. Range	Cat.No.	Stock	L/D	Dimensions (mm)							Dia. (mm)	for General (Fig.1) JC8050		for High-temp alloy (Fig.2) JC7515		Dimensions (mm)		Parts	
				ℓ	ℓ ₂	ℓ _s	L	φDs	φDf	MT		Stock	Stock	A	T	Screw	Wrench		
																		Cat.No.	Cat.No.
13.5 ~ 14.5	TEZD1400S16-MS	●	3	51	65	48	113	16	-	-	13.5	TEZ1350	●	TEZ1350S	●	11.4	4.5	DSW-2045H	A-07
											13.6	TEZ1360	●	TEZ1360S	●				
											13.7	TEZ1370	●	TEZ1370S	●				
	13.8	TEZ1380	●	TEZ1380S	●														
	13.9	TEZ1390	●	TEZ1390S	●														
	14.0	TEZ1400	●	TEZ1400S	●														
	14.1	TEZ1410	●	TEZ1410S	●														
	14.2	TEZ1420	●	TEZ1420S	●														
	14.3	TEZ1430	●	TEZ1430S	●														
	14.4	TEZ1440	●	TEZ1440S	●														
14.6 ~ 15.5	TEZD1500S20-MS	●	3	54	69	50	119	20	-	-	14.5	TEZ1450	●	TEZ1450S	●	11.5	4.8	DSW-2045H	A-07
											14.6	TEZ1460	●	TEZ1460S	●				
											14.7	TEZ1470	●	TEZ1470S	●				
	14.8	TEZ1480	●	TEZ1480S	●														
	14.9	TEZ1490	●	TEZ1490S	●														
	15.0	TEZ1500	●	TEZ1500S	●														
	15.1	TEZ1510	●	TEZ1510S	●														
	15.2	TEZ1520	●	TEZ1520S	●														
	15.3	TEZ1530	●	TEZ1530S	●														
	15.4	TEZ1540	●	TEZ1540S	●														
15.6 ~ 16.5	TEZD1500S20-MS	●	3	58	74	50	124	20	-	-	15.5	TEZ1550	●	TEZ1550S	●	12.4	5.0	TSW-2556H	A-08
											15.6	TEZ1560	●	TEZ1560S	●				
											15.7	TEZ1570	●	TEZ1570S	●				
	15.8	TEZ1580	●	TEZ1580S	●														
	15.9	TEZ1590	●	TEZ1590S	●														
	16.0	TEZ1600	●	TEZ1600S	●														
	16.1	TEZ1610	●	TEZ1610S	●														
	16.2	TEZ1620	●	TEZ1620S	●														
	16.3	TEZ1630	●	TEZ1630S	●														
	16.4	TEZ1640	●	TEZ1640S	●														
16.6 ~ 17.5	TEZD1700S20-MS	●	3	61	78	50	128	20	-	-	16.5	TEZ1650	●	TEZ1650S	●	13.2	5.5	TSW-2556H	A-08
											16.6	TEZ1660	●	TEZ1660S	●				
											16.7	TEZ1670	●	TEZ1670S	●				
	16.8	TEZ1680	●	TEZ1680S	●														
	16.9	TEZ1690	●	TEZ1690S	●														
	17.0	TEZ1700	●	TEZ1700S	●														
	17.1	TEZ1710	●	TEZ1710S	●														
	17.2	TEZ1720	●	TEZ1720S	●														
	17.3	TEZ1730	●	TEZ1730S	●														
	17.4	TEZ1740	●	TEZ1740S	●														
17.6 ~ 18.5	TEZD1800S20-MS	●	3	65	83	50	133	20	-	-	17.5	TEZ1750	●	TEZ1750S	●	13.5	5.8	TSW-2556H	A-08
											17.6	TEZ1760	●	TEZ1760S	●				
											17.7	TEZ1770	●	TEZ1770S	●				
	17.8	TEZ1780	●	TEZ1780S	●														
	17.9	TEZ1790	●	TEZ1790S	●														
	18.0	TEZ1800	●	TEZ1800S	●														
	18.1	TEZ1810	●	TEZ1810S	●														
	18.2	TEZ1820	●	TEZ1820S	●														
	18.3	TEZ1830	●	TEZ1830S	●														
	18.4	TEZ1840	●	TEZ1840S	●														
18.5	TEZ1850	●	TEZ1850S	●															

Note:
One insert per case

INDEXABLE DRILL TEZD Type



- MS type (3D) / ML type (5D)
- XL type (8D)

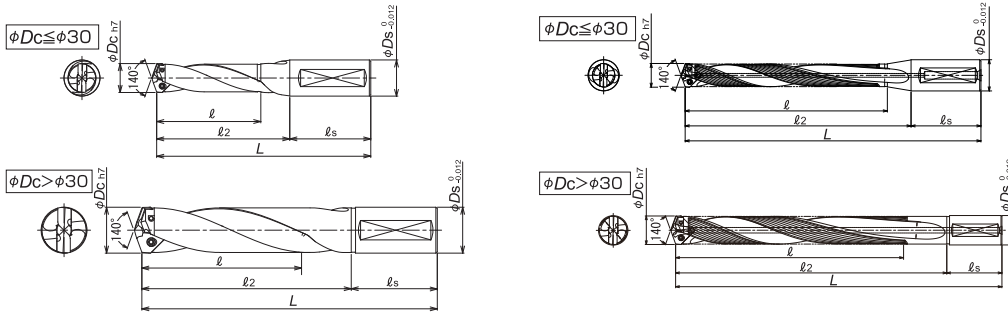

Screw	Torque (N·m)
DSW-2045H	0.9
TSW-2556H	1.2
TSW-2567H	1.2
DSW-307H	2.1
DSW-309H	2.1
TSW-3510H	3.0
TSW-3512H	3.0

Dia. Range	Cat.No.	Stock	L/D	Dimensions (mm)							Dia. (mm)	for General (Fig.1) JC8050		for High-temp alloy (Fig.2) JC7515		Dimensions (mm)		Parts	
				ℓ	ℓ ₂	ℓ _s	L	φDs	φDf	MT		Stock	Stock	Stock	A	T	Screw	Wrench	
															Cat.No.	Cat.No.			
18.6 ~ 19.5	TEZD1900S25-MS	●	3	68	87	56	143	25	-	-	18.6	TEZ1860	●	TEZ1860S	●	14.2	6.0	TSW-2567H	A-08
	TEZD1900S25-ML	●	5	107	130	56	186	25	-	-	18.7	TEZ1870	●	TEZ1870S	●				
	TEZD1900S25-XL	●	8	162	181	56	237	25	-	-	18.8	TEZ1880	●	TEZ1880S	●				
											18.9	TEZ1890	●	TEZ1890S	●				
											19.0	TEZ1900	●	TEZ1900S	●				
											19.1	TEZ1910	●	TEZ1910S	●				
											19.2	TEZ1920	●	TEZ1920S	●				
											19.3	TEZ1930	●	TEZ1930S	●				
											19.4	TEZ1940	●	TEZ1940S	●				
											19.5	TEZ1950	●	TEZ1950S	●				
19.6 ~ 20.5	TEZD2000S25-MS	●	3	72	92	56	148	25	-	-	19.6	TEZ1960	●	TEZ1960S	●	15.1	6.5	TSW-2567H	A-08
	TEZD2000S25-ML	●	5	113	137	56	193	25	-	-	19.7	TEZ1970	●	TEZ1970S	●				
	TEZD2000S25-XL	●	8	170	190	56	246	25	-	-	19.8	TEZ1980	●	TEZ1980S	●				
											19.9	TEZ1990	●	TEZ1990S	●				
											20.0	TEZ2000	●	TEZ2000S	●				
											20.1	TEZ2010	●	-	●				
											20.2	TEZ2020	●	-	●				
											20.3	TEZ2030	●	-	●				
											20.4	TEZ2040	●	-	●				
											20.5	TEZ2050	●	-	●				
20.6 ~ 21.5	TEZD2100S25-MS	●	3	75	96	56	152	25	-	-	20.6	TEZ2060	●	-	●	15.7	6.7	TSW-2567H	A-08
	TEZD2100S25-ML	●	5	118	143	56	199	25	-	-	20.7	TEZ2070	●	-	●				
	TEZD2100S25-XL	●	8	179	200	56	256	25	-	-	20.8	TEZ2080	●	-	●				
											20.9	TEZ2090	●	-	●				
											21.0	TEZ2100	●	-	●				
											21.1	TEZ2110	●	-	●				
											21.2	TEZ2120	●	-	●				
											21.3	TEZ2130	●	-	●				
											21.4	TEZ2140	●	-	●				
											21.5	TEZ2150	●	-	●				
21.6 ~ 22.5	TEZD2200S25-MS	●	3	79	101	56	157	25	-	-	21.6	TEZ2160	●	-	●	16.6	7.5	DSW-307H	A-10
	TEZD2200S25-ML	●	5	124	150	56	206	25	-	-	21.7	TEZ2170	●	-	●				
	TEZD2200S25-XL	●	8	187	209	56	265	25	-	-	21.8	TEZ2180	●	-	●				
											21.9	TEZ2190	●	-	●				
											22.0	TEZ2200	●	-	●				
											22.1	TEZ2210	●	-	●				
											22.2	TEZ2220	●	-	●				
											22.3	TEZ2230	●	-	●				
											22.4	TEZ2240	●	-	●				
											22.5	TEZ2250	●	-	●				
22.6 ~ 23.5	TEZD2300S25-MS	●	3	82	105	56	161	25	-	-	22.6	TEZ2260	●	-	●	17.4	7.5	DSW-307H	A-10
	TEZD2300S25-ML	●	5	129	157	56	213	25	-	-	22.7	TEZ2270	●	-	●				
	TEZD2300S25-XL	●	8	196	219	56	275	25	-	-	22.8	TEZ2280	●	-	●				
											22.9	TEZ2290	●	-	●				
											23.0	TEZ2300	●	-	●				
											23.1	TEZ2310	●	-	●				
											23.2	TEZ2320	●	-	●				
											23.3	TEZ2330	●	-	●				
											23.4	TEZ2340	●	-	●				
											23.5	TEZ2350	●	-	●				

Note:
One insert per case

INDEXABLE DRILL

TEZD Type

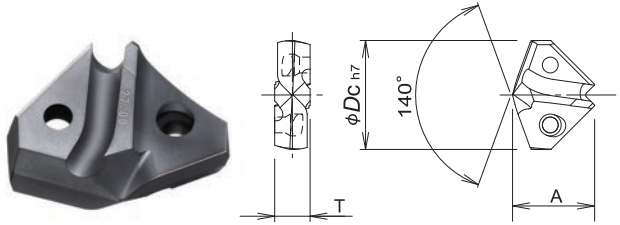

● MS type (3D) / ML type (5D)



● XL type (8D)



Dia. Range	Cat.No.	Stock	L/D	Dimensions (mm)							Dia. (mm)	for General (Fig.1) JC8050	Stock	Dimensions (mm)		Parts	
				ℓ	ℓ ₂	ℓ _s	L	φDs	φDf	MT				A	T	Screw	Wrench
23.6 ~ 24.5	TEZD2400S32-MS	●	3	86	110	60	170	32	-	-	23.6	TEZ2360	●	18.2	8.0	DSW-307H	A-10
											23.7	TEZ2370					
											23.8	TEZ2380					
											23.9	TEZ2390					
											24.0	TEZ2400					
	TEZD2400S32-ML	●	5	135	164	60	224	32	-	-	24.1	TEZ2410	●				
											24.2	TEZ2420					
											24.3	TEZ2430					
											24.4	TEZ2440					
											24.5	TEZ2450					
24.6 ~ 25.5	TEZD2500S32-MS	●	3	89	114	60	174	32	-	-	24.6	TEZ2460	●	19.1	8.0	DSW-309H	A-10
											24.7	TEZ2470					
											24.8	TEZ2480					
											24.9	TEZ2490					
											25.0	TEZ2500					
	TEZD2500S32-ML	●	5	140	170	60	230	32	-	-	25.1	TEZ2510	●				
											25.2	TEZ2520					
											25.3	TEZ2530					
											25.4	TEZ2540					
											25.5	TEZ2550					
25.6 ~ 23.5	TEZD2600S32-MS	●	3	93	119	60	179	32	-	-	25.6	TEZ2560	●	19.7	8.5	DSW-309H	A-1
											25.7	TEZ2570					
											25.8	TEZ2580					
											25.9	TEZ2590					
											26.0	TEZ2600					
	TEZD2600S32-ML	●	5	146	177	60	237	32	-	-	26.1	TEZ2610	●				
											26.2	TEZ2620					
											26.3	TEZ2630					
											26.4	TEZ2640					
											26.5	TEZ2650					
26.5 ~ 27.5	TEZD2700S32-MS	●	3	96	123	60	183	32	-	-	26.6	TEZ2660	●	20.4	8.5	TSW-3510H	A-15
											26.7	TEZ2670					
											26.8	TEZ2680					
											26.9	TEZ2690					
											27.0	TEZ2700					
	TEZD2700S32-ML	●	5	151	184	60	244	32	-	-	27.1	TEZ2710	●				
											27.2	TEZ2720					
											27.3	TEZ2730					
											27.4	TEZ2740					
											27.5	TEZ2750					
27.6 ~ 25.5	TEZD2800S32-MS	●	3	100	128	60	188	32	-	-	27.6	TEZ2760	●	21.2	9.0	TSW-3510H	A-15
											27.7	TEZ2770					
											27.8	TEZ2780					
											27.9	TEZ2790					
											28.0	TEZ2800					
	TEZD2800S32-ML	●	5	157	190	60	250	32	-	-	28.1	TEZ2810	●				
											28.2	TEZ2820					
											28.3	TEZ2830					
											28.4	TEZ2840					
											28.5	TEZ2850					
27.6 ~ 25.5	TEZD2800S32-XL	●	8	238	266	60	326	32	-	-	28.6	TEZ2860	●				
											28.7	TEZ2870					
											28.8	TEZ2880					
											28.9	TEZ2890					
											29.0	TEZ2900					

Note:
One insert per case

INDEXABLE DRILL TEZD Type



● MS type (3D) / ML type (5D)

● XL type (8D)

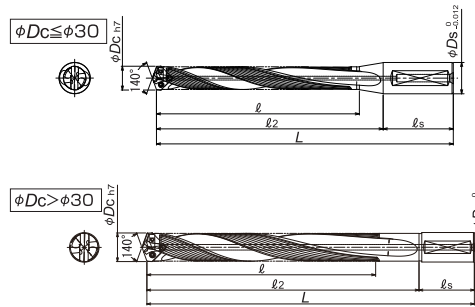
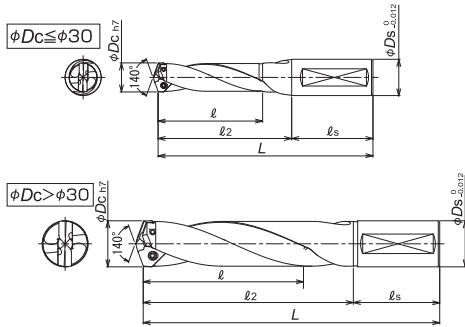

Screw	Torque (N·m)
DSW-2045H	0.9
TSW-2556H	1.2
TSW-2567H	1.2
DSW-307H	2.1
DSW-309H	2.1
TSW-3510H	3.0
TSW-3512H	3.0

Dia. Range	Cat.No.	Stock	L/D	Dimensions (mm)							Dia. (mm)	for General (Fig.1) JC8050	Stock	Dimensions (mm)		Parts		
				ℓ	ℓ_2	ℓ_s	L	ϕDs	ϕDf	MT				Cat.No.	A	T	Screw	Wrench
28.6 ~ 29.5	TEZD2900S32-MS	●	3	103	132	60	192	32	-	-	28.6	TEZ2860	●	22.1	9.0	TSW-3510H	A-15	
	TEZD2900S32-ML	●	5	162	197	60	257	32	-	-	28.7	TEZ2870						
	TEZD2900S32-MS	●	3	107	137	60	197	32	-	-	28.8	TEZ2880						
	TEZD2900S32-ML	●	5	162	197	60	257	32	-	-	28.9	TEZ2890						
	TEZD2900S32-MS	●	3	107	137	60	197	32	-	-	29.0	TEZ2900						
	TEZD2900S32-ML	●	5	162	197	60	257	32	-	-	29.1	TEZ2910						
	TEZD2900S32-MS	●	3	107	137	60	197	32	-	-	29.2	TEZ2920						
	TEZD2900S32-ML	●	5	162	197	60	257	32	-	-	29.3	TEZ2930						
	TEZD2900S32-MS	●	3	107	137	60	197	32	-	-	29.4	TEZ2940						
	TEZD2900S32-ML	●	5	162	197	60	257	32	-	-	29.5	TEZ2950						
29.6 ~ 30.5	TEZD3000S32-MS	●	3	107	137	60	197	32	-	-	29.6	TEZ2960	●	22.5	9.5	TSW-3510H	A-15	
	TEZD3000S32-ML	●	5	168	204	60	264	32	-	-	29.7	TEZ2970						
	TEZD3000S32-MS	●	3	107	137	60	197	32	-	-	29.8	TEZ2980						
	TEZD3000S32-ML	●	5	168	204	60	264	32	-	-	29.9	TEZ2990						
	TEZD3000S32-MS	●	3	110	141	60	201	32	-	-	30.0	TEZ3000						
	TEZD3000S32-ML	●	5	173	210	60	270	32	-	-	30.1	TEZ3010						
	TEZD3000S32-MS	●	3	110	141	60	201	32	-	-	30.2	TEZ3020						
	TEZD3000S32-ML	●	5	173	210	60	270	32	-	-	30.3	TEZ3030						
	TEZD3000S32-MS	●	3	110	141	60	201	32	-	-	30.4	TEZ3040						
	TEZD3000S32-ML	●	5	173	210	60	270	32	-	-	30.5	TEZ3050						
30.6 ~ 31.5	TEZD3100S32-MS	●	3	110	141	60	201	32	-	-	30.6	TEZ3060	●	23.4	10.0	TSW-3512H	A-15	
	TEZD3100S32-ML	●	5	173	210	60	270	32	-	-	30.7	TEZ3070						
	TEZD3100S32-MS	●	3	110	141	60	201	32	-	-	30.8	TEZ3080						
	TEZD3100S32-ML	●	5	173	210	60	270	32	-	-	30.9	TEZ3090						
	TEZD3100S32-MS	●	3	114	146	60	206	32	-	-	31.0	TEZ3100						
	TEZD3100S32-ML	●	5	179	217	60	277	32	-	-	31.1	TEZ3110						
	TEZD3100S32-MS	●	3	114	146	60	206	32	-	-	31.2	TEZ3120						
	TEZD3100S32-ML	●	5	179	217	60	277	32	-	-	31.3	TEZ3130						
	TEZD3100S32-MS	●	3	114	146	60	206	32	-	-	31.4	TEZ3140						
	TEZD3100S32-ML	●	5	179	217	60	277	32	-	-	31.5	TEZ3150						
31.6 ~ 32.5	TEZD3200S32-MS	●	3	114	146	60	206	32	-	-	31.6	TEZ3160	●	24.3	10.0	TSW-3512H	A-15	
	TEZD3200S32-ML	●	5	179	217	60	277	32	-	-	31.7	TEZ3170						
	TEZD3200S32-MS	●	3	114	146	60	206	32	-	-	31.8	TEZ3180						
	TEZD3200S32-ML	●	5	179	217	60	277	32	-	-	31.9	TEZ3190						
	TEZD3200S32-MS	●	3	114	146	60	206	32	-	-	32.0	TEZ3200						
	TEZD3200S32-ML	●	5	179	217	60	277	32	-	-	32.1	TEZ3210						
	TEZD3200S32-MS	●	3	114	146	60	206	32	-	-	32.2	TEZ3220						
	TEZD3200S32-ML	●	5	179	217	60	277	32	-	-	32.3	TEZ3230						
	TEZD3200S32-MS	●	3	114	146	60	206	32	-	-	32.4	TEZ3240						
	TEZD3200S32-ML	●	5	179	217	60	277	32	-	-	32.5	TEZ3250						

Note:
One insert per case



SOLID CARBIDE ENDMILLS

ONE-CUT 70 **SEH Type**

One-Cut 70
UP TO 70HRC

Feature 1

High Speed & High Efficiency Machining on High Hardened Materials.

Feature 2

High Precision Machining from Semi-finishing to Finishing.

Feature 3

Outstanding tool life with combination of newly developed DH coating & Super-micro grain carbide

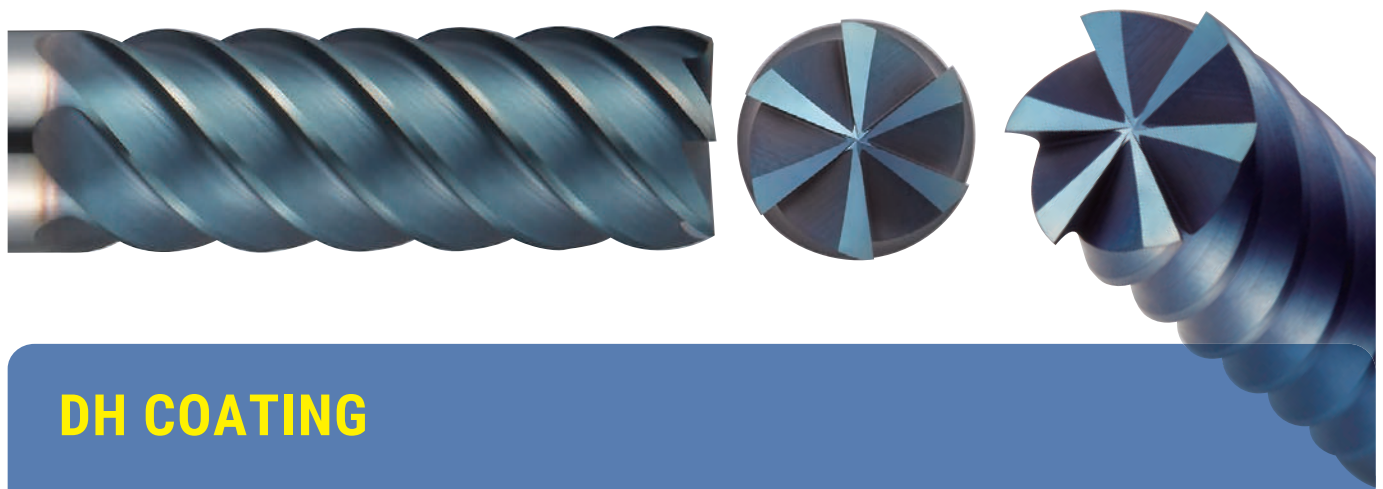

DH COATING

● Properties of DIJET PVD coating

	DH coating	DV coating	DZ coating (TiAlN)
Hardness (Hv)	3,500~3,700	3,300~3,500	2,800~2,900
Oxidation temperature (°C)	1,100~1,200	1,000~1,100	700~800
Coefficient of friction	0.5	0.65	0.6

- Greatly improved for higher hardness and heat resistance.
- Super multi layer coating that has high thermal shock resistance suppress sudden chipping.
- Achieves excellent tool life from semi-finishing to finishing.

Layer with high hardness & heat resistance
 Layer with high adhesion & fracture resistance
 Super micro-grain carbide

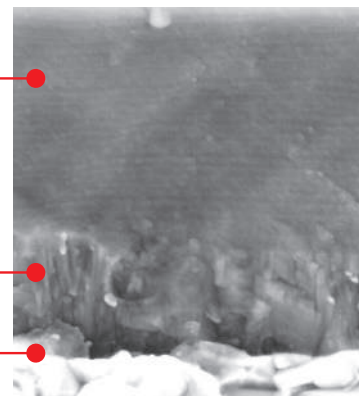

ONE-CUT 70 **SEH Type**

- For High hardened materials up to 70HRC
- Helix angle 50°



Gash land



DH
Coating



Shoulder Milling

Roughing

Semi-finishing

Finishing

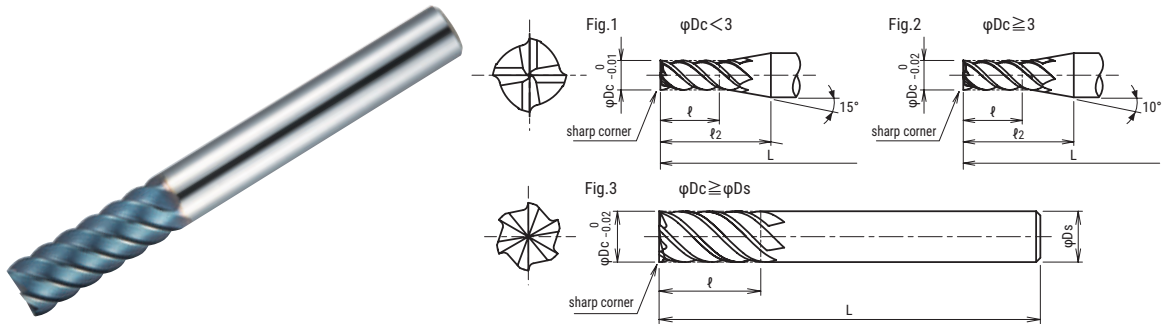

Type	Cat.No.	Stock	No. of Flutes	Dimensions (mm)					Fig.
				φDc	φ	$\varphi 2$	L	φDs	
Short	SEHS4010	●	4	1	2	12			1
	SEHS4020	●		2	4				
	SEHS4030	●		3	7				
	SEHS4040	●		4	9	16			2
	SEHS4050	●		5	12				
	SEHS6060	●		6	6	13			—
Regular	SEHH4010	●	4	1	3.5	13	60	6	1
	SEHH4015	●		1.5	5				
	SEHH4020	●		2	7				
	SEHH4025	●		2.5	8	15			2
	SEHH4030	●		3	10				
	SEHH4035	●		3.5	12	20			
	SEHH4040	●		4		19			
	SEHH4045	●		4.5		20			
	SEHH4050	●		5	15	19			3
	SEHH4055	●		5.5		18			
	SEHH6060	●		6		—			
	SEHH6065	●		6.5	20	25			75
	SEHH6070	●	7	24					
	SEHH6075	●	7.5	22					
	SEHH6080	●	8	25	—	80	10		
	SEHH6085	●	8.5		30				
	SEHH6090	●	9		29				
	SEHH6095	●	9.5	30	27	100	12		
	SEHH6100	●	10		—				
	SEHH6105	●	10.5		35				
	SEHH6110	●	11	35	34	105	16		
	SEHH6120	●	12		—				
	SEHH6130	●	13		45				
	SEHH6140	●	14	40	42	110	2		
SEHH6150	●	15	44						
SEHH6160	●	16	—						
SEHH6180	●	18	45	47	120	20			
SEHH6200	●	20		—			125		

ONE-CUT 70

SEH Type

- For High hardened materials up to 70HRC
- Helix angle 50°
- Corner radius R0.2



Gash land



DH Coating



Shoulder Milling

Roughing

Semi-finishing

Finishing

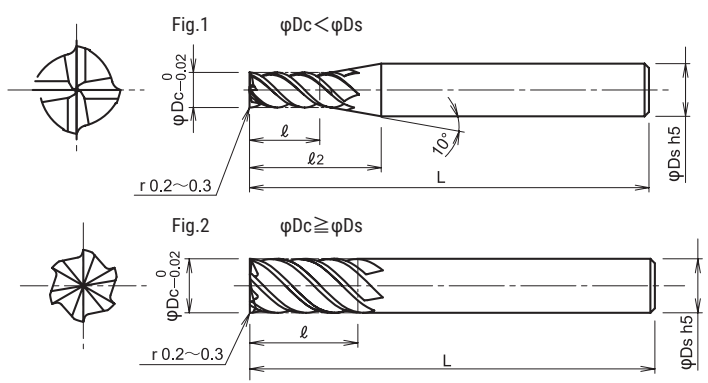
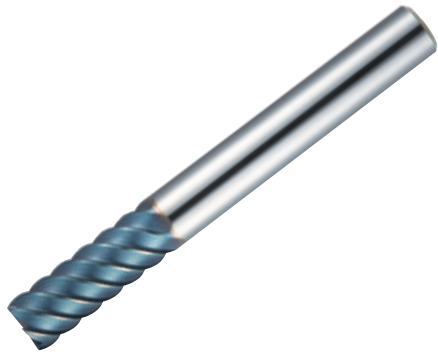

Cat.No.	Stock	No. of Flutes	Dimensions (mm)					Fig.
			φDc	ℓ	ℓ2	L	φDs	
SEHH4030-R02	●	4	3	10	20	60	6	1
SEHH4040-R02	●		4	12	19			
SEHH4050-R02	●		5	15	-			
SEHH6060-R02	●	6	6	20	24	75	8	2
SEHH6070-R02	●		7		-			1
SEHH6080-R02	●		8	-	2			
SEHH6090-R02	●		9	25	29	80	10	1
SEHH6100-R02	●		10	-	-			
SEHH6120-R02	●		12	30	-	100	12	2
SEHH6160-R02	●		16	40	-	110	16	
SEHH6200-R02	●		20	45	-	125	20	

ONE-CUT 70 **SEH Type**

- For High hardened materials up to 70HRC
- Helix angle 50°
- Corner radius type



Gash land



DH
Coating



Shoulder Milling

Roughing

Semi-finishing

Finishing

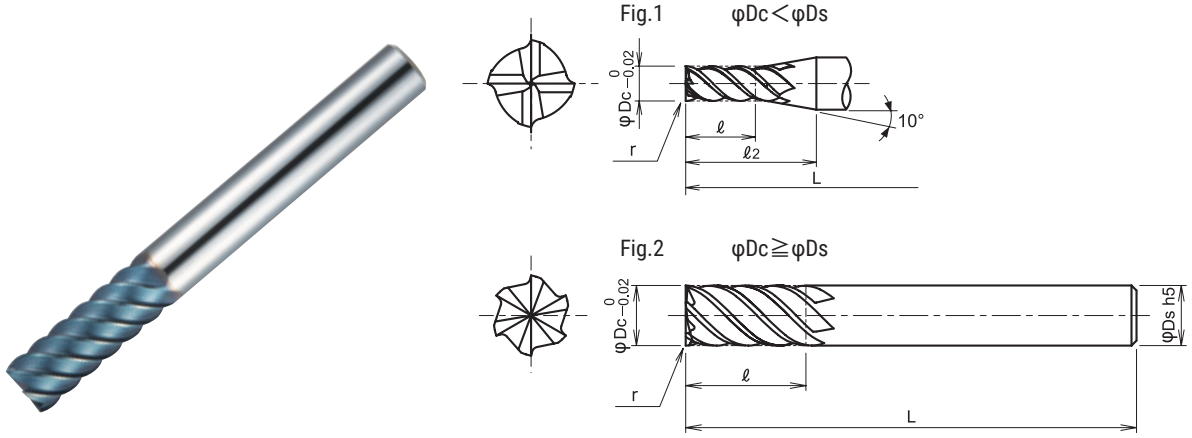

Cat.No.	Stock	No. of Flutes	Dimensions (mm)						Fig.
			r	φDc	ℓ	ℓ2	L	φDs	
SEHH4030-R03	●	4	0.3	3	10	20	60	6	1
SEHH4030-R05	●		0.5						
SEHH4040-R03	●		0.3	4	12	19			
SEHH4040-R05	●		0.5						
SEHH4050-R03	●		0.3	5	15	19			
SEHH4050-R05	●		0.5						
SEHH6060-R03	●	6	0.3	6	20	75	8	2	
SEHH6060-R05	●		0.5						
SEHH6060-R10	●		1						
SEHH6080-R03	●		0.3	8	25	80	10		
SEHH6080-R05	●		0.5						
SEHH6080-R10	●		1						
SEHH6100-R03	●	6	0.3	10	30	100	12	2	
SEHH6100-R05	●		0.5						
SEHH6100-R10	●		1						
SEHH6100-R15	●		1.5						
SEHH6120-R03	●		0.3	12	40	110	16		
SEHH6120-R05	●		0.5						
SEHH6120-R10	●	1							
SEHH6120-R15	●	1.5							
SEHH6160-R03	●	6	0.3	16	45	125	20	2	
SEHH6160-R05	●		0.5						
SEHH6160-R10	●		1						
SEHH6160-R15	●		1.5						
SEHH6200-R03	●		0.3	20	45	125	20		
SEHH6200-R05	●		0.5						
SEHH6200-R10	●	1							
SEHH6200-R15	●	1.5							

ONE-CUT 70**SEH Type**

- For High hardened materials up to 70HRC
- Helix angle 50°
- Medium length of cut

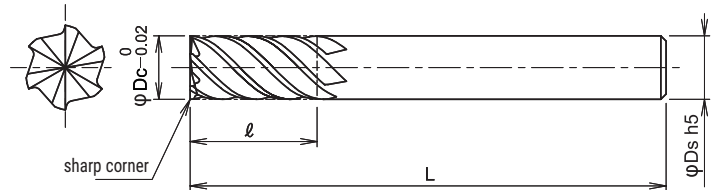
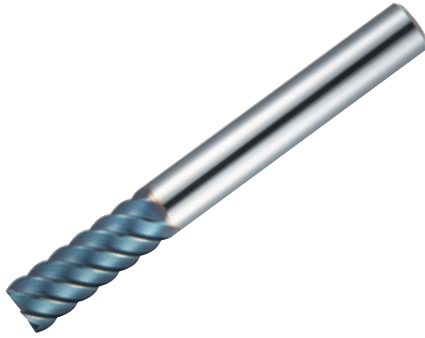

Type	Cat.No.	Stock	No.of Flutes	Dimensions (mm)			
				φD_c	ℓ	L	φD_s
Medium	SEHM6060	●	6	6	20	65	6
	SEHM6080	●		8	28	80	8
	SEHM6100	●		10	35	90	10
	SEHM6120	●		12	45	110	12
	SEHM6160	●		16	55	120	16
	SEHM6200	●		20	60	140	20

ONE-CUT 70 **SEH Type**

- For High hardened materials up to 70HRC
- Helix angle 50°
- Long length of cut

Gash land



DH
Coating

Shoulder Milling

Roughing

Semi-finishing

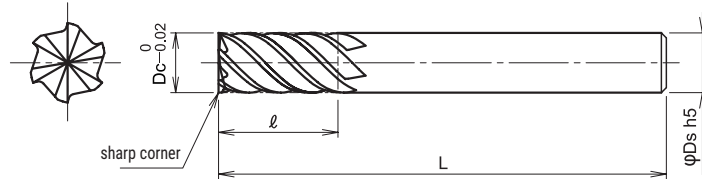
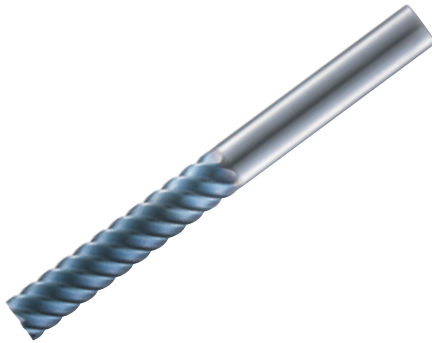
Finishing



Type	Cat.No.	Stock	No. of Flutes	Dimensions (mm)			
				φDc	ℓ	L	φDs
Long	SEHL6060	●	6	6	26	70	6
	SEHL6080	●		8	36	90	8
	SEHL6100	●		10	46	100	10
	SEHL6120	●		12	56	120	12
	SEHL6160	●		16	66	135	16
	SEHL6200	●		20	76	155	20

ONE-CUT 70**SEH Type**

■ SEHS / SEHH / SEHH-R02 / SEHH-R type Recommended cutting conditions

● SIDE CUTTING

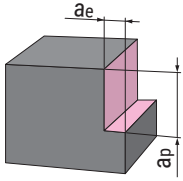
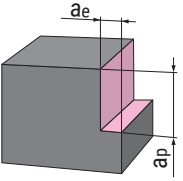
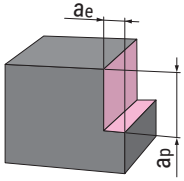
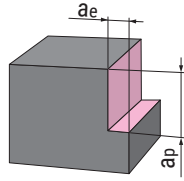
Material	Mold steel (NAK80, HPM1, P21) 38~43HRC		Hardened steel (SKD61, DAC, DHA) 42~52HRC		Hardened steel (SKD11, SLD, DC11) 55~62HRC		HSS (SKH, HAP) 63~70HRC	
Type of machining	 $a_p \leq 1.5D_c$ $a_e \leq 0.05D_c$		 $a_p \leq 1.5D_c$ $a_e \leq 0.04D_c$		 $a_p \leq 1.5D_c$ $a_e \leq 0.04D_c$ (MAX. 0.6mm)		 $a_p \leq 1.5D_c$ $a_e \leq 0.02D_c$ (MAX. 0.4mm)	
ϕD_c (mm)	n (min ⁻¹)	Vf (mm/min)	n (min ⁻¹)	Vf (mm/min)	n (min ⁻¹)	Vf (mm/min)	n (min ⁻¹)	Vf (mm/min)
1	40,000	700	25,000	410	20,000	320	10,000	130
2	24,000	950	15,000	560	12,000	430	6,400	220
3	24,000	1,300	15,000	800	12,000	600	6,000	250
4	18,000	1,800	12,000	1,100	9,500	800	5,100	300
6	12,000	2,200	8,000	1,400	6,500	1,100	3,500	420
8	10,000	2,200	6,000	1,400	5,000	1,100	2,500	420
10	8,000	2,200	5,000	1,400	4,000	1,100	2,000	420
12	6,500	1,900	4,000	1,200	3,300	900	1,700	350
16	5,000	1,480	3,000	930	2,500	700	1,300	260
20	3,800	1,150	2,300	730	2,000	550	1,000	200

Note

1. These cutting conditions are for general guidance.
2. The figures should be adjusted according to machining shape, purpose and rigidity of machine and work clamping.
3. Recommend to down cut with air blow or mist coolant.

ONE-CUT 70**SEH Type**■ **SEHM type Recommended cutting conditions**

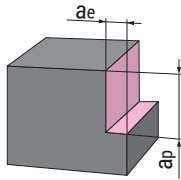
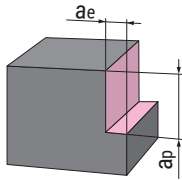
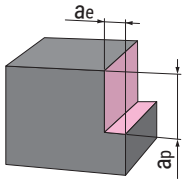
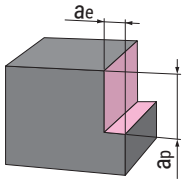
Material	Mold steel (NAK80, HPM1, P21) 38~43HRC		Hardened steel (SKD61, DAC, DHA) 42~52HRC		Hardened steel (SKD11, SLD, DC11) 55~62HRC		HSS (SKH, HAP) 63~70HRC	
Type of machining	 $a_p \leq 2.25D_c$ $a_e \leq 0.03D_c$		 $a_p \leq 2.25D_c$ $a_e \leq 0.025D_c$		 $a_p \leq 2.25D_c$ $a_e \leq 0.025D_c$		 $a_p \leq 2.25D_c$ $a_e \leq 0.01D_c$	
ϕD_c (mm)	n (min ⁻¹)	Vf (mm/min)	n (min ⁻¹)	Vf (mm/min)	n (min ⁻¹)	Vf (mm/min)	n (min ⁻¹)	Vf (mm/min)
6	10,600	1,900	6,400	1,200	5,300	1,000	2,700	320
8	8,000	1,900	4,800	1,200	4,000	1,000	2,000	360
10	6,400	1,900	3,800	1,200	3,200	1,000	1,600	380
12	5,300	1,600	3,200	1,000	2,700	800	1,300	240
16	4,000	1,200	2,400	700	2,000	600	1,000	180
20	3,200	1,000	1,900	600	1,600	500	800	140

Note

1. These cutting conditions are for general guidance.
2. The figures should be adjusted according to machining shape, purpose and rigidity of machine and work clamping.
3. Recommend to down cut with air blow or mist coolant.

ONE-CUT 70**SEH Type**■ **SEHM type Recommended cutting conditions**

Material	Mold steel (NAK80, HPM1, P21) 38~43HRC		Hardened steel (SKD61, DAC, DHA) 42~52HRC		Hardened steel (SKD11, SLD, DC11) 55~62HRC	
Type of machining	 $a_p \leq 3D_c$ $a_e \leq 0.01D_c$		 $a_p \leq 3D_c$ $a_e \leq 0.01D_c$		 $a_p \leq 3D_c$ $a_e \leq 0.01D_c$	
ϕD_c (mm)	n (min ⁻¹)	V_f (mm/min)	n (min ⁻¹)	V_f (mm/min)	n (min ⁻¹)	V_f (mm/min)
6	3,180	760	2,650	480	2,100	380
8	2,390	720	1,990	480	1,590	380
10	1,910	690	1,590	480	1,270	380
12	1,590	670	1,330	480	1,060	380
16	1,190	570	1,000	420	800	340
20	950	510	800	380	640	310

Note

1. These cutting conditions are for general guidance.
2. The figures should be adjusted according to machining shape, purpose and rigidity of machine and work clamping.
3. Recommend to down cut with air blow or mist coolant.

HARD 1 RADIUS**SFSR Type**

HARD 1 RADIUS

Feature 1

Highly Rigid Design for High Efficiency Machining

Feature 2

Suppress Vibration with Variable Helix Angle & Unequal Spacing Teeth Geometry

Feature 3

Special design on center of cutting edge improves cutting performance

Feature 4Applicable for High Spindle Machine & Shrink Fit Holder
Shank diameter tolerance: h5**Feature 5**

Excellent tool life for Hardened Materials with Newly developed grade "DH110"

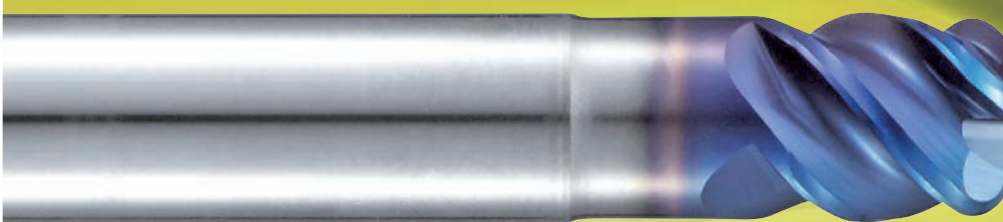
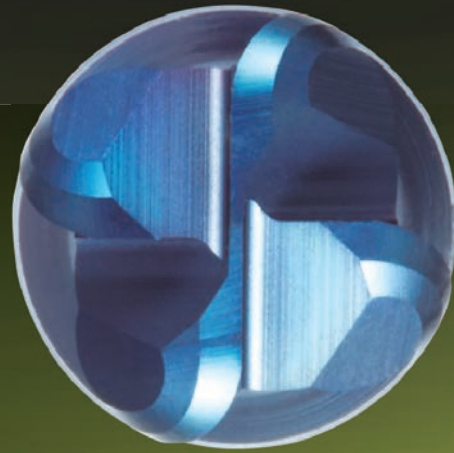

New PVD coating <DH coating>

● Properties of DIJET PVD coating

	DH coating	DV coating	DZ coating(TiAlN)
Hardness(Hv)	3,500~3,700	3,300~3,500	2,800~2,900
Oxidation temperature (°C)	1,100~1,200	1,000~1,100	700~800
Coefficient of friction	0.5	0.65	0.6

HARD 1 RADIUS

- For General steel to Hardened steel
- From roughing to finishing
- Helix angle 50°-52°

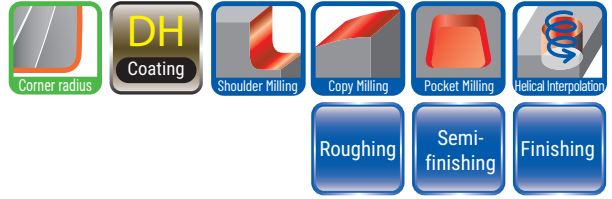

Fig.1 $\varphi D_c < \varphi D_s$

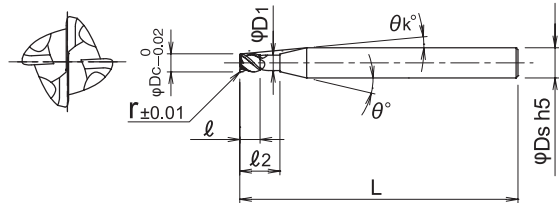
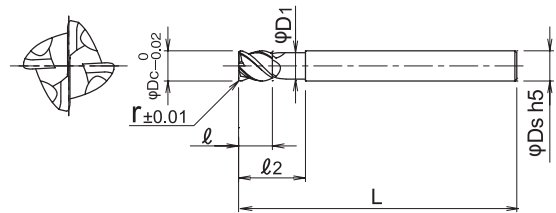

Fig.2 $\varphi D_c = \varphi D_s$



Cat.No.	Stock	Dimensions (mm)									Fig.
		r	φD_c	ℓ	ℓ_2	L	φD_1	θ	θ_k	φD_s	
SFSR4020S04-R05	●	0.5	2	2	4	40	1.9	20°	9.1°	4	1
SFSR4020S06-R05	●								12.6°	6	
SFSR4030S04-R08	●	0.8	3	3	6		2.9		4.4°	4	
SFSR4030S06-R08	●								9.2°	6	
SFSR4040S04-R10	●	1	4	4	8	3.8	—	—	4	2	
SFSR4040S06-R10	●						5.9°	6	1		
SFSR4050S06-R12	●	1.2	5	5	10	50	4.8			20°	2.9°
SFSR4060S06-R10	●	1	6	6	12			5.8	—		
SFSR4060S06-R15	●	1.5									
SFSR4080S08-R10	●	1	8	8	16	60	7.8	—	—	10	2
SFSR4080S08-R20	●	2									
SFSR4100S10-R20	●		3	10	10	20	9.8	—	—	12	12
SFSR4100S10-R30	●										
SFSR4120S12-R20	●	2	12	12	24	11.8	—	—	12	12	
SFSR4120S12-R30	●	3									

HARD 1 RADIUS SFSR Type

- For General steel to Hardened steel
- From roughing to finishing
- Helix angle 50°-52°
- Corner radius accuracy : ±0.005

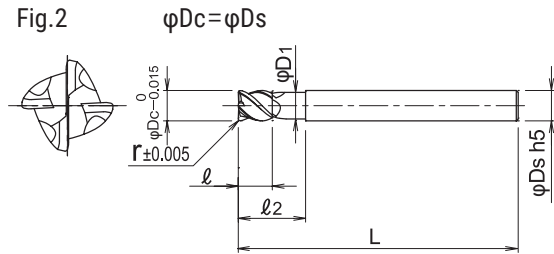
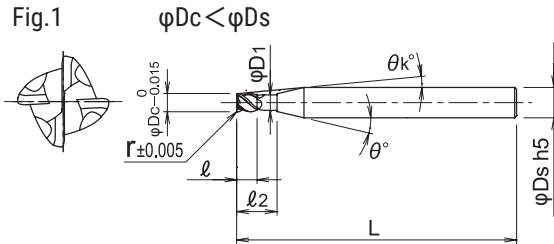
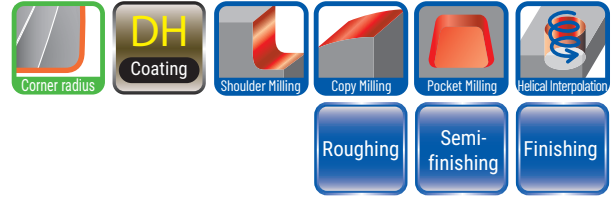

Cat.No.	Stock	Dimensions (mm)									Fig.								
		r	φDc	ℓ	ℓ2	L	φD1	θ	θk	φDs									
SFSR4020S06-R05-06	●	0.5	2	2	6	60	1.9	20°	10.27°	6	1								
SFSR4030S06-R08-09	●	0.8	3	3	9		2.9		6.91°										
SFSR4040S06-R10-12	●	1	4	4	12		3.8		4.15°										
SFSR4050S06-R12-15	●	1.2	5	5	15		4.7		1.88°										
SFSR4060S06-R05-18	●	0.5	6	6	18	90	5.7			6									
SFSR4060S06-R05-30	●				30														
SFSR4060S06-R10-18	●	1			18							60							
SFSR4060S06-R10-30	●	1			30							90							
SFSR4060S06-R15-18	●	1.5			18														
SFSR4060S06-R15-30	●				30														
SFSR4080S08-R05-24	●	0.5			8							8	24	75	7.6			8	
SFSR4080S08-R05-40	●												40	100					
SFSR4080S08-R10-24	●	1				24	75												
SFSR4080S08-R10-40	●					40	100												
SFSR4080S08-R20-24	●	2					24	75											
SFSR4080S08-R20-40	●						40	100											
SFSR4100S10-R05-30	●	0.5	10	10			30	80					9.5			10	2		
SFSR4100S10-R05-50	●						50	110											
SFSR4100S10-R10-30	●	1					30	80											
SFSR4100S10-R10-50	●						50	110											
SFSR4100S10-R20-30	●	2					30	80											
SFSR4100S10-R20-50	●						50	110											
SFSR4100S10-R30-30	●	3					30	80											
SFSR4100S10-R30-50	●						50	110											
SFSR4120S12-R05-36	●	0.5	12	12			36	100	11.5			12							
SFSR4120S12-R05-60	●						60	120											
SFSR4120S12-R10-36	●	1					36	100											
SFSR4120S12-R10-60	●						60	120											
SFSR4120S12-R20-36	●	2					36	100											
SFSR4120S12-R20-60	●						60	120											
SFSR4120S12-R30-36	●	3					36	100											
SFSR4120S12-R30-60	●						60	120											

SFSR Type

HARD 1 RADIUS

- For General steel to Hardened steel
- From roughing to finishing
- Helix angle 50°-52°
- Corner radius R0.2

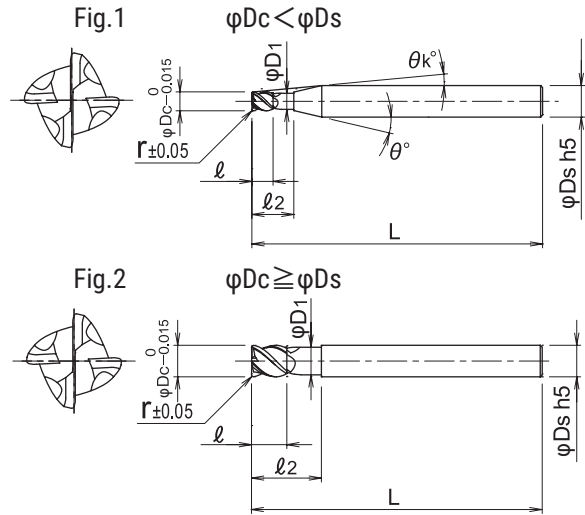
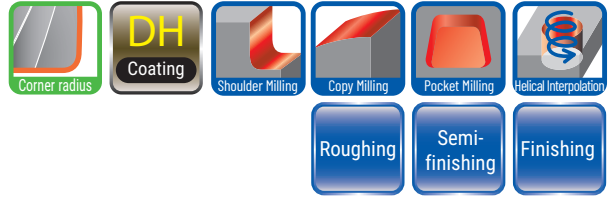

Cat.No.	Stock	Dimensions (mm)									Fig.
		r	φDc	ℓ	ℓ2	L	φD1	θ	θk	φDs	
SFSR4020S06-R02-06	●	0.2	2	2	6	60	1.9	20°	10.03°	6	1
SFSR4030S06-R02-09	●		3	3	9		2.9		6.62°		
SFSR4040S06-R02-12	●		4	4	12		3.8		3.93°		
SFSR4050S06-R02-15	●		5	5	15		4.7		1.77°		
SFSR4060S06-R02-18	●		6	6	18		5.7				
SFSR4080S08-R02-24	●		8	8	24	75	7.6	-	-	8	2
SFSR4100S10-R02-30	●		10	10	30	80	9.5			10	
SFSR4120S12-R02-36	●		12	12	36	100	11.5			12	

HARD 1 RADIUS**SFSR Type**

■ SFSR type Recommended cutting conditions

● Face milling - Roughing

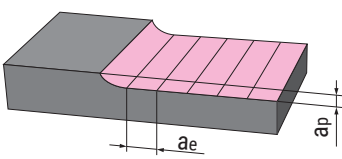
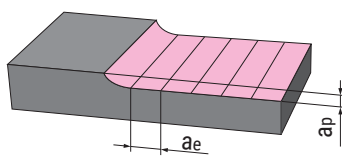
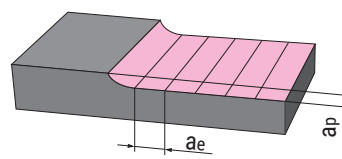
Material	Carbon steel (S50C, S55C) below 250HB		Alloy steel, Tool steel, Mold steel (SKD, SKH, NAK) below 45HRC		Stainless steel (SUS304)	
Type of machining	 $a_p \leq 0.3\text{mm}$ ($\phi 2 \pm 0.15\text{mm}$) $a_e \leq 0.33D_c$		 $a_p \leq 0.3\text{mm}$ ($\phi 2 \pm 0.15\text{mm}$) $a_e \leq 0.33D_c$		 $a_p \leq 0.15\text{mm}$ $a_e \leq 0.33D_c$	
ϕD_c (mm)	n (min ⁻¹)	V_f (mm/min)	n (min ⁻¹)	V_f (mm/min)	n (min ⁻¹)	V_f (mm/min)
2	24,000	7,000	24,000	7,000	25,000	2,500
3	17,000	7,000	17,000	7,000	17,000	3,000
4	13,000	8,000	13,000	8,000	13,000	3,500
5	10,000	9,000	10,000	9,000	10,500	4,000
6	8,500	10,000	8,500	10,000	8,600	4,200
8	6,500	10,000	6,500	10,000	6,500	4,200
10	5,200	10,000	5,200	10,000	4,500	4,200
12	4,300	10,000	4,300	10,000	3,000	4,200

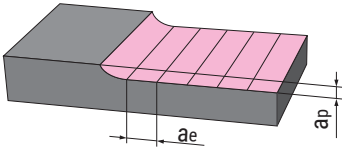
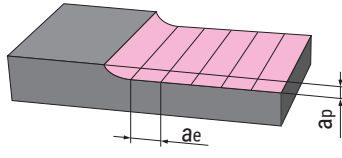
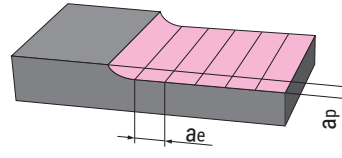
Material	Hardened steel (SKD61, DAC, DHA) 42~52HRC		Hardened steel (SKD11, SKH51, SLD) 55~62HRC		Hardened steel (SKH, HAP) 63~70HRC	
Type of machining	 $a_p \leq 0.15\text{mm}$ $a_e \leq 0.33D_c$		 $a_p \leq 0.15\text{mm}$ $a_e \leq 0.33D_c$		 $a_p \leq 0.15\text{mm}$ $a_e \leq 0.33D_c$	
ϕD_c (mm)	n (min ⁻¹)	V_f (mm/min)	n (min ⁻¹)	V_f (mm/min)	n (min ⁻¹)	V_f (mm/min)
2	16,000	2,300	9,000	1,700	3,000	600
3	12,500	3,000	7,300	1,900	3,000	750
4	11,000	3,500	6,500	2,100	3,000	1,000
5	9,500	4,800	6,200	2,300	3,000	1,200
6	8,000	5,500	6,000	2,500	3,200	1,400
8	6,000	6,000	4,300	2,300	2,500	1,500
10	4,800	6,000	3,300	2,500	2,000	1,600
12	4,000	7,500	2,500	2,500	1,500	1,700

Note

1. These cutting conditions are for general guidance.
2. The figures should be adjusted according to machining shape, purpose and rigidity of machine and work clamping.
3. If rpm available is lower than that recommended, reduce the feed rate proportionately.
4. Recommend to down cut with air blow or mist coolant.
5. Wet cutting is recommended for stainless steel.

HARD 1 RADIUS**SFSR Type**■ **SFSR type Recommended cutting conditions**● **Face milling - Finishing**

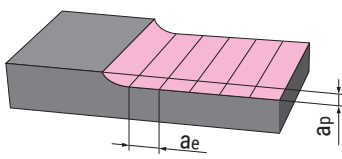
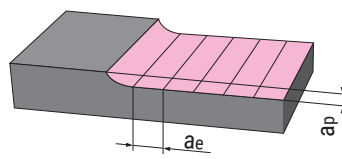
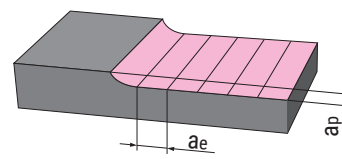
Material	Carbon steel (S50C, S55C) below 250HB		Alloy steel, Tool steel, Mold steel (SKD, SKH, NAK) below 45HRC		Stainless steel (SUS304)	
Type of machining	 $a_p \leq 0.15\text{mm}$ $a_e \leq 0.1D_c$		 $a_p \leq 0.15\text{mm}$ $a_e \leq 0.1D_c$		 $a_p \leq 0.15\text{mm}$ $a_e \leq 0.1D_c$	
ϕD_c (mm)	n (min ⁻¹)	Vf (mm/min)	n (min ⁻¹)	Vf (mm/min)	n (min ⁻¹)	Vf (mm/min)
2	30,000	2,000	30,000	2,000	30,000	2,000
3	20,000	2,000	20,000	2,000	20,000	2,000
4	15,000	2,000	15,000	2,000	15,000	2,000
5	12,000	2,000	12,000	2,000	12,000	2,000
6	10,000	2,000	10,000	2,000	10,000	2,000
8	7,500	2,000	7,500	2,000	7,500	2,000
10	6,000	1,900	6,000	1,900	5,000	1,500
12	5,000	1,800	5,000	1,800	3,000	1,000

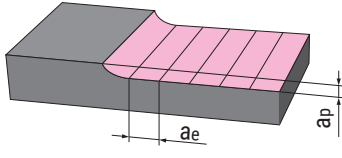
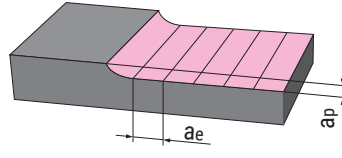
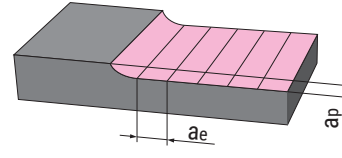
Material	Hardened steel (SKD61, DAC, DHA) 42~52HRC		Hardened steel (SKD11, SKH51, SLD) 55~62HRC		Hardened steel (SKH, HAP) 63~70HRC	
Type of machining	 $a_p \leq 0.1\text{mm}$ $a_e \leq 0.1D_c$		 $a_p \leq 0.1\text{mm}$ $a_e \leq 0.1D_c$		 $a_p \leq 0.05\text{mm}$ $a_e \leq 0.1D_c$	
ϕD_c (mm)	n (min ⁻¹)	Vf (mm/min)	n (min ⁻¹)	Vf (mm/min)	n (min ⁻¹)	Vf (mm/min)
2	20,000	1,300	13,000	900	9,000	400
3	14,000	1,100	9,000	700	6,000	350
4	11,000	950	7,000	550	4,700	300
5	9,500	900	5,700	550	3,800	300
6	8,000	800	4,700	450	3,200	250
8	6,000	700	3,500	400	2,500	250
10	5,000	650	2,800	350	2,000	200
12	4,000	650	2,400	350	1,600	200

Note

1. These cutting conditions are for general guidance.
2. The figures should be adjusted according to machining shape, purpose and rigidity of machine and work clamping.
3. If rpm available is lower than that recommended, reduce the feed rate proportionately.
4. Recommend to down cut with air blow or mist coolant.
5. Wet cutting is recommended for stainless steel.

HARD 1 RADIUS**SFSR Type**

■ SFSR type Recommended cutting conditions

● Side milling - Roughing

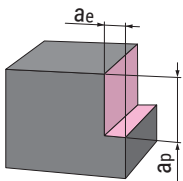
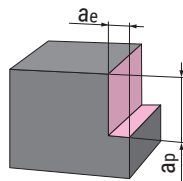
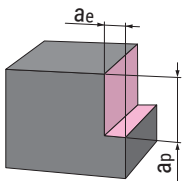
Material	Carbon steel (S50C, S55C) below 250HB		Alloy steel, Tool steel, Mold steel (SKD, SKH, NAK) below 45HRC		Stainless steel (SUS304)	
Type of machining	 $a_p \leq 0.6D_c$ $a_e \leq 0.08D_c$		 $a_p \leq 0.6D_c$ $a_e \leq 0.08D_c$		 $a_p \leq 0.6D_c$ $a_e \leq 0.04D_c$	
ϕD_c (mm)	n (min ⁻¹)	V_f (mm/min)	n (min ⁻¹)	V_f (mm/min)	n (min ⁻¹)	V_f (mm/min)
2	24,000	950	24,000	950	3,200	2,500
3	24,000	1,300	24,000	1,300	2,700	2,200
4	18,000	1,800	18,000	1,800	2,300	2,000
5	15,000	2,000	15,000	2,000	2,000	1,900
6	12,000	2,200	12,000	2,200	1,800	1,800
8	10,000	2,200	10,000	2,200	1,300	1,300
10	8,000	2,200	8,000	2,200	1,000	1,000
12	6,500	1,900	6,500	1,900	800	800

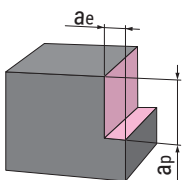
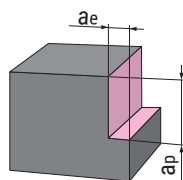
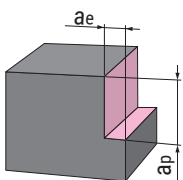
Material	Hardened steel (SKD61, DAC, DHA) 42~52HRC		Hardened steel (SKD11, SKH51, SLD) 55~62HRC		Hardened steel (SKH, HAP) 63~70HRC	
Type of machining	 $a_p \leq 0.6D_c$ $a_e \leq 0.08D_c$		 $a_p \leq 0.6D_c$ $a_e \leq 0.08D_c$		 $a_p \leq 0.6D_c$ $a_e \leq 0.08D_c$	
ϕD_c (mm)	n (min ⁻¹)	V_f (mm/min)	n (min ⁻¹)	V_f (mm/min)	n (min ⁻¹)	V_f (mm/min)
2	13,000	1,000	12,000	1,000	6,400	600
3	13,000	1,300	11,000	1,200	6,000	600
4	11,000	1,500	9,000	1,200	5,100	550
5	9,000	1,600	7,200	1,200	4,200	550
6	7,500	1,800	6,000	1,200	3,500	650
8	5,500	2,200	4,500	1,200	2,500	650
10	4,500	2,500	3,600	1,400	2,000	600
12	3,800	3,000	3,000	1,400	1,700	600

Note

1. These cutting conditions are for general guidance.
2. The figures should be adjusted according to machining shape, purpose and rigidity of machine and work clamping.
3. If rpm available is lower than that recommended, reduce the feed rate proportionately.
4. Recommend to down cut with air blow or mist coolant.
5. Wet cutting is recommended for stainless steel.

HARD 1 RADIUS**SFSR Type**■ **SFSR type Recommended cutting conditions**● **Side milling - Finishing**

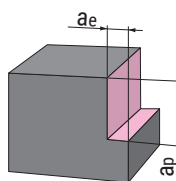
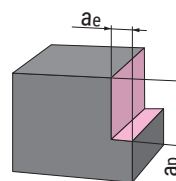
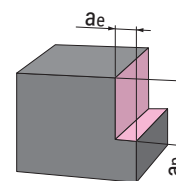
Material	Carbon steel (S50C, S55C) below 250HB		Alloy steel, Tool steel, Mold steel (SKD, SKH, NAK) below 45HRC		Stainless steel (SUS304)	
Type of machining	 $a_p \leq 0.3\text{mm}$ $a_e \leq 0.1\text{mm}$		 $a_p \leq 0.3\text{mm}$ $a_e \leq 0.1\text{mm}$		 $a_p \leq 0.3\text{mm}$ $a_e \leq 0.1\text{mm}$	
ϕDc (mm)	n (min ⁻¹)	V_f (mm/min)	n (min ⁻¹)	V_f (mm/min)	n (min ⁻¹)	V_f (mm/min)
2	40,000	4,500	40,000	4,500	40,000	7,500
3	29,000	4,000	29,000	4,000	28,000	5,500
4	22,000	4,000	22,000	4,000	21,000	4,500
5	18,000	4,000	18,000	4,000	17,000	4,000
6	15,000	3,700	15,000	3,700	14,000	3,500
8	11,000	2,800	11,000	2,800	11,000	3,000
10	8,900	2,600	8,900	2,600	9,000	2,600
12	7,400	2,300	7,400	2,300	7,500	2,200

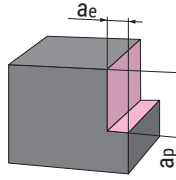
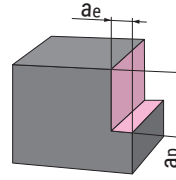
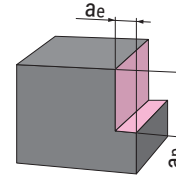
Material	Hardened steel (SKD61, DAC, DHA) 42~52HRC		Hardened steel (SKD11, SKH51, SLD) 55~62HRC		Hardened steel (SKH, HAP) 63~70HRC	
Type of machining	 $a_p \leq 0.3\text{mm}$ $a_e \leq 0.1\text{mm}$		 $a_p \leq 0.2\text{mm}$ $a_e \leq 0.1\text{mm}$		 $a_p \leq 0.1\text{mm}$ $a_e \leq 0.1\text{mm}$	
ϕDc (mm)	n (min ⁻¹)	V_f (mm/min)	n (min ⁻¹)	V_f (mm/min)	n (min ⁻¹)	V_f (mm/min)
2	40,000	2,500	30,000	2,000	23,000	550
3	26,500	2,000	20,000	1,500	15,000	450
4	20,000	1,800	15,000	1,200	12,000	400
5	16,000	1,500	12,000	1,100	9,500	380
6	13,500	1,300	10,000	900	8,000	350
8	10,000	1,000	7,500	700	6,000	280
10	8,000	800	6,000	600	5,000	280
12	6,500	700	5,000	500	4,000	280

Note

1. These cutting conditions are for general guidance.
2. The figures should be adjusted according to machining shape, purpose and rigidity of machine and work clamping.
3. If rpm available is lower than that recommended, reduce the feed rate proportionately.
4. Recommend to down cut with air blow or mist coolant.
5. Wet cutting is recommended for stainless steel.

HARD 1 RADIUS**SFSR Type**■ **SFSR type Recommended cutting conditions**● **Slot milling**

Material	Carbon steel (S50C, S55C) below 250HB		Alloy steel, Tool steel, Mold steel (SKD, SKH, NAK) below 45HRC		Stainless steel (SUS304)	
Type of machining	 $a_p \leq 0.3D_c$ $a_e = D_c$		 $a_p \leq 0.3D_c$ $a_e = D_c$		 $a_p \leq 0.25D_c$ $a_e = D_c$	
ϕD_c (mm)	n (min ⁻¹)	V_f (mm/min)	n (min ⁻¹)	V_f (mm/min)	n (min ⁻¹)	V_f (mm/min)
2	11,000	650	11,000	650	2,500	190
3	9,500	750	9,500	750	2,300	180
4	8,500	800	8,500	800	2,000	170
5	7,600	1,000	7,600	1,000	1,800	160
6	6,600	1,100	6,600	1,100	1,500	150
8	5,000	1,200	5,000	1,200	1,100	130
10	4,000	1,200	4,000	1,200	850	130
12	3,300	1,300	3,300	1,300	700	130

Material	Hardened steel (SKD61, DAC, DHA) 42~52HRC		Hardened steel (SKD11, SKH51, SLD) 55~62HRC		Hardened steel (SKH, HAP) 63~70HRC	
Type of machining	 $a_p \leq 0.3D_c$ $a_e = D_c$		 $a_p \leq 0.3D_c$ $a_e = D_c$		 $a_p \leq 0.3D_c$ $a_e = D_c$	
ϕD_c (mm)	n (min ⁻¹)	V_f (mm/min)	n (min ⁻¹)	V_f (mm/min)	n (min ⁻¹)	V_f (mm/min)
2	9,000	400	5,500	240	5,500	230
3	8,000	500	5,000	300	4,800	270
4	7,500	550	4,200	350	4,000	320
5	6,800	650	3,900	400	3,800	400
6	5,800	700	3,500	500	3,200	480
8	4,300	750	2,700	550	2,300	450
10	3,400	900	2,200	620	1,800	470
12	2,800	1,000	1,800	700	1,500	530

Note

1. These cutting conditions are for general guidance.
2. The figures should be adjusted according to machining shape, purpose and rigidity of machine and work clamping.
3. If rpm available is lower than that recommended, reduce the feed rate proportionately.
4. Recommend to down cut with air blow or mist coolant.
5. Wet cutting is recommended for stainless steel.
6. Recommended ramping angle is up to 45° for cutting general steel.
In case of Stainless steel & Hardened steel, recommended ramping angle is up to 5° only.

HARD 1 BALL**SFSB Type****HARD 1 BALL****Feature 1**

Newly developed short length type solid carbide ball nose endmill that has high tool rigidity for stability and reliability.

Feature 2

Secure Radius Accuracy : $\pm 0.005\text{mm}$
For better surface finish,
improving chipping resistance during machining

Feature 3

Shank diameter tolerance : h5
Suitable for shrink fit holders

**Feature 4**

Excellent tool life for Hardened Materials with
Newly developed grade "DH110"

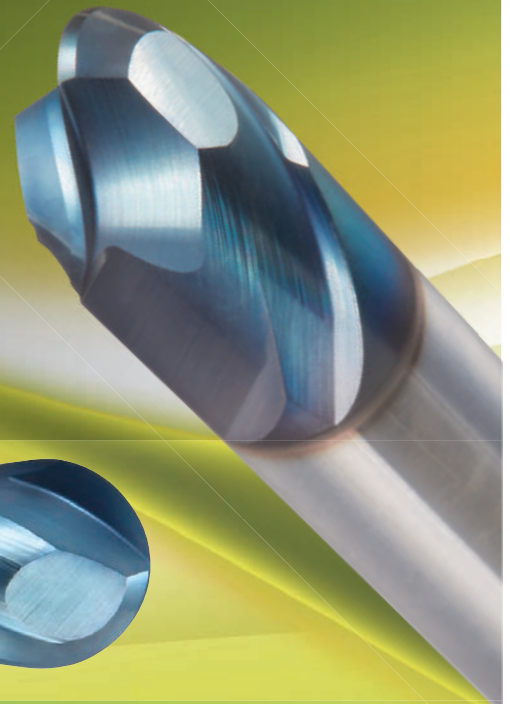
Radius Accuracy: $\pm 0.005\text{mm}$ **New PVD coating <DH coating>****● Properties of DIJET PVD coating**

	DH coating	DV coating	DZ coating(TiAlN)
Hardness(Hv)	3,500~3,700	3,300~3,500	2,800~2,900
Oxidation temperature (°C)	1,100~1,200	1,000~1,100	700~800
Coefficient of friction	0.5	0.65	0.6

HARD 1 BALL SFSB Type

- For General steel to Hardened steel
- From roughing to finishing
- Helix angle 30°

DH
Coating

Slotting

Copy Milling

Pocket Milling

Roughing

Semi-finishing

Finishing

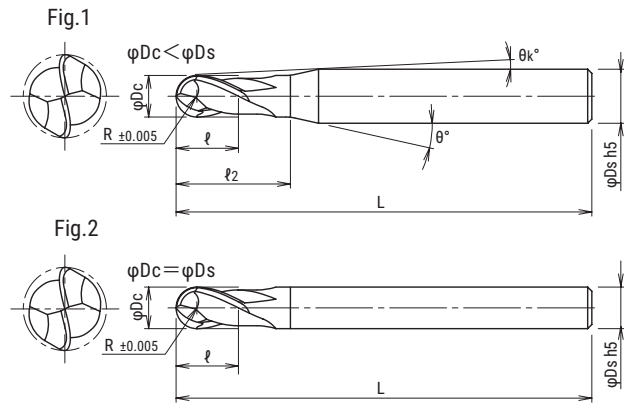
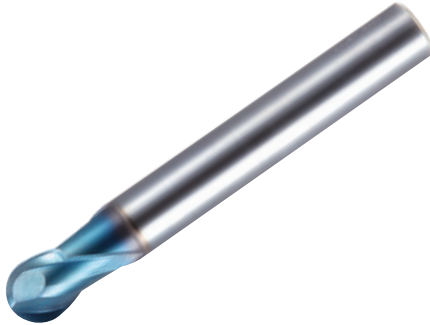

Cat.No.	Stock	Dimensions (mm)								Fig.
		R	ϕD_c	ℓ	ℓ_2	L	θ	θ_k	ϕD_s	
SFSB2010	●	0.5	1	1	1.5	40	12°	10.49°	4	1
SFSB2010-S6	●							11.04°	6	
SFSB2020	●	1	2	2	2.5		10°	7.86°	4	
SFSB2020-S6	●							8.8°	6	
SFSB2030	●	1.5	3	3	4		10°	5.29°	4	
SFSB2030-S6	●							7.69°	6	
SFSB2040	●	2	4	4	—	8°	—	4	2	
SFSB2040-S6	●				5		5.59°			
SFSB2050	●	2.5	5	5	6	50	5°	2.79°	6	1
SFSB2060	●	3	6	6	—					
SFSB2080	●	4	8	8	—	60	—	10		
SFSB2100	●	5	10	10	—			12		
SFSB2120	●	6	12	12	—	—	—	—	—	

HARD 1 BALL **SFSB Type**

■ SFSB type Recommended cutting conditions

● Roughing - Semi finishing

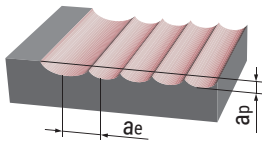
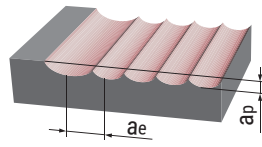
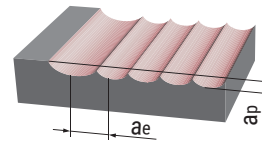
Material		Carbon steel (S50C, S55C) below 250HB	Alloy steel, Tool steel, Mold steel (SKD, SKH, NAK) below 45HRC	Hardened steel (SKD61, DAC, DHA) 42~52HRC			
Type of machining		 $a_p \leq 0.1D_c$ $a_e \leq 0.3D_c$	 $a_p \leq 0.1D_c$ $a_e \leq 0.3D_c$	 $a_p \leq 0.1D_c$ (MAX 0.5mm) $a_e \leq 0.3D_c$			
R (mm)	ϕD_c (mm)	n (min ⁻¹)	Vf (mm/min)	n (min ⁻¹)	Vf (mm/min)	n (min ⁻¹)	Vf (mm/min)
0.5	1	31,800	1,590	31,800	1,590	30,200	1,210
1	2	23,900	1,910	23,900	1,910	22,300	1,560
1.5	3	19,100	2,480	19,100	2,290	18,000	1,800
2	4	14,300	2,290	14,300	2,150	13,500	1,620
2.5	5	11,500	2,190	11,500	2,070	10,800	1,620
3	6	9,500	2,090	9,500	1,900	9,000	1,620
4	8	7,200	1,940	7,200	1,800	6,800	1,500
5	10	5,700	1,820	5,700	1,710	5,400	1,460
6	12	4,800	1,540	4,800	1,440	4,500	1,220

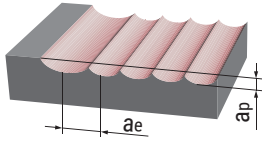
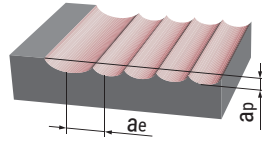
Material		Hardened steel (SKD11, SKH51, SLD) 55~62HRC	Hardened steel (SKH, HAP) 63~70HRC		
Type of machining		 $a_p \leq 0.05D_c$ (MAX 0.3mm) $a_e \leq 0.15D_c$	 $a_p \leq 0.05D_c$ (MAX 0.3mm) $a_e \leq 0.15D_c$		
R (mm)	ϕD_c (mm)	n (min ⁻¹)	Vf (mm/min)	n (min ⁻¹)	Vf (mm/min)
0.5	1	28,600	1,140	27,100	810
1	2	19,100	1,150	17,500	700
1.5	3	17,000	1,360	14,900	890
2	4	12,700	1,270	11,100	890
2.5	5	10,200	1,220	8,900	890
3	6	8,500	1,280	7,400	890
4	8	6,400	1,280	5,600	840
5	10	5,100	1,280	4,500	900
6	12	4,200	1,050	3,700	740

Note

1. These cutting conditions are for general guidance. In case of ramping angle over 15° reduce cutting conditions by 70%.
2. The figures should be adjusted according to machining shape, purpose and rigidity of machine and work clamping.
3. If rpm available is lower than that recommended, reduce the feed rate proportionately.

HARD 1 BALL**SFSB Type**

■ SFSB type Recommended cutting conditions

● Finishing

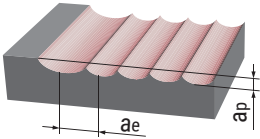
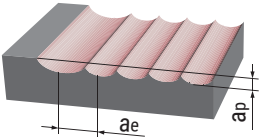
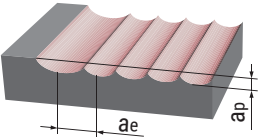
Material		Carbon steel (S50C, S55C) below 250HB		Alloy steel, Tool steel, Mold steel (SKD, SKH, NAK) below 45HRC		Hardened steel (SKD61, DAC, DHA) 42~52HRC	
Type of machining		 $a_p \leq 0.05D_c$ $a_e \leq 0.02D_c$		 $a_p \leq 0.05D_c$ $a_e \leq 0.02D_c$		 $a_p \leq 0.05D_c$ $a_e \leq 0.02D_c$	
R (mm)	ϕD_c (mm)	n (min ⁻¹)	Vf (mm/min)	n (min ⁻¹)	Vf (mm/min)	n (min ⁻¹)	Vf (mm/min)
0.5	1	38,200	3,440	38,200	3,440	35,000	2,450
1	2	27,100	3,250	27,100	3,250	25,500	2,550
1.5	3	21,200	3,390	21,200	3,180	20,200	2,630
2	4	15,900	3,340	15,900	3,180	15,100	2,270
2.5	5	12,700	2,670	12,700	2,540	12,100	2,420
3	6	10,600	2,860	10,600	2,650	10,100	2,530
4	8	8,000	2,560	8,000	2,400	7,600	2,280
5	10	6,400	2,370	6,400	2,240	6,000	1,920
6	12	5,300	1,960	5,300	1,860	5,000	1,600

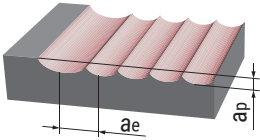
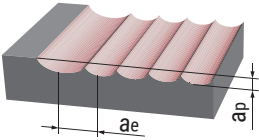
Material		Hardened steel (SKD11, SKH51, SLD) 55~62HRC		Hardened steel (SKH, HAP) 63~70HRC	
Type of machining		 $a_p \leq 0.05D_c$ $a_e \leq 0.02D_c$		 $a_p \leq 0.03D_c$ $a_e \leq 0.02D_c$	
R (mm)	ϕD_c (mm)	n (min ⁻¹)	Vf (mm/min)	n (min ⁻¹)	Vf (mm/min)
0.5	1	31,800	1,590	30,200	1,210
1	2	22,300	2,010	19,100	1,530
1.5	3	19,100	2,290	15,900	1,910
2	4	14,300	2,150	11,900	1,790
2.5	5	11,500	2,070	9,500	1,710
3	6	9,500	1,900	8,000	1,600
4	8	7,200	1,800	6,000	1,200
5	10	5,700	1,710	4,800	1,200
6	12	4,800	1,440	4,000	1,000

Note

1. These cutting conditions are for general guidance. In case of ramping angle over 15° reduce cutting conditions by 70%.
2. The figures should be adjusted according to machining shape, purpose and rigidity of machine and work clamping.
3. If rpm available is lower than that recommended, reduce the feed rate proportionately.

ONE CUT BALL 70**DH-OCHB Type**

One-Cut Ball 70

UP TO 70HRC

4-flute high-efficiency
carbide ball nose end mill

DH-OCHB Type

Anti-vibration with High rigidity
& Unequal Spacing Teeth Geometry

Helix angle 45°,
Low cutting force /
High cutting performance

Excellent tool life for
Hardened Materials with
Newly developed "DH coating"



Special edge geometry in
center enables smooth chip
ejection and control
clogging of chips, allows
stable machining.

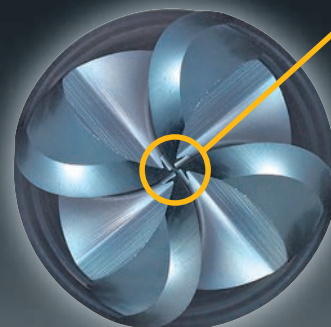

New PVD coating <DH coating>

● Properties of DIJET PVD coating

	DH coating	DV coating	DZ coating (TiAlN)	DX coating (TiCN)	JC coating (TiN)
Hardness (Hv)	3,500~3,700	3,300~3,500	2,800~2,900	2,500~2,600	2,100~2,200
Oxidation temperature (°C)	1,100~1,200	1,000~1,100	700~800	300~400	400~500
Coefficient of friction	0.5	0.65	0.6	0.45	0.45

ONE CUT BALL 70 DH-OCHB Type

- For General steel to Hardened steel
- From roughing to finishing
- Helix angle 45°

DH
Coating

Slotting

Copy Milling

Pocket Milling

Semi-finishing

Finishing

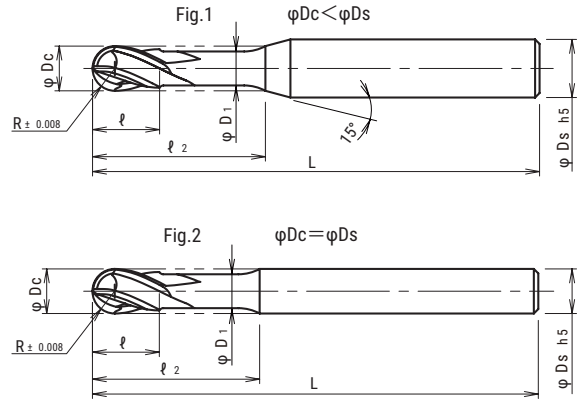

Cat.No.	Stock	Dimensions (mm)							Fig.
		R	φDc	ℓ	ℓ2	L	φD1	φDs	
DH-OCHB4010S04	●	0.5	1	1.5	3	50	0.95	4	1
DH-OCHB4010S06	●	0.5	1	1.5	3		0.95	6	
DH-OCHB4020S04	●	1	2	3	6		1.9	4	
DH-OCHB4020S06	●	1	2	3	6		1.9	6	
DH-OCHB4030	●	1.5	3	4.5	9	70	2.9	6	2
DH-OCHB4040	●	2	4	6	12		3.8		
DH-OCHB4050	●	2.5	5	7.5	15		4.8		
DH-OCHB4060	●	3	6	9	18	90	5.7	100	
DH-OCHB4080	●	4	8	12	24	7.6	8		
DH-OCHB4100	●	5	10	15	30	9.5	10		
DH-OCHB4120	●	6	12	18	36	110	11.4	12	

■ Tolerance (mm)

R of ball nose	Tolerance of R	Tolerance of Dc
R0.5~R1	±0.005	0 -0.010
R1.5~R2	±0.008	0 -0.010
R2.5~R6	±0.008	0 -0.015

ONE CUT BALL 70 **DH-OCHB Type**

■ **DH-OCHB type Recommended cutting conditions**

● **Finishing**

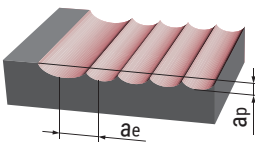
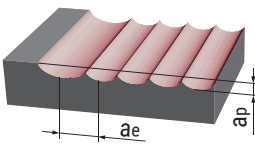
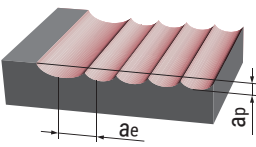
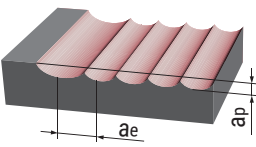
Material		Alloy steel, Tool steel, Mold steel (SKD, SKH, NAK) below 45HRC		Hardened steel (SKD61, DAC, DHA) 42~52HRC		Hardened steel (SKD11, SLD, DC11) 55~62HRC		Hardened steel (SKH, HAP) 63~70HRC	
Type of machining		 $a_p \leq 0.03D_c$ $a_e \leq 0.03D_c$		 $a_p \leq 0.03D_c$ $a_e \leq 0.03D_c$		 $a_p \leq 0.03D_c$ $a_e \leq 0.03D_c$		 $a_p \leq 0.03D_c$ $a_e \leq 0.03D_c$	
R (mm)	ϕD_c (mm)	n (min ⁻¹)	Vf (mm/min)	n (min ⁻¹)	Vf (mm/min)	n (min ⁻¹)	Vf (mm/min)	n (min ⁻¹)	Vf (mm/min)
0.5	1	30,000	1,600	30,000	1,400	30,000	1,200	30,000	800
1	2	30,000	3,200	30,000	2,000	25,500	2,000	19,000	1,000
1.5	3	25,500	4,000	21,200	3,000	17,000	2,000	12,700	1,000
2	4	19,100	4,000	15,900	3,000	12,700	2,000	9,500	1,000
2.5	5	15,300	4,000	12,700	3,000	10,200	2,000	7,600	1,000
3	6	12,700	4,000	10,600	3,000	8,500	2,000	6,400	1,000
4	8	9,500	4,000	8,000	3,000	6,400	2,000	4,800	1,000
5	10	7,600	4,000	6,400	3,000	5,100	2,000	3,800	1,000
6	12	6,400	4,000	5,300	3,000	4,200	2,000	3,200	1,000

■ **DH-OCHB type Recommended cutting conditions**

● **Roughing & Semi-finishing**

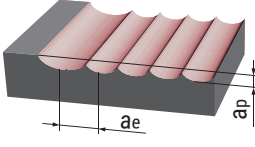
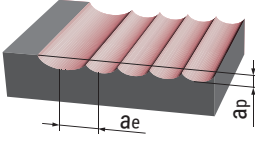
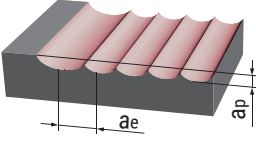
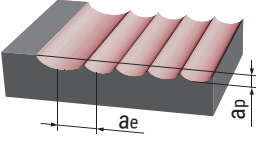
Material		Alloy steel, Tool steel, Mold steel (SKD, SKH, NAK) below 45HRC		Hardened steel (SKD61, DAC, DHA) 42~52HRC		Hardened steel (SKD11, SLD, DC11) 55~62HRC		Hardened steel (SKH, HAP) 63~70HRC					
Type of machining		 $a_p \leq 1.2D_c$ $a_e \leq 0.2D_c$		 $a_p \leq 1.2D_c$ $a_e \leq 0.2D_c$		 $a_p \leq 1.2D_c$ $a_e \leq 0.2D_c$		 $a_p \leq 1.0D_c$ $a_e \leq 0.1D_c$					
R (mm)	ϕD_c (mm)	n (min ⁻¹)	Vf (mm/min)	$a_p \times a_e$	n (min ⁻¹)	Vf (mm/min)	$a_p \times a_e$	n (min ⁻¹)	Vf (mm/min)	$a_p \times a_e$	n (min ⁻¹)	Vf (mm/min)	$a_p \times a_e$
0.5	1	30,000	1,500	0.024	30,000	1,400	0.024	30,000	1,200	0.02	28,800	750	0.006
1	2	28,600	3,000	0.095	23,800	2,250	0.095	19,100	1,500	0.08	14,400	750	0.025
1.5	3	19,100	3,000	0.22	15,900	2,250	0.22	12,700	1,500	0.18	9,500	750	0.05
2	4	14,300	3,000	0.38	11,900	2,250	0.38	9,500	1,500	0.32	7,200	750	0.10
2.5	5	11,500	3,000	0.60	9,500	2,250	0.60	7,600	1,500	0.50	5,700	750	0.15
3	6	9,500	3,000	0.86	8,000	2,250	0.86	6,400	1,500	0.72	4,800	750	0.22
4	8	7,200	3,000	1.54	6,000	2,250	1.54	4,800	1,500	1.28	3,600	750	0.38
5	10	5,700	3,000	2.40	4,800	2,250	2.40	3,800	1,500	2.00	2,900	750	0.60
6	12	4,800	3,000	3.46	4,000	2,250	3.46	3,200	1,500	2.88	2,400	750	0.86

Note

1. These cutting conditions are for general guidance.
2. The figures should be adjusted according to machining shape, purpose and rigidity of machine and work clamping.
3. Recommended ramping angle is under 1° (Max. 3°). In case of ramping angle under 1°, apply standard conditions above. In case of over 1°, reduce (Vf) according to actual machining conditions.

Solid Carbide Endmill for Heat-Resistant Alloy **DV-SCMS Type**

- For Heat resistant alloy
- R0.2-0.3 corner radius
- 6 or 8 flutes , Helix angle 45°

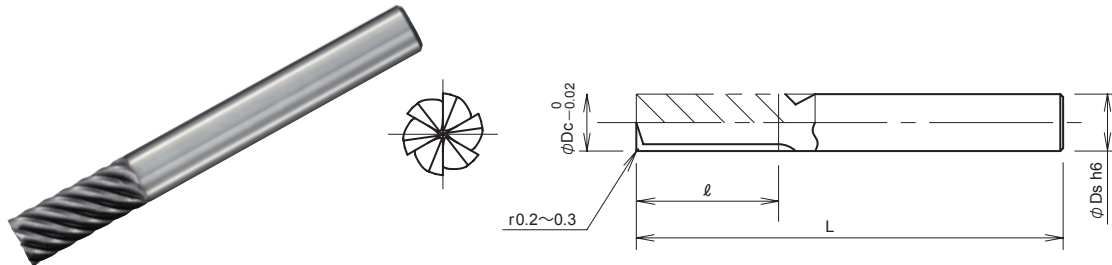
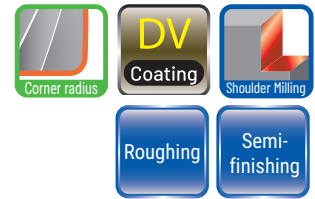

Cat.No.	Stock	No. of Flutes	Dimensions (mm)			
			ϕDc	ℓ	L	ϕDs
DV-SCMS6060	●	6	6	15	50	6
DV-SCMS6080	●		8	20	70	8
DV-SCMS6100	●		10	25	75	10
DV-SCMS8120	●	8	12	26	100	12
DV-SCMS8160	●		16			16

■ **DV-SCMS type Recommended cutting conditions**

Material	Stainless steel (SUS304)		Titanium alloy (Ti-6Al-4V)		Heat resistant alloy (INCO718)	
	Type of machining	<p>$a_p \leq 1.5Dc$ $a_e \leq 0.1Dc$</p>		<p>$a_p \leq 1.5Dc$ $a_e \leq 0.1Dc$</p>		<p>$a_p \leq 1.5Dc$ $a_e \leq 0.05Dc$</p>
ϕDc (mm)	n (min ⁻¹)	Vf (mm/min)	n (min ⁻¹)	Vf (mm/min)	n (min ⁻¹)	Vf (mm/min)
6	8,000	2,100	8,000	2,100	2,100	380
8	6,000	2,100	6,000	2,100	1,600	310
10	4,800	2,100	4,800	2,100	1,300	310
12	4,000	2,100	4,000	2,100	1,100	350
16	3,000	1,700	3,000	1,700	800	260

Note

1. These cutting conditions are for general guidance.
2. The figures should be adjusted according to machining shape, purpose and rigidity of machine and work clamping.
3. Down cutting is recommended.
4. Wet cutting is recommended . For heat resistant alloy , use of cutting fluid is more effective.

Solid Carbide Radius Endmill for Heat-Resistant Alloy DV-OCSAR Type

- For Heat resistant alloy, Titanium alloy
- 4 flutes
- Helix angle 42° - 45°

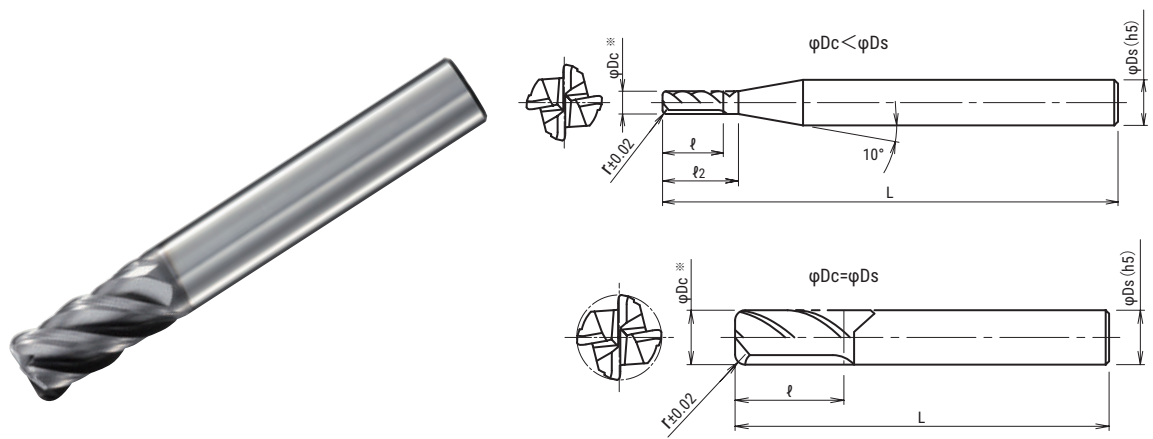
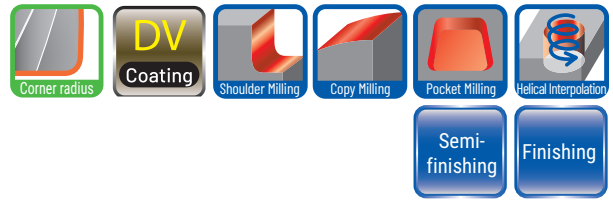

Cat.No.	Stock	Dimensions (mm)					
		r	φDc	ℓ	ℓ2	L	φDs
DV-OCSAR4030-05	●	0.5	3	8	10	60	6
DV-OCSAR4040-05	●		4	11	13		
DV-OCSAR4040-10	●						
DV-OCSAR4050-05	●	0.5	5	13	15		
DV-OCSAR4050-10	●	1					
DV-OCSAR4060-05	●	0.5	6	19	75		
DV-OCSAR4060-10	●	1					
DV-OCSAR4080-05	●	0.5	8	22	80	10	
DV-OCSAR4080-10	●	1					
DV-OCSAR4080-20	●	2	10	26	100	12	
DV-OCSAR4100-05	●	0.5					
DV-OCSAR4100-10	●	1	12	26	110	16	
DV-OCSAR4100-20	●	2					
DV-OCSAR4120-05	●	0.5	16	32	125	20	
DV-OCSAR4120-10	●	1					
DV-OCSAR4120-20	●	2	20	38			
DV-OCSAR4120-30	●	3					
DV-OCSAR4160-10	●	1	16	32	110	16	
DV-OCSAR4160-20	●	2					
DV-OCSAR4160-30	●	3	20	38	125	20	
DV-OCSAR4200-10	●	1					
DV-OCSAR4200-20	●	2	20	38			
DV-OCSAR4200-30	●	3					

■ Tolerance (mm)

Tool dia. (φDc)	Tolerance (φDc)
≤ dia. 6	0 -0.015
> dia. 6	0 -0.02

Solid Carbide Radius Endmill for Heat-Resistant Alloy**DV-OCSAR Type**

■ **DH-OCHB type Recommended cutting conditions**

● **Side milling**

Material	Stainless steel (SUS304, 316, 317)17Cr系		Titanium alloy (Ti-6Al-4V)		Heat resistant alloy (INCO718)	
Type of machining						
	$a_p \leq 1.5D_c$ $a_e \leq 0.1D_c$		$a_p \leq 1.5D_c$ $a_e \leq 0.1D_c$		$a_p \leq 1.5D_c$ $a_e \leq 0.1D_c$	
ϕD_c (mm)	n (min ⁻¹)	V_f (mm/min)	n (min ⁻¹)	V_f (mm/min)	n (min ⁻¹)	V_f (mm/min)
3	11,000	1,200	11,000	1,200	4,200	320
4	8,000	1,200	8,000	1,200	3,200	320
5	6,400	1,200	6,400	1,200	2,500	320
6	5,400	1,200	5,400	1,200	2,100	320
8	4,000	1,200	4,000	1,200	1,600	320
10	3,200	1,300	3,200	1,300	1,300	320
12	2,700	1,300	2,700	1,300	1,100	280
16	2,000	960	2,000	960	800	200
20	1,600	770	1,600	770	640	160

Note

1. These cutting conditions are for general guidance.
2. The figures should be adjusted according to machining shape, purpose and rigidity of machine and work clamping.
3. Down cutting is recommended.
4. Wet cutting is recommended . For heat resistant alloy , use of cutting fluid is more effective.

● **Slot milling**

Material	Stainless steel (SUS304)		Titanium alloy (Ti-6Al-4V)		Heat resistant alloy (INCO718)	
Type of machining						
	$a_p \leq D_c$		$a_p \leq D_c$		$a_p \leq 0.3D_c$	
ϕD_c (mm)	n (min ⁻¹)	V_f (mm/min)	n (min ⁻¹)	V_f (mm/min)	n (min ⁻¹)	V_f (mm/min)
3	8,500	540	8,500	540	3,200	160
4	6,400	580	6,400	580	2,400	170
5	5,100	600	5,100	600	1,900	175
6	4,200	600	4,200	600	1,600	180
8	3,200	640	3,200	640	1,200	190
10	2,500	630	2,500	630	950	190
12	2,100	630	2,100	630	800	160
16	1,600	480	1,600	480	600	120
20	1,300	390	1,300	390	480	100

Note

1. These cutting conditions are for general guidance.
2. The figures should be adjusted according to machining shape, purpose and rigidity of machine and work clamping.
3. Wet cutting is recommended . For heat resistant alloy , use of cutting fluid is more effective. .

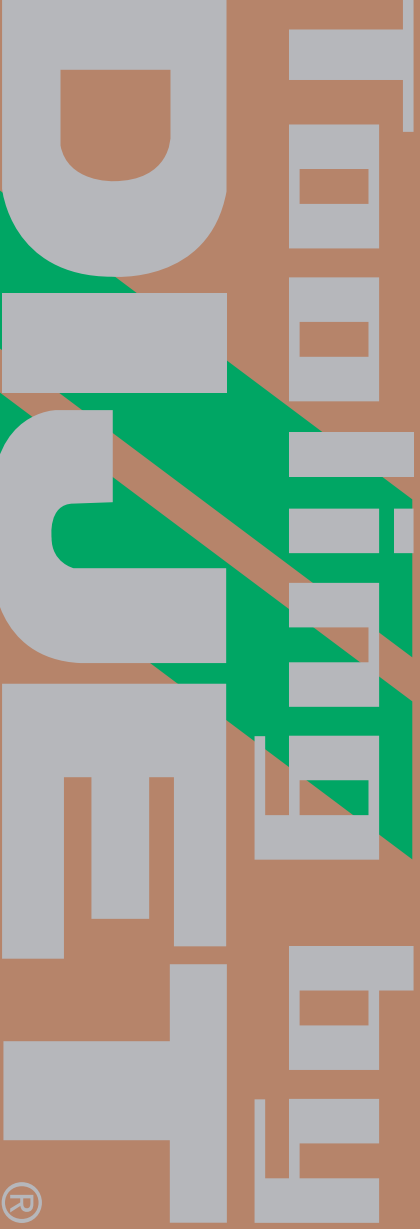

GRADES

DIJET Grades for Milling Tools

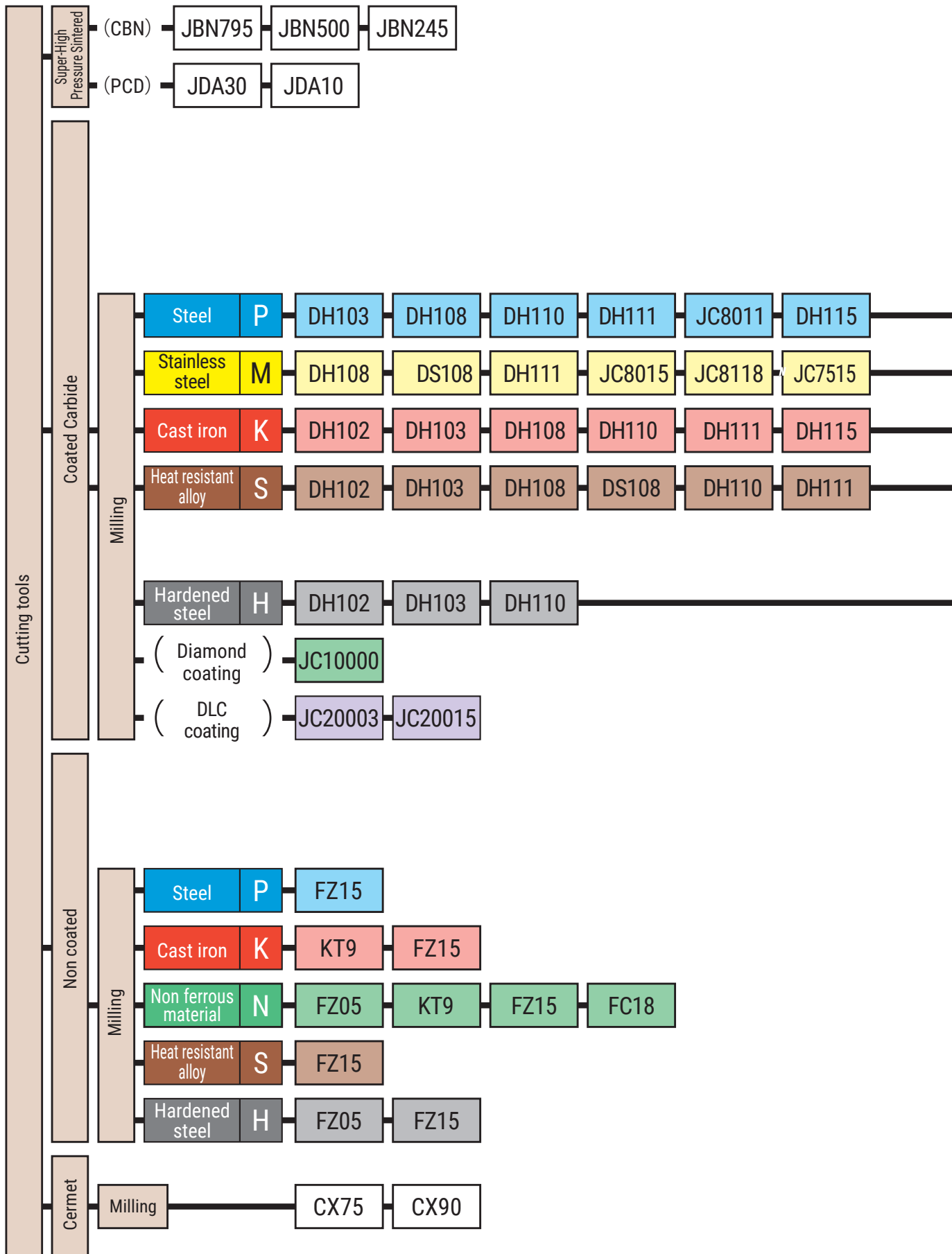

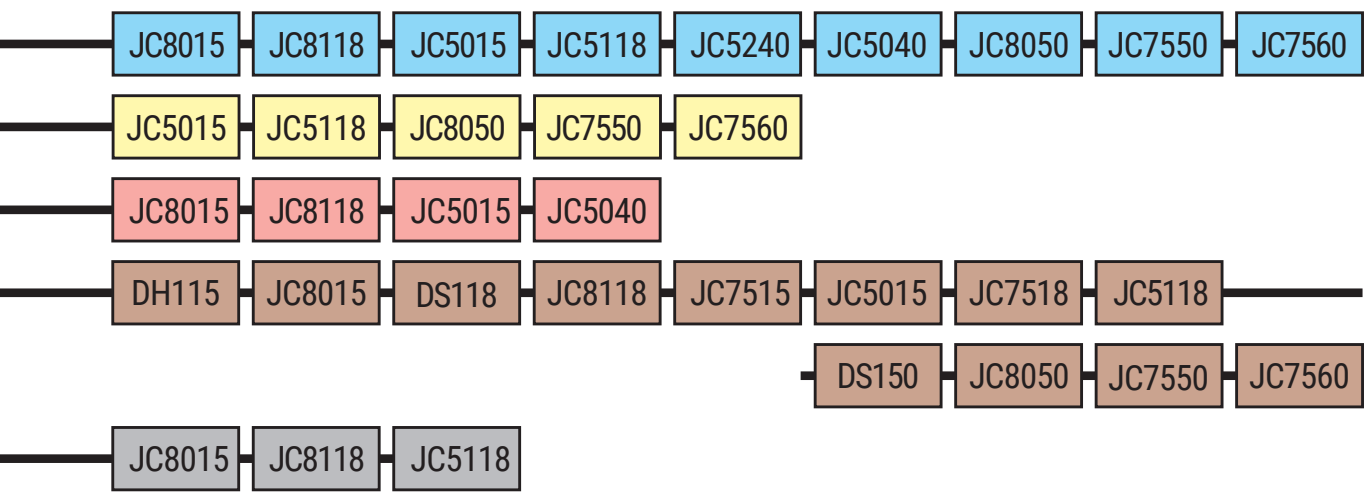

DIJET Grades for Milling Tools

Material		P					M					K					
Application		Finishing ← → Roughing					Finishing ← → Roughing					Finishing ← → Roughing					
ISO		P01	P10	P20	P30	P40	M01	M10	M20	M30	M40	K01	K10	K20	K30		
PVD coating	DH	DH103	DH108	DH110	DH111	DH115	DH108	DH111				DH102	DH103	DH108	DH110	DH111	DH115
	DS						DS108										
	JC8000 (DV)	JC8011	JC8015	JC8118	JC8050		JC8015	JC8118	JC8050			JC8015	JC8118				
	JC7500			JC7550	JC7560		JC7515		JC7550	JC7560							
	JC5000 (DZ)		JC5015	JC5118	JC5240	JC5040	JC5015	JC5118				JC5015		JC5240			
DLC coating																	
Diamond coating																	
Non coated												KT9	FZ15				
Cermet		CX75	CX90				CX75					CX75					
Super-High Pressure Sintered	CBN											JBN795	JBN500	JBN245			
	Diamond																

DIJET Grades for Milling Tools

Material		N				S				H																							
Application		Finishing ← → Roughing				Finishing ← → Roughing				Finishing ← → Roughing																							
ISO		N01	N10	N20	N30	S01	S10	S20	S30	H01	H10	H20	H30																				
PVD coating	DH					DH102				DH102				DH103				DH108				DH110				DH111				DH115			
	DS									DS108				DS118				DS150															
	JC8000 (DV)									JC8015				JC8118				JC8050				JC8015				JC8118							
	JC7500									JC7515				JC7518				JC7550				JC7560											
	JC5000 (DZ)									JC5015				JC5118												JC5118							
DLC coating		JC20003											JC20015																				
Diamond coating		JC10000																															
Non coated		FZ05																				FZ05								FZ15			
		KT9																												FZ15			
			FZ15																														
				FC18																													
Cermet																																	
Super-High Pressure Sintered	CBN																					JBN795				JBN500							
	Diamond	JDA30																															
			JDA10																														

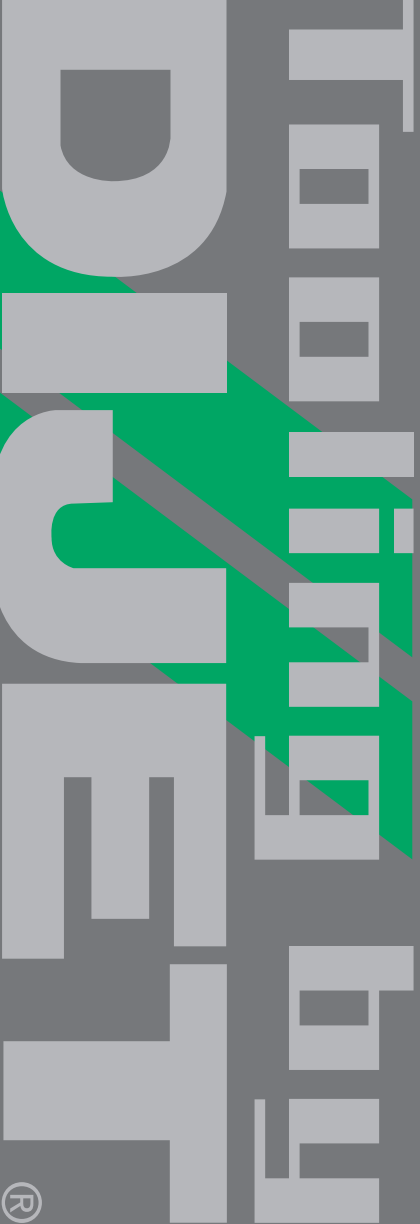

SPARE PARTS

SPARE PARTS

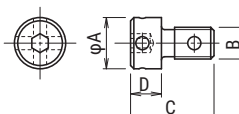
Geometry	Cat.No.	Dimensions						Wrench size
		A	B	C	D	E	α°	
	ADS-513	7.8	M5×0.5	13.0	5.0	—	—	AD-2080
	ADS-514	5.6	M5×0.5	14.5	6.5	—	—	AD-2080

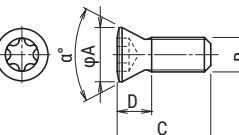
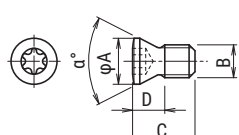
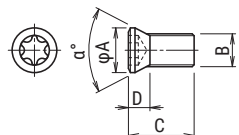
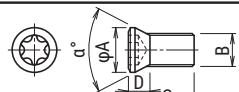
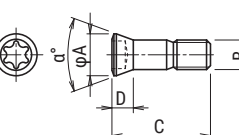
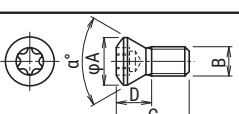
Geometry	Cat.No.	Dimensions						Wrench size	Torque (N·m)
		A	B	C	D	E	α°		
	CSW-206	3.5	M2.5×0.45	5.0	2.4	—	55	T-8	0.9
	CSW-406H	5.0	M4×0.7	6.0	3.6	—	43	T-15	3.6
	CSW-407	5.0	M4×0.7	7.0	3.6	—	43	T-15	3.6
	CSW-408H	5.0	M4×0.7	8.0	3.6	—	43	T-15	3.6
	CSW-513H	7.0	M5×0.8	13.0	4.4	—	63	T-20	5.5
	CSW-510	6.4	M5×0.8	11.0	4.5	—	43	T-20	5.5
	DSW-1840H	2.5	M1.8×0.35	4.0	2.0	—	55	T-6	0.4
	DSW-2045H	3.0	M2×0.4	4.5	2.3	—	60	T-7	0.5
	DSW-2563H	3.45	M2.5×0.45	6.3	2.6	—	55	T-8	1.1
	DSW-306H	4.3	M3×0.5	6.5	3.2	—	55	T-10	1.8
	DSW-307	4.3	M3×0.5	7.5	2.8	—	55	T-10	1.4
	DSW-307H	4.3	M3×0.5	7.6	3.2	—	55	T-10	2.1
	DSW-309H	4.3	M3×0.5	9.0	3.2	—	55	T-10	2.1
	DSW-4075H	5.2	M4×0.7	7.5	3.5	—	55	T-15	3.6
	DSW-408	6.0	M4×0.7	8.5	3.6	—	55	T-15	3.6
	DSW-4085	5.3	M4×0.7	8.5	3.5	—	55	T-15	3.6
	DSW-410H	5.3	M4×0.7	10.0	3.7	—	55	T-15	3.6
	DSW-4510H	6.8	M4.5×0.75	10.0	4.7	—	55	T-20	6.0
	DSW-4512H	6.8	M4.5×0.75	12.5	5.2	—	55	T-20	6.0
	DSW-509	7.0	M5×0.8	9.5	4.9	—	55	T-20	6.1
DSW-511H	7.0	M5×0.8	11.5	4.9	—	55	T-20	6.1	
	ESW-206	3.6	M2.5×0.45	6.0	2.0	—	60	T-8	0.9
	ESW-304	4.0	M3×0.5	4.5	2.0	—	55	T-8	1.4
	ESW-306	4.0	M3×0.5	6.0	2.0	—	55	T-8	1.4
	ESW-307	4.0	M3×0.5	7.5	2.0	—	55	T-8	1.4
	ESW-405	5.3	M4×0.7	5.9	2.7	—	55	T-15	3.1
	ESW-406	5.3	M4×0.7	6.6	2.7	—	55	T-15	3.1
	ESW-408	5.3	M4×0.7	8.0	2.7	—	55	T-15	3.1
	ESW-410	5.3	M4×0.7	10.0	2.7	—	55	T-15	3.1
	ESW-507	6.8	M5×0.8	7.5	3.4	—	55	T-25	5.5
	ESW-508	6.8	M5×0.8	8.2	3.4	—	55	T-25	5.5
	ESW-510	6.8	M5×0.8	10.0	3.4	—	55	T-25	5.5
	FSW-2005H	2.5	M2×0.25	5.0	1.3	—	40	T-6	0.5
	FSW-2506H	3.0	M2.5×0.35	6.6	1.5	—	40	T-7	0.9
	FSW-3007H	3.8	M3×0.35	8.1	2.0	—	40	T-8	1.2
	FSW-3509H	4.7	M3.5×0.6	9.6	2.3	—	40	T-10	2.0
	FSW-4013H	5.8	M4×0.7	13.5	3.3	—	40	T-15	3.0
	FSW-5016H	6.8	M5×0.8	16.4	3.2	—	40	T-20	4.0
	FSW-6020	8.5	M6×1.0	20.0	4.3	—	40	T-30	6.0
	FSW-8025	11.0	M8×1.25	25.0	5.5	—	40	T-40	6.0
	FSW-8025S	11.0	M8×1.25	25.0	5.5	—	40	T-30	6.0
	HSW-614H	10.0	M6×1.0	15.0	7.3	—	60	T-30	7.5

SPARE PARTS

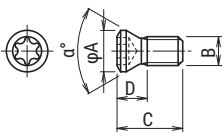
Geometry	Cat.No.	Dimensions						Wrench size	Torque (N•m)
		A	B	C	D	E	α°		
	TSW-2250	3.1	M2.2×0.45	5.0	2.3	—	60	T-7	0.6
	TSW-2556H	3.6	M2.5×0.45	5.6	2.7	—	60	T-8	1.1
	TSW-2567H	3.6	M2.5×0.45	6.7	2.7	—	60	T-8	1.1
	TSW-307H	4.3	M3×0.5	7.6	3.1	—	60	T-10	2.1
	TSW-3509H	5.3	M3.5×0.6	9.0	4.5	—	60	T-15	3.0
	TSW-3510H	5.3	M3.5×0.6	10.0	4.5	—	60	T-15	3.0
	TSW-3512H	5.3	M3.5×0.6	11.5	4.5	—	60	T-15	3.0
	TSW-408	5.5	M4×0.7	8.0	3.3	—	60	T-15	3.1
	TSW-410H	5.3	M4×0.7	10.0	3.6	—	60	T-15	3.5
	TSW-511	7.0	M5×0.8	11.0	5.0	—	60	T-20	5.5
	TSW-612	8.5	M6×1.0	12.0	4.8	—	60	T-25	7.5
	TSW-614H	8.5	M6×1.0	14.0	6.2	—	60	T-25	7.5

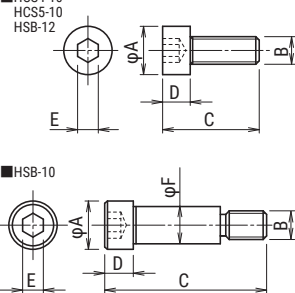
Geometry	Cat.No.	Dimensions						Wrench size	Torque (N•m)
		A	B	C	D	E	F		
	HCS4-10	7.0	M4×0.7	14.0	4.0	3.0	—	—	—
	HCS5-10	8.5	M5×0.8	15.0	5.0	4.0	—	—	—
	HSB-10	17.0	M10×1.5	56.0	10.0	8.0	13	—	—
	HSB-12	18.0	M12×1.75	62.0	12.0	10.0	—	—	—

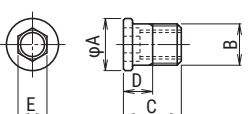
Geometry	Cat.No.	Dimensions						Wrench size	Torque (N•m)
		A	B	C	D	E	F		
	SSW-535	6.3	M5×0.5	7.0	3.1	3.5	—	—	6.5

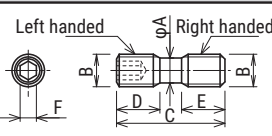
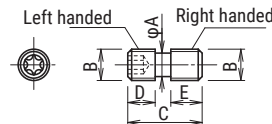
Geometry	Cat.No.	Dimensions						Wrench size	Torque (N•m)
		A	B	C	D	E	F		
	LS-101	4.6	M6×1.0	16.0	6.5	6.5	3.0	—	6.0
	LS-106	4.6	M6×1.0	14.5	6.5	5.0	3.0	—	6.0
	LS-107	4.6	M6×1.0	13.0	5.0	5.0	3.0	—	6.0
	LS-109	5.5	M7×0.75	19.0	7.5	8.0	—	T-25	7.0
	LS-110	4.8	M6×0.75	22.0	8.0	8.0	—	T-15	6.0

SPARE PARTS

Geometry	Cat. No	Dimensions						Wrench size	Torque (N·m)
		A	B	C	D	E	F		
	LS-113	3.7	No.10-32UNF	10.2	4.5	4.1	2.4	—	—

Geometry	Cat. No	Dimensions						Wrench size	Torque (N·m)
		A	B	C	D	E	F		
	SLS-3	6.0	M8×1.0	20.0	8.0	8.0	4.0	—	8.0

Geometry	Cat. No	Dimensions					Wrench size
		A	B	C	D	E	
	LW-020	52.0	15.0	—	—	2.0	—
	LW-025	59.5	18.0	—	—	2.5	—
	LW-030	67.0	20.0	—	—	3.0	—
	LW-035	71.5	22.5	—	—	3.5	—
	LW-040	75.0	25.0	—	—	4.0	—
	LW-050	80.0	28.0	—	—	5.0	—
	A-030	—	60.0	80.0	28.0	3.0	—
	A-07SD	4.0	60.0	80.0	—	—	T-7
	A-08SD	4.0	70.0	80.0	—	—	T-8
	A-10SD	4.0	70.0	95.0	—	—	T-10
	A-20SD	5.0	90.0	105.0	—	—	T-20
	A-25SD	5.0	100.0	105.0	—	—	T-25
	A-06	1.7	34.5	15.0	15.0	—	T-6
	A-07	2.0	34.5	15.0	15.9	—	T-7
	A-08	2.3	39.0	19.0	19.0	—	T-8
	A-10	3.0	40.0	40.0	20.0	—	T-10
	A-15	3.5	45.0	40.0	20.0	—	T-15
	A-20W	4.0	45.0	40.0	20.0	—	T-20
	A-15T	4.0	100.0	80.0	26.0	—	T-15
	A-20	4.0	100.0	100.0	32.0	—	T-20
	A-20L	5.5	200.0	100.0	32.0	—	T-20
	A-25	4.5	100.0	100.0	32.0	—	T-25
	A-27	5.5	100.0	100.0	32.0	—	T-27
	A-30	6.0	100.0	100.0	32.0	—	T-30
	A-40	7.0	100.0	100.0	32.0	—	T-40
	AD-2080	2.0	45.0	35.0	—	—	—

SPARE PARTS

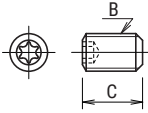
Geometry	Cat. No	Dimensions						Wrench size	Torque (N•m)
		A	B	C	D	E	F		
	RSW-05008	–	M5×0.8	8.0	–	–	–	T-10	–

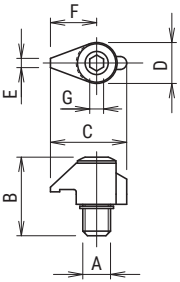
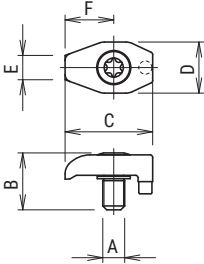
Geometry	Cat. No	Dimensions							Wrench size
		A	B	C	D	E	F	G	
	DCM-1	M5×0.8	13.8	13.8	6.8	2.0	8.5	2.5	–
	DCM-5	M6×1.0	17.0	16.5	8.9	2.0	10.0	3.0	–
	DCM-17	M4.5×0.75	11.7	18.0	10.5	5.0	10.0	–	T-20
	DCM-18	M3.5×0.6	10.0	13.0	7.6	3.0	7.2	–	T-15

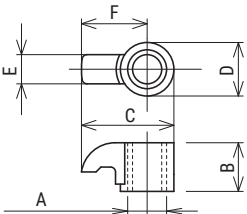
Geometry	Cat. No	Dimensions					
		A	B	C	D	E	F
	DCM-2	M8×1.0	10.0	19.0	11.0	6.0	13.5

Shape	Cat. No
	MOLY



INDEX

INDEX

Cat.No	Name	Page
--------	------	------

A

A-06	Wrench for PME,MPM,BNM06,RNM06	A181,A182,A270,A283
A-07	Wrench for BNM08,RNM08,TLZD,TEZD	A270,A283,B022,B028,B040
A-08	Wrench for MQT,GMX,MXG,QXP,MQX,BNM10,RNM10,TLZD,TEZD	A031,A105~A107,A121~123,A270,A272,A283,A285, B022,B028,B040
A-10	Wrench for SKG09,EXSAP11,BNM12,RNM12,TEZD,TLZD	A066~A068,A202~A204,A270,A272,A283,A285,B023, B029,B041,B042
A-15	Wrench for SKG10,EXSKS07,EXSAP17,SSV,BNM16,RNM16,SDH,ALX, TLZD,TEZD	A025~A028,A051,A083,A207,A208,A247,A248,A270,A272, A283,A285,A322,A323,A356,A357,B023,B029,B042,B043
A-15T	Wrench for SKG10,EXSKS07,EXSAP17,SSV,SDH,ALX,TLZD,TEZD	A065,A206,A246,A320.A321,A355
A-20	Wrench for SKG14,EXSKS09,EXSIX,HDM,HEP	A053,A085,A236,A321,A344,
A-20W	Wrench for BNM20,RNM20	A025~A028,A270~A272,A284,A285
A-30	Wrench for BNM25,RNM25	A025~A028,A271,A272,A284,A285
A-40	Wrench for	A025~A028,A271,A272,A284,A285
ALX○○○○R-22	AERO CHIPPER	A355
ALXM○○○○S○○	AERO CHIPPER	A356

B

BNM□-○○○○○○S-○○	MIRROR BALL	A270
BNM□-○○○○○○S-○○C	MIRROR BALL	A270
BNM□-○○○○○○T-○○	MIRROR BALL	A270
BNM□-○○○○○○T-○○C	MIRROR BALL	A270
BNM-○○○	Insert for MIRROR BALL - BNM/MBX type	A271
BNM-○○○-S	Insert for MIRROR BALL - BNM/MBX type	A276
BNM-○○○-SS	Insert for MIRROR BALL - BNM/MBX type	A274
BNM-○○○-TG	Insert for MIRROR BALL - BNM/MBX type	A276
BNM-○○○-TS	Insert for MIRROR BALL - BNM/MBX type	A275

C

CSW-408H	Screw for SDH	A322,A323
CSW-513H	Screw for SKG14,EXSKS09,EXSIX	A053,A085,A236

D

DCM-17	Clamp set for HDM,HEP	A320
DCM-18	Clamp set for HDM	A320,A320
DH-OCHB4○○○	ONE CUT BALL 70 - Solid carbide endmill	C025
DS-○○	Spanner	A029,A272,A285,A364,A369,A371,A374
DSW-1840H	Screw for PME,MPM	A182,A183
DSW-2045H	Screw for TLZD,TEZD	B022,B028,B040
DSW-2563H	Screw for MQT,MQX,QXP	A031,A121,A122,A123
DSW-306H	Screw for MSG09	A068
DSW-307H	Screw for SKG09,MSG09,TLZD,TEZD	A066~A068,B023,B029,B041,B042
DSW-309H	Screw for TLZD,TEZD	B023,B029,B042
DSW-4075H	Screw for SSV,ALX	A246~A248,A356
DSW-4085	Screw for ALX,MAL	A355~A357
DSW-410H	Screw for HDM,SDH	A320~A323
DSW-4512H	Screw for HDM	A320,A321
DV-OCSAR4○○○-○○	Solid Carbide Radius Endmill for Heat-Resistant Alloy	C028
DV-SCMS○○○○	Solid Carbide Endmill for Heat-Resistant Alloy	C027

Cat.No	Name	Page
--------	------	------

E

ENMQ100312ZER	Insert for QMMAX GII- GMX/MXG type	A108
ENMU100312ZER-HL	Insert for QMMAX GII- GMX/MXG type	A108
ENMU100412ZER-PH	Insert for QMMAX GII- GMX/MXG type	A108
ENMU100412ZER-SL	Insert for QMMAX GII- GMX/MXG type	A108
EOHW0602○○ZTR	Insert for QM MILL - PME/PME-LS/MPM type	A183
EOMT0602○○ZER	Insert for QM MILL - PME/PME-LS/MPM type	A183
EOMW060210ZER	Insert for QM MILL - PME/PME-LS/MPM type	A183
EPHW100316ZTR	Insert for QM MAX - MQX/QXP type	A124
EPMT1003○○ZER	Insert for QM MAX - MQX/QXP type	A124
EPMW100312Z□R	Insert for QM MAX - MQX/QXP type	A124
EXSAP-○○○○-○○-S○○	EXTREME SAP 17	A207
EXSAP-○○○○-11-○○-S○○+A	EXTREME SAP 11	A203
EXSAP-○○○○R-11-○○	EXTREME SAP 11	A202
EXSIX-○○○○R-○○	SHOULDER SIX	A236
EXSKS-○○○○R-○○	SKS EXTREME 09	A084
EXSKS-○○○○R-07-○○	SKS EXTREME 07	A082
EXSKS-○○○○R-05-○○	SKS EXTREME 05	A080
EZH5D○○○○S○○	EZ HARD DRILL	B003
EZH5D○○○○S○○-LS	EZ HARD DRILL	B003

F

FJVA4○○○S○○-R250	FUJI BARREL - Solid carbide endmill	A030
FRM-○○○-R○○	Insert for MIRROR RADIUS ENDMILL - RNM/MRX type	A289
FSW-2005H	Screw for BNM6,RNM6	A270,A283
FSW-2506H	Screw for BNM8,RNM8	A270,A283
FSW-3007H	Screw for BNM10,RNM10	A270,A272,A283,A285
FSW-3509H	Screw for BNM12,RNM12	A270,A272,A283,A285
FSW-4013H	Screw for BNM16,RNM16	A270,A272,A283,A285
FSW-5016H	Screw for BNM20,RNM20	A270,A271,A272,A284,A285
FSW-6020	Screw for BNM25,RNM25	A271,A272,A284,A285
FSW-8025S	Screw for BNM30,RNM30	A271,A272,A284,A285

G

GMX-○○○○-○○-S○○	QMMAX GII	A106
GMX-○○○○R-○○	QMMAX GII	A105

H

HDM-○○○○-○○R-○○	SUPER DIEMSTER	A320,A321
HEP-○○○○R-○○-○○	HEPTA MILL	A344
HRM-○○○-R○○	Insert for MIRROR RADIUS ENDMILL - RNM/MRX type	A288

K

KRM-○○○-R10-BR○○	Insert for MIRROR BARREL - MRX type	A025
------------------	-------------------------------------	------

L

LRM-○○○-R○○-BR○○	Insert for MIRROR BARREL - MBX type	A028
------------------	-------------------------------------	------

INDEX

Cat.No	Name	Page
--------	------	------

M

M10x1.5x25	ARBOR SET BOLT for EXSKS09,HEP	A084,A344
M10x1.5x35	ARBOR SET BOLT for SKG	A050,A053
M12x1.75x30	ARBOR SET BOLT for SKG,EXSAP11,EXSAP17,EXSIX,SSV	A050,A053,A066,A202,A206,A236,A246
M12x1.75x35	ARBOR SET BOLT for EXSKS07	A082
M12x1.75x40	ARBOR SET BOLT for EXSKS09,HEP	A084,A344
M16x2x25	ARBOR SET BOLT for EXSAP17	A206
M16x2x30	ARBOR SET BOLT for EXSIX,SSV	A236,A246
M16x2x45	ARBOR SET BOLT for EXSKS09	A084
M20x2.5x40	ARBOR SET BOLT for EXSAP17,EXSIX,SSV	A206,A236,A246
M20x2.5x45	ARBOR SET BOLT for EXSKS09,HEP	A084,A344
MAGNETISER	MAGNETISER	A183
MAL-○○○○-M○○	AERO-CHIPPER	A357
MBX-○○○-M○○	MIRROR BALL	A028,A272
MEX-○○○○-07-M○○	SKS EXTREME 07	A082
MEX-○○○○-05-M○○	SKS EXTREME 05	A080
MPM-○○○○-M○○	QMMILL	A182
MQT-○○○○A○○-M○○	QMMAX MQT	A031
MQX-○○○○-M○○	QMMAX	A123
MRX-○○○-M○○	MIRROR RADIUS	A025,A285
MSG-○○○○-09-M○○	SKS-GII 09	A068
MSG-○○○○-10-M○○	SKS-GII 10	A051
MSN-M○○-○○○-S○○C	MSN Carbide Shank	A376
MSN-M○○-○○○S-S○○C	MSN Carbide Shank	A377
MSN-M○○-○○○T-S○○C	MSN Carbide Shank	A375
MSX-○○○○-11-M○○	EXTREME SAP 11	A204
MSX-○○○○-M○○	EXTREME SAP 17	A208
MTP-○○○-M○○	MIRROR BARREL	A026,A027
MXF-○○○○-M○○	DIEMASTER 5G	A303
MXG-○○○○-M○○	QMMAX GII	A107

P

PME○○○○S○○	QMMill	A181
PME○○○○S○○-LS	QMMill	A181

Q

QXP-○○○○-S○○+A	QMMAX	A122
QXP-○○○○R	QMMAX	A121

Cat.No	Name	Page
--------	------	------

R

RD□T○○□□M□□	Insert for SUPER DIEMSTER - HDM/SDH type	A324
RD□T○○○○M□□	Insert for SUPER DIEMSTER - HDM/SDH type	A324
RDGT○○□□M□□-AL	Insert for SUPER DIEMSTER - HDM/SDH type	A325
RDGT○○○○M□□-AL	Insert for SUPER DIEMSTER - HDM/SDH type	A325
RDMT○○○○M□□-ML	Insert for SUPER DIEMSTER - HDM/SDH type	A324
RDMW○○□□M□□	Insert for SUPER DIEMSTER - HDM/SDH type	A324
RDMW○○○○M□□	Insert for SUPER DIEMSTER - HDM/SDH type	A324
RNM□-○○○○○○S-○○	MIRROR RADIUS ENDMILL	A283,A284
RNM□-○○○○○○S-○○C	MIRROR RADIUS ENDMILL	A283,A284
RNM□-○○○○○○T-○○C	MIRROR RADIUS ENDMILL	A283,A284
RNM□-○○○○○○U-○○C	MIRROR RADIUS ENDMILL	A283,A284
RNM-○○-○○	Insert for MIRROR RADIUS ENDMILL - RNM/MRX type	A286,A287

S

SDET090312ZDER-SM	Insert for SKS-GII 09 type	A069
SDEW090312ZER	Insert for SKS-GII 09 type	A069
SDH-○○○○-○○-M○○	SUPER DIEMSTER	A322,A323
SEHH○○○○	ONE CUT 70 - Solid carbide endmill	C003
SEHH○○○○-○○	ONE CUT 70 - Solid carbide endmill	C004,C005
SEHL○○○○	ONE CUT 70 - Solid carbide endmill	C007
SEHM○○○○	ONE CUT 70 - Solid carbide endmill	C006
SEHS○○○○	ONE CUT 70 - Solid carbide endmill	C003
SFSB○○○○	HARD 1 BALL - Solid carbide ball nose endmill	C021
SFSB○○○○-S6	HARD 1 BALL - Solid carbide ball nose endmill	C021
SFSR○○○○-○○	HARD 1 RADIUS - Solid carbide radius endmill	C012
SFSR○○○○S○○-○○-○○	HARD 1 RADIUS - Solid carbide radius endmill	C013
SFSR○○○○S○○-R02-○○	HARD 1 RADIUS - Solid carbide radius endmill	C014
SKG-○○-○○-09-S	SKS-G○ 09	A067
SKG-○○R-09-○○	SKS-G○ 09	A066
SKG-○○○○R-10-○○	SKS-G○ 10	A050
SKG-○○○○R-14-○○	SKS-G○ 14	A053
SMAL-○○○○-M○○	S HEAD - Solid carbide modular head	A369
SMHB-○○○○-M○○	S HEAD - Solid carbide modular head	A374
SMSA-○○○○R○○○○-M○○	S HEAD - Solid carbide modular head	A364
SMSR-○○○○R○○-M○○	S HEAD - Solid carbide modular head	A371
SPET100415ZPER-SM	Insert for SKS-GII 10 type	A052
SPMT100415ZP○R-PM	Insert for SKS-GII 10 type	A052
SPMT100415ZP○R-SM	Insert for SKS-GII 10 type	A052
SPMT140520ZP○R-PM	Insert for SKS-GII 14 type	A054
SPNW100415ZTR	Insert for SKS-GII 10 type	A052
SPNW140515ZTR	Insert for SKS-GII 14 type	A054
SSV-○○○○-○○-S○○+A	SIC-EVO	A248
SSV-○○○○-M○○	SIC-EVO	A247
SSV-○○○○R-○○	SIC-EVO	A246
STLP-4○○○T○○○R-○○	S HEAD - Solid carbide modular head	A029

INDEX

Cat.No	Name	Page
--------	------	------

T

TEZ○○○○	Insert for TA-EZ Drill - TEZD type	B040~B044
TEZD○○○○S○○-ML	TA-EZ Drill 5D	B040~B044
TEZD○○○○S○○-MS	TA-EZ Drill 3D	B040~B044
TEZD○○○○S○○-XL	TA-EZ Drill 8D	B040~B044
TEZ○○○○S	Insert for TA-EZ Drill - TEZD type	B040,B041
TLD3DCH○○○○S○○	FLAT Drill 3D	B012,B013
TLD5DCH○○○○S○○	FLAT Drill 5D	B014,B015
TLDM○○○	FLAT Drill 2D	B006,B007
TLDM○○○-S6	FLAT Drill 2D	B006
TLZ○○○○	Insert for TLZD Drill - TLZD type	B022,B023,B028,B029
TLZD○○○○-M○	TLZD Drill	B028,B029
TLZD○○○○S○○-SS	TLZD Drill	B022,B023
TNM-○○○○-NR○BR○○	Insert for MIRROR BARREL - MTP type	A026
TPM-○○○-NR2T30BR○○○	Insert for MIRROR BARREL - MTP type	A027
TQC-○○	Torque Control Wrench	A277
TSW-2556H	Screw for MQT,QXPS,MQX,SDH,TLZD,TEZD	A031,A122,A123,A322,A323,B022,B028,B040
TSW-2567H	Screw for GMX,MXG,TLZD,TEZD	A105~A107,B023,B029,B041
TSW-307H	Screw for EXSAP11	A202~A204
TSW-3509H	Screw for SKG10	A050,A051
TSW-3510H	Screw for TLZD,TEZD	B023,B029,B042,B043
TSW-3512H	Screw for SSE45,SSD90,TLZD,TEZD	B023,B029,B043
TSW-410H	Screw for EXSKS07,EXSAP17,EXTDM	A083,A206~A208

W

WNHU04T310ZER	Insert for DIEMASTER 5G - MXF/XFG type	A303
WNMU050320ZER-PM	Insert for SKS EXTREME - EXSKS 05 type	A081
WNMU070620ZER-PM	Insert for SKS EXTREME - EXSKS 07 type	A083
WNMU090720ZER-PM	Insert for SKS EXTREME - EXSKS 09 type	A085
WNMU090828ZER-PL	Insert for SKS EXTREME - EXSKS 09 type	A085

X

XDHW080610ZER-W	Insert for HEPTA MILL - HEP type	A345
XDMT080620ZER	Insert for HEPTA MILL - HEP type	A345
XDMT080620ZER-ML	Insert for HEPTA MILL - HEP type	A345
XDMT080708ZER	Insert for HEPTA MILL - HEP type	A345
XDMW080620ZTR	Insert for HEPTA MILL - HEP type	A345
XDMW080635ZTR-S	Insert for HEPTA MILL - HEP type	A345
XFG-○○○○R-○○	DIEMASTER 5G	A302
XOGT1605○○PDR	Insert for AERO CHIPPER - ALX/MAL type	A358
XPH□100308ZER-R	Insert for QM MAX - MQT type	A032

Y

YCMU0907○○ZER-PM	Insert for SHOULDER SIX - EXSIX type	A237
YOHW0602○○ZER-12	Insert for QM MILL - PME/PME-LS/MPM type	A183
YPHW1003○○ZER-15	Insert for QM MAX - MQX/QXP type	A032,A125
YPHW100308ZER-F	Insert for QM MAX - MQX/QXP type	A032,A125
YPHW100308ZTR-F1	Insert for QM MAX - MQX/QXP type	A032,A125
YPHW100320ZER-24	Insert for QM MAX - MQX/QXP type	A125

Cat.No	Name	Page
--------	------	------

Z

ZNGU1105○○ZER-PM	Insert for EXTREME SAP - EXSAP 11/MSX 11 type	A205
ZNGU1105○○ZER-SL	Insert for EXTREME SAP - EXSAP 11/MSX 11 type	A205
ZNGU1709○○ZER-PM	Insert for EXTREME SAP - EXSAP 17/MSX 17 type	A209
ZOMT0602○○ZER-PL	Insert for QM MILL - PME/PME-LS/MPM type	A183
ZOMT1605○○ZER-PM	Insert for SIC-EVO - SSV type	A249
ZPMT1003○○ZER-NL	Insert for QM MAX - MQX/QXP type	A125
ZPMT1003○○ZER-PL	Insert for QM MAX - MQX/QXP type	A125
ZPMT1003○○ZER-SL	Insert for QM MAX - MQX/QXP type	A125

PLANTS & OFFICES IN JAPAN



● OSAKA PLANT



● MIE POWDER PLANT (raw materials)



● MIE PLANT (carbide blanks)



● MIE PLANT (tools)



● TONDABAYASHI PLANT (raw materials)



Break Through



DIJET INDUSTRIAL CO., LTD.

Headquarters 2-1-18, Kami-Higashi, Hirano-ku, Osaka 547-0002, Japan Phone: 81-6-6791-6781 Fax: 81-6-6793-1221



DIJET GmbH (Europe)

Immermannstr.9 40210 Düsseldorf, Germany
Phone. 49-211-50088820, 50088822 Fax. 49-211-50088823

DIJET INDUSTRIAL CO., LTD. (Bangkok Representative Office)

699 Srinakarindr Road, Modernform Tower 15th Floor,
Kweang Suanluang, Khet Suanluang, Bangkok 10250, Thailand
Phone. 66-2-722-8258, 8259 Fax. 66-2-722-8260

DIJET INDUSTRIAL CO., LTD. (Shanghai Representative Office)

Room No.712 Tomson Commercial Building., 710 Dongfang Rd.,
Shanghai 200122, China
Phone. 86-21-5058-1698 Fax. 86-21-5058-1699

DIJET INDUSTRIAL CO., LTD. (Guandong Representative Office)

Rm.903, No.98, Zhenan East-Road, Changan Town, Dongguan City,
Guangdong Provence 523850, China
Phone. 86-769-8188-6001 Fax. 86-769-8188-6608

DIJET INDUSTRIAL CO., LTD. (Chengdu Office)

RM.No.2015, No.1BLDG.A-B Stand, Hi-Tech Incubation Garden, No.1480
Tianfu Avenue North, Hi-Tech District, Chengdu City, Sichuan, P.R.CHINA
Phone. 86-28-8511-4585 Fax. 86-28-8511-2758

DIJET INDUSTRIAL CO., LTD. (Wuhan Office)

B-2513, Jiayu Jiinyin Business Masion, No.10 Chuangye Road,
Wuhan Eco. & Tech. Development Zone, Wuhan City, Hubei 430056, China
Phone. 86-27-8773-8919 Fax. 86-27-8773-8959

DIJET INDUSTRIAL CO., LTD. (Mumbai Representative Office)

305, Mahant Chambers Plot No.315, Road No.34, Wagle Estate
MIDC Industrial Area, Thane (W),400604,India
Phone. 91-22-4012-1231 Fax.91-22-4024-0919

DIJET Incorporated (U.S.A.)

45807 Helm Street, Plymouth, MI 48170 U.S.A.
Phone. 1-734-454-9100 Fax. 1-734-454-9395